



# MONKIE KID 悟空小侠™

80016

1



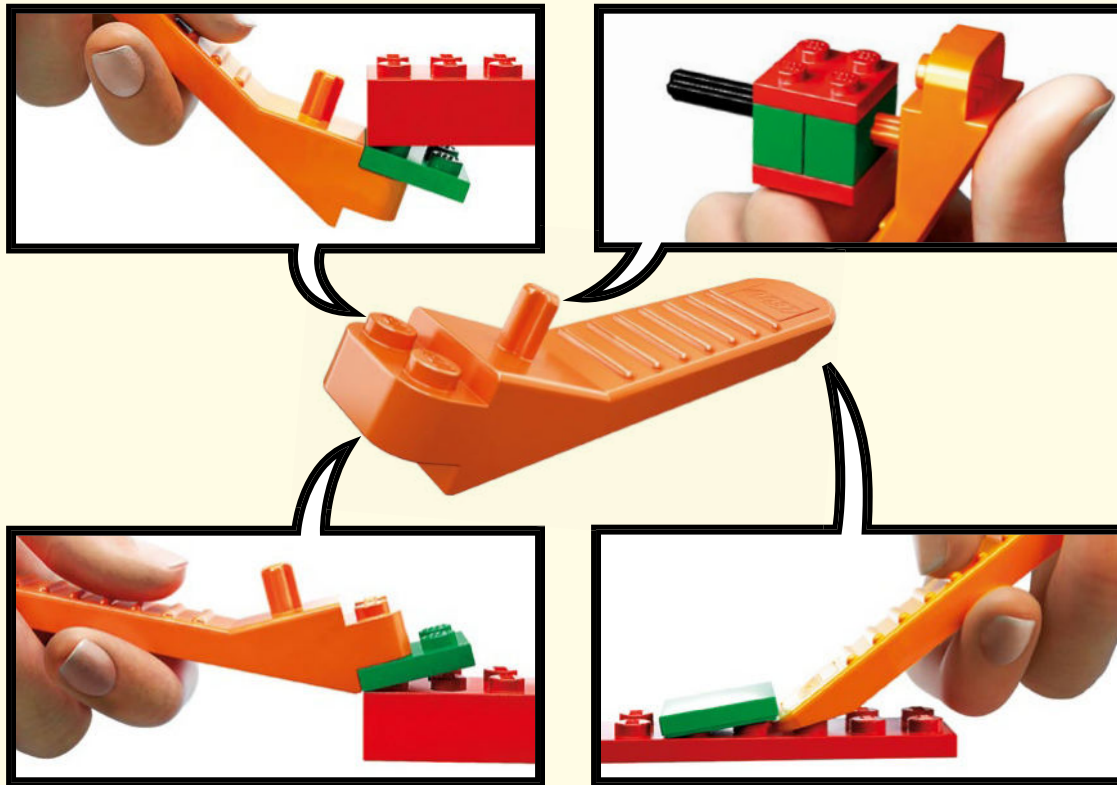

[LEGO.com/brickseparator](https://LEGO.com/brickseparator)



- 1 Scan the code on the front cover  
 Scanne den Code auf der Titelseite  
 Scanne le code sur la page de couverture  
 Scanner le code sur la page couverture  
 Scansiona il codice sulla copertina  
 Escanea el código de la portada  
 Faz scan do código na frente da capa  
 Olvasd be a borítón látható kódot!  
 Noskenē kodu uz priekšējā vāka  
 扫描封面上的二维码



- 2 Get Instructions PLUS  
 Hol dir Instructions PLUS  
 Obtiens les instructions PLUS  
 Obtenir les Instructions PLUS  
 Scarica Instructions PLUS  
 Descubre Instructions PLUS  
 Obtém Instrukções PLUS  
 Szerezd be az Instructions PLUS kiegészítőt!  
 Saņem "Instructions PLUS"  
 获取更多说明

**LEGO.com/apps**

Check for compatibility  
 Kompatibilität prüfen  
 Vérifier la compatibilité  
 Controlla la compatibilità  
 Comprueba tu compatibilidad

Verificar a compatibilidade  
 Ellenőrizd a kompatibilitást  
 Pārbaudīt saderību  
 检查兼容性

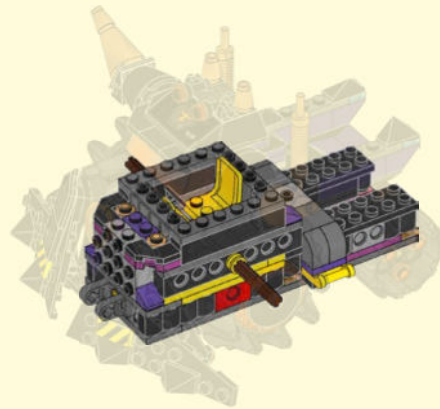
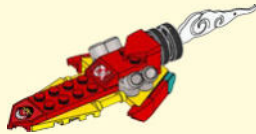

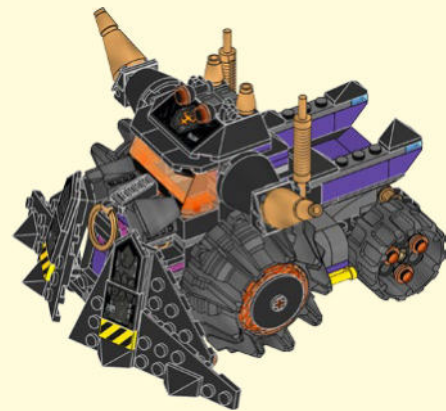
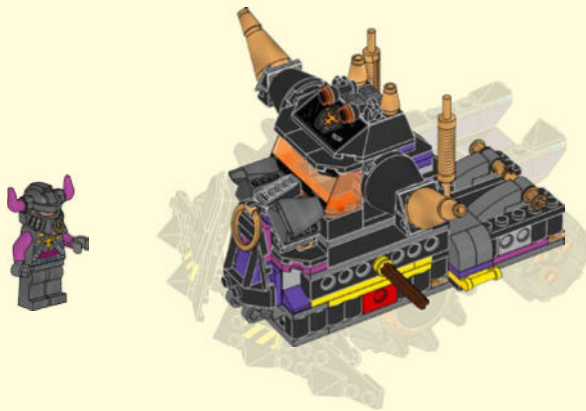





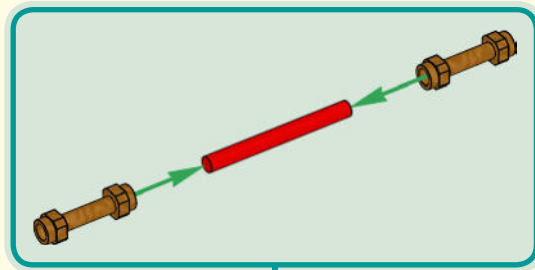
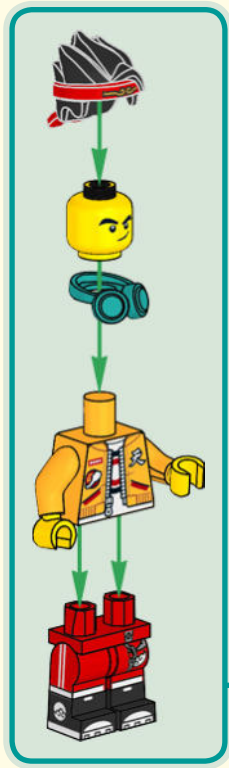
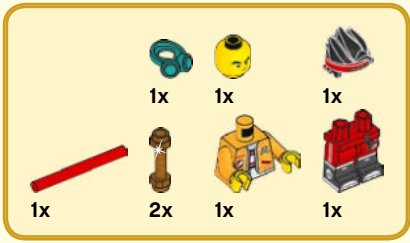



# MONKIE KID



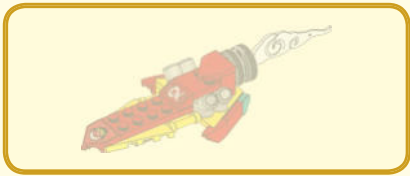

1x

1

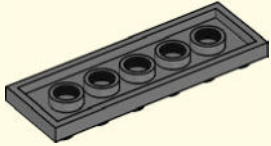

2x

2

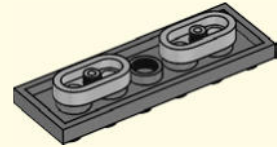

2x

3

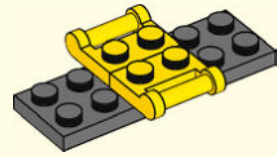

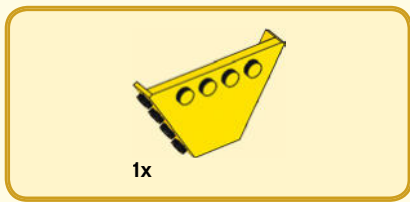

4

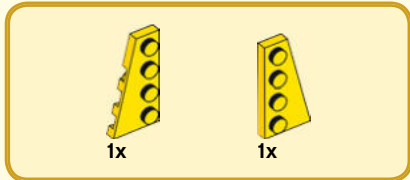
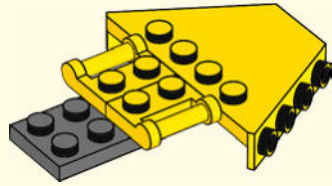

5

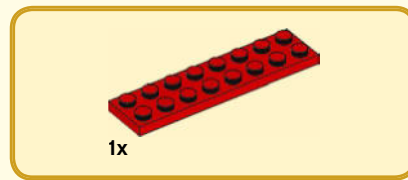
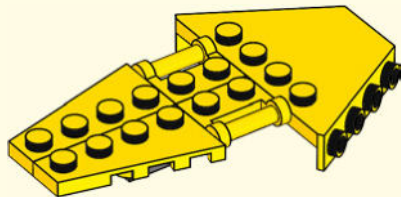

6

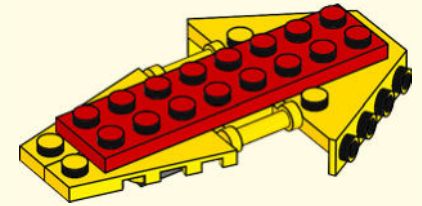

7

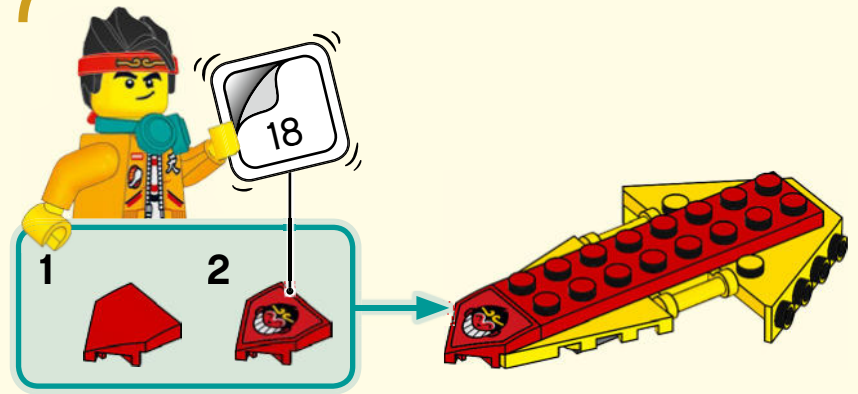

1x

2x

8

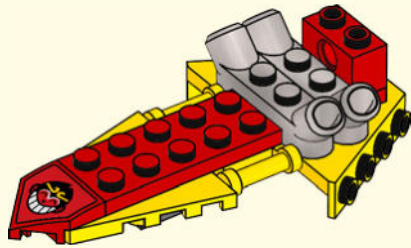

1x

9

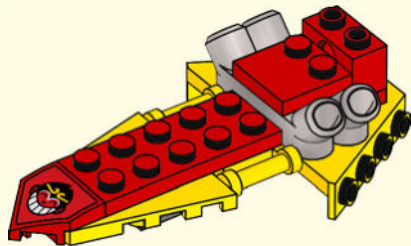

1x

10

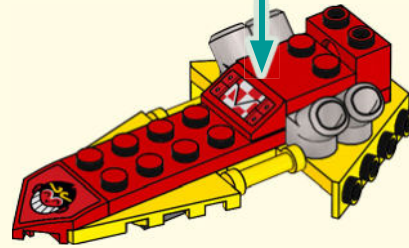
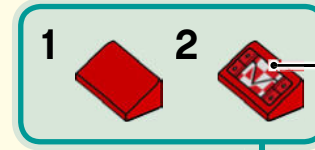

1x

11

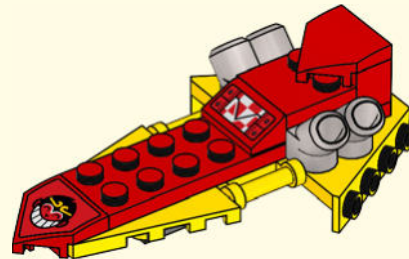

1x

12

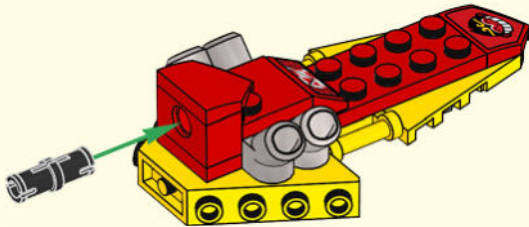

1x

13

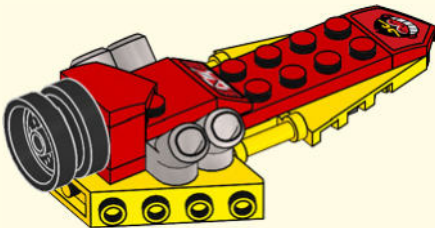

1x

14

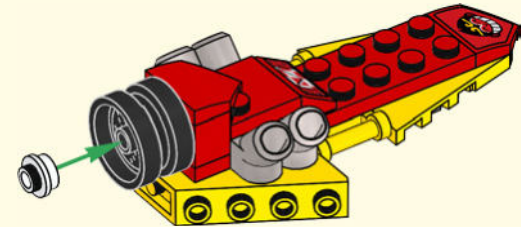

1x



1x



1x

15

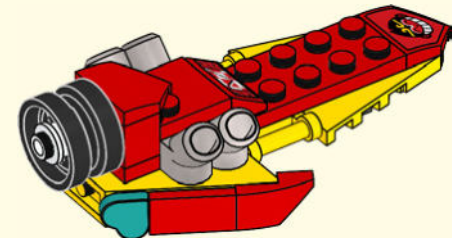



16

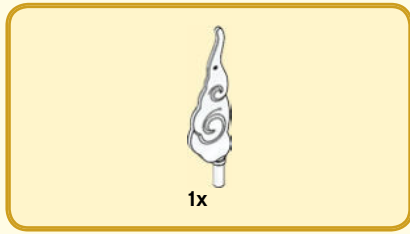
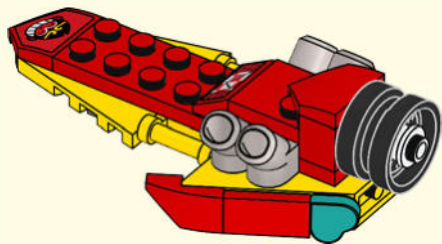

17

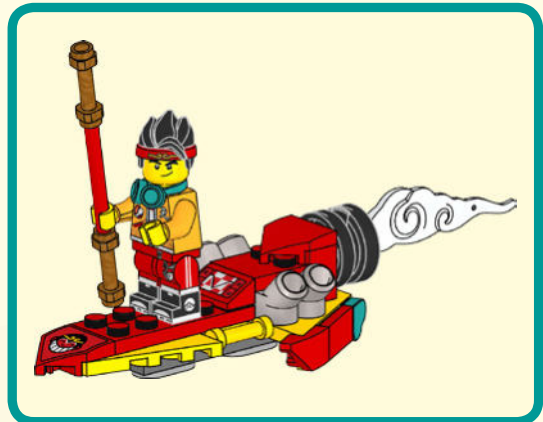

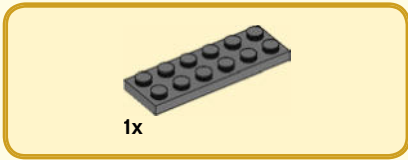
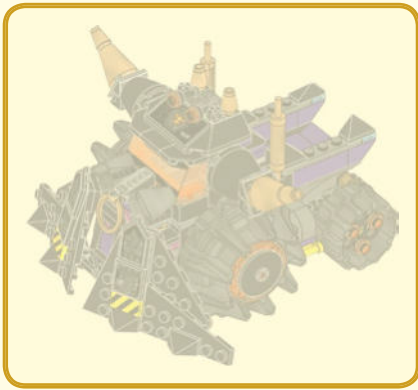

1

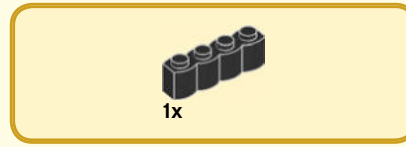
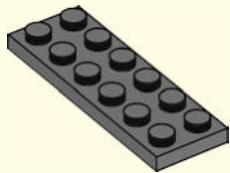

2

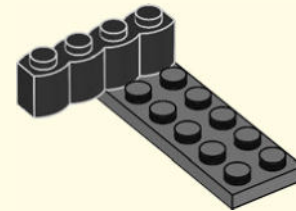

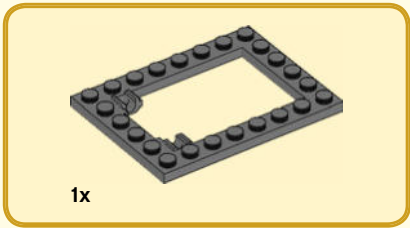

3

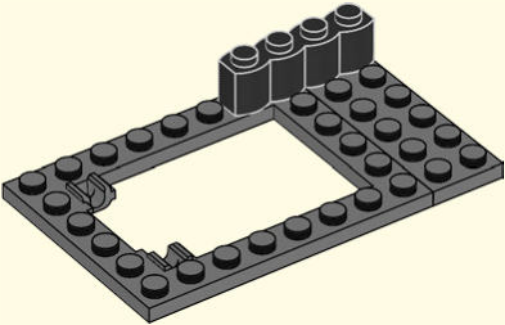

4

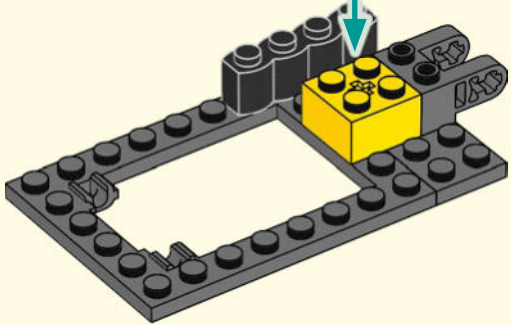
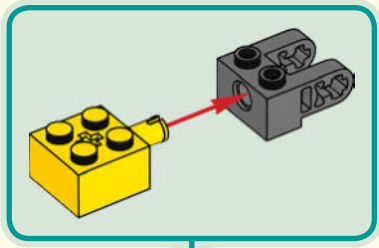



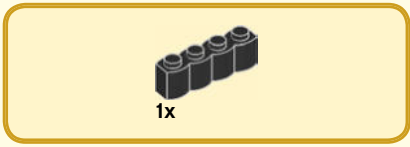

5

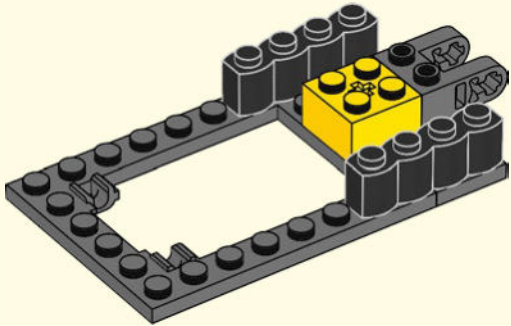

6

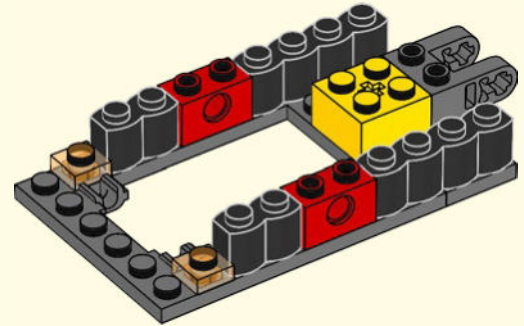

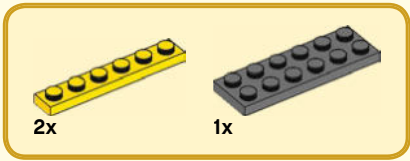

7

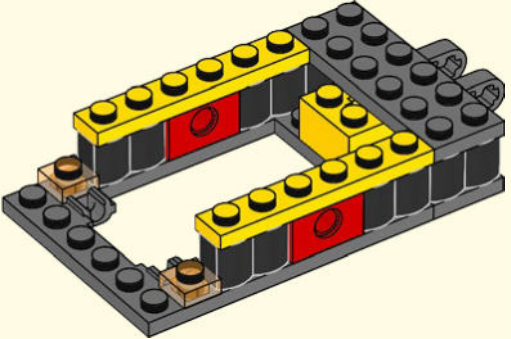

8

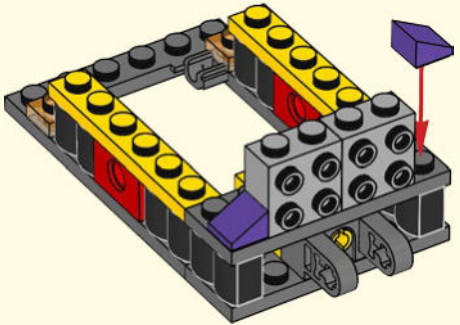



9

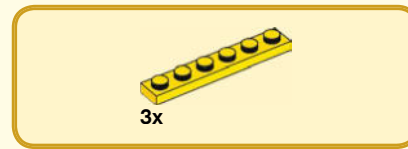
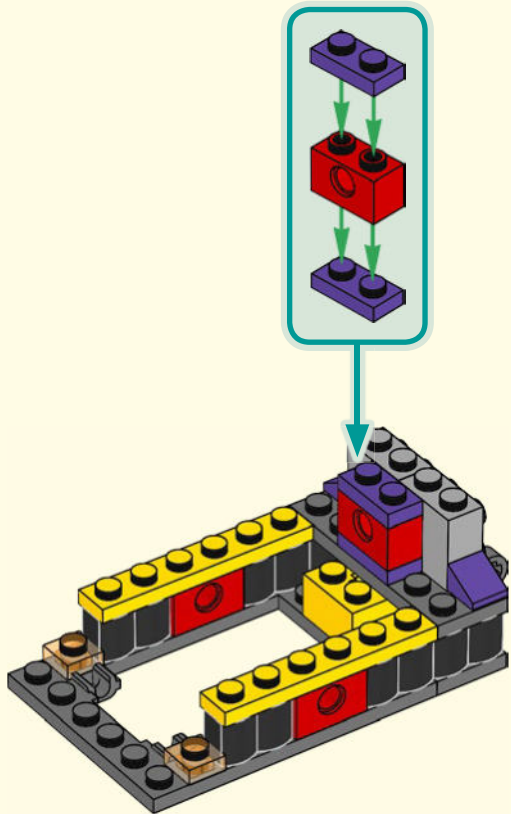

10

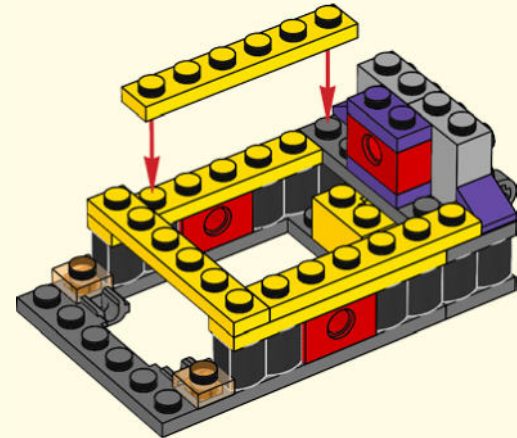

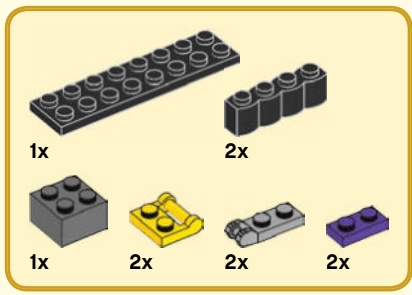

# 11

1

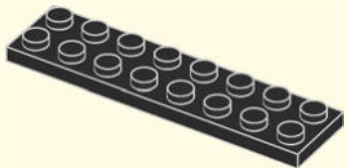

2

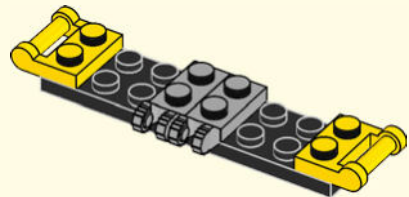

3

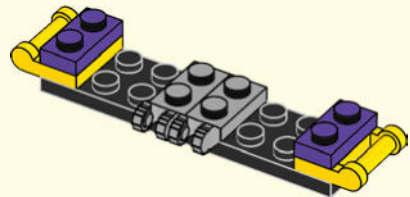

4

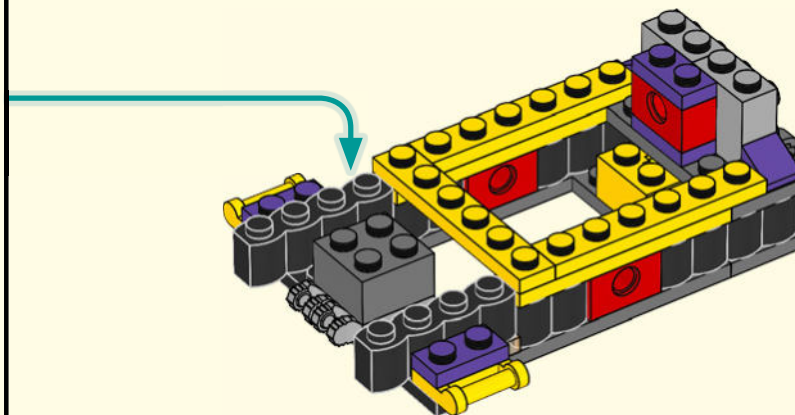
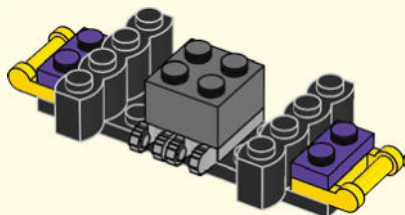

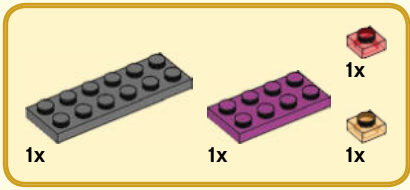

# 12

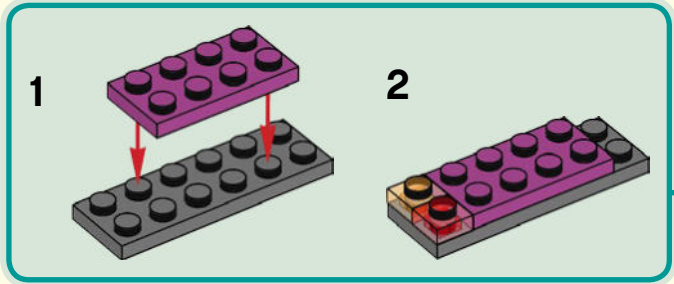
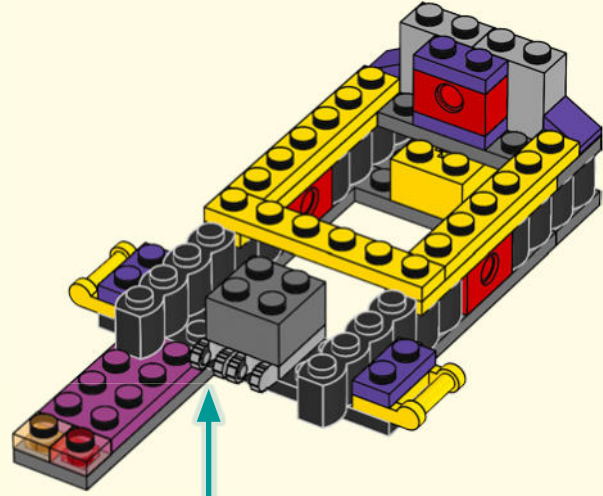

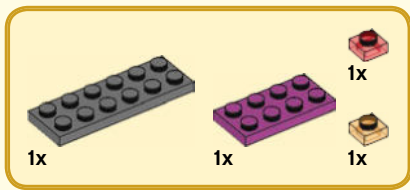

13

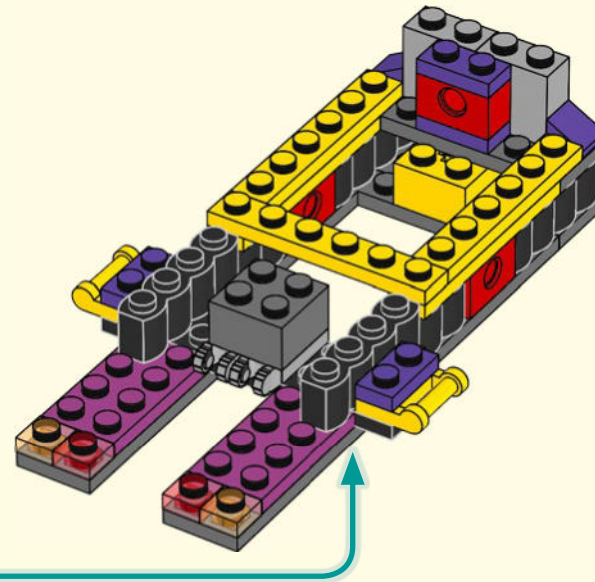
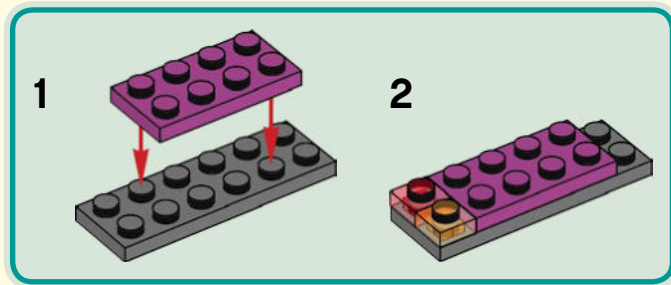



2x

14

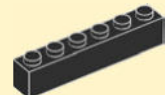
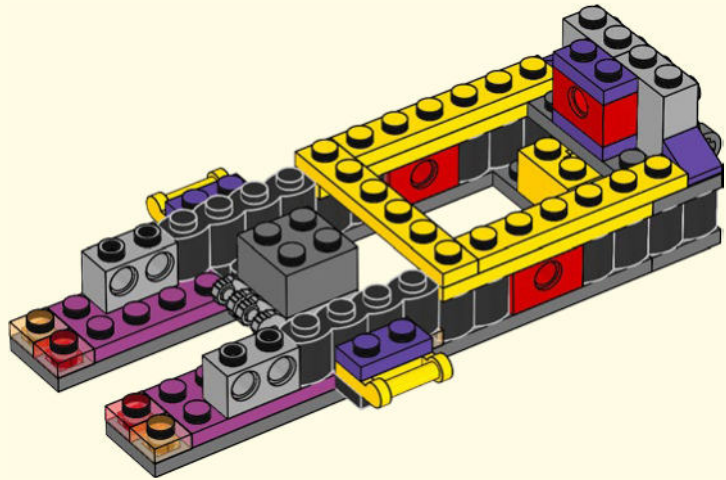

2x



2x

15

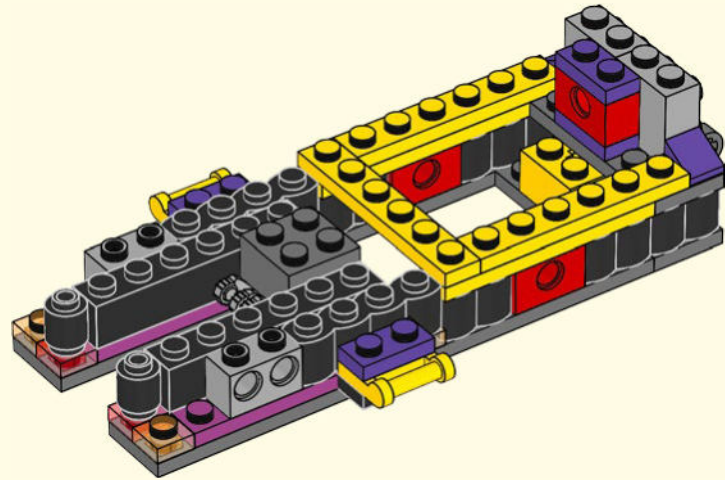





16

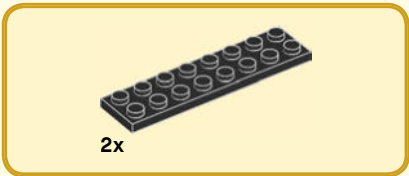
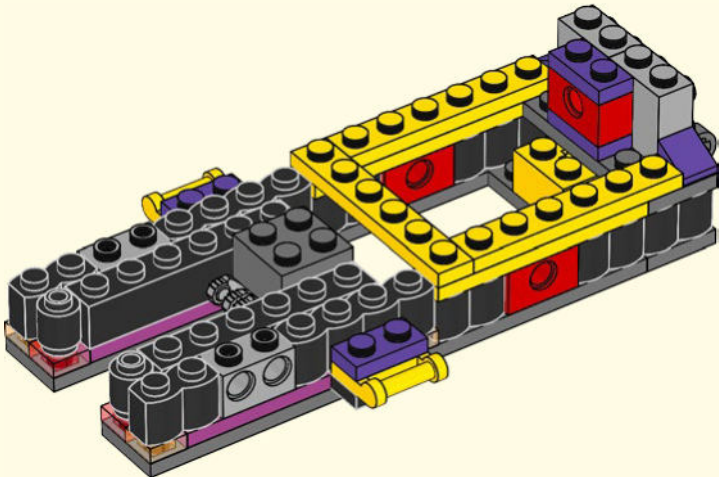

17

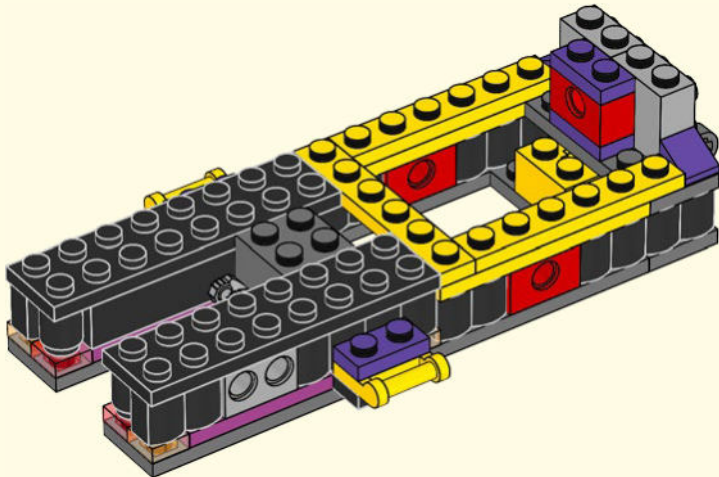



4x

18

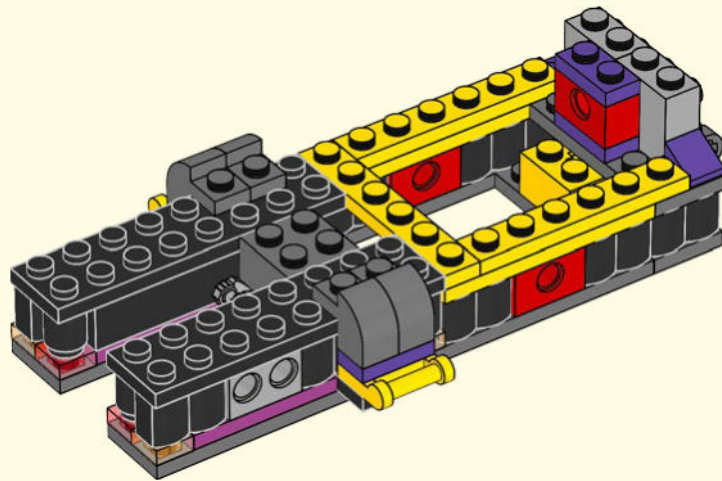



19

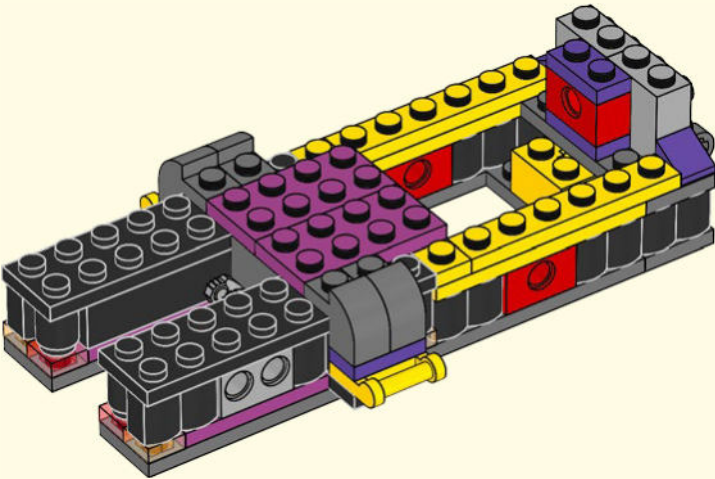

20

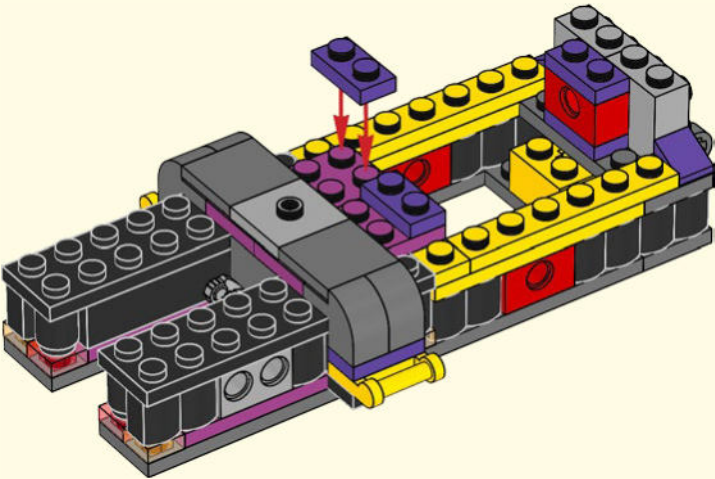

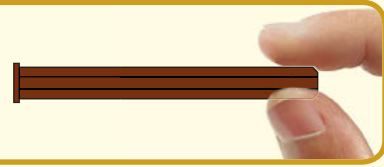
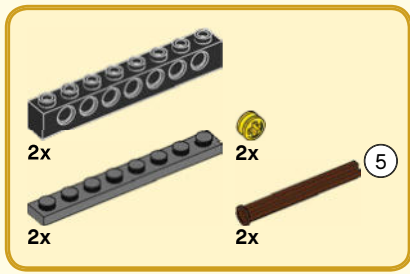

21

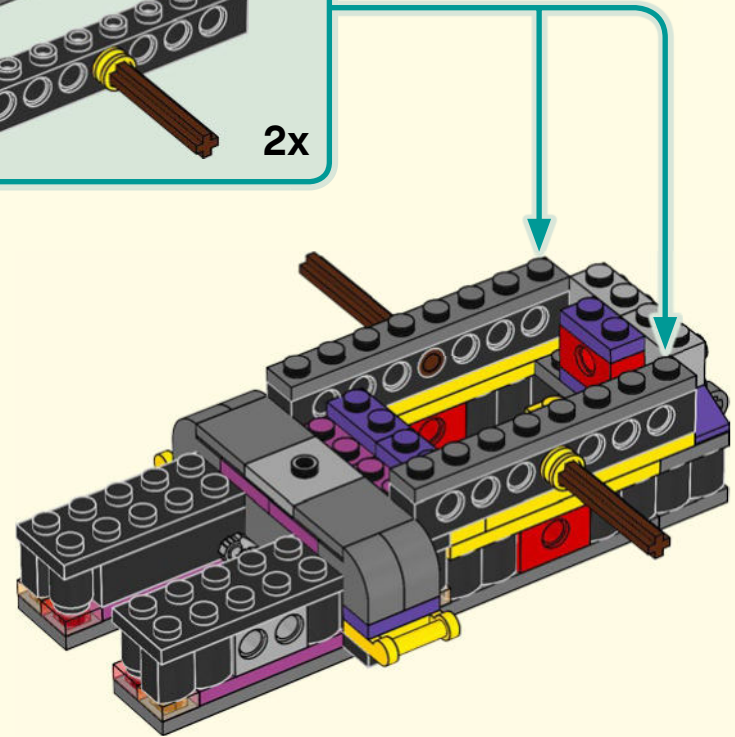
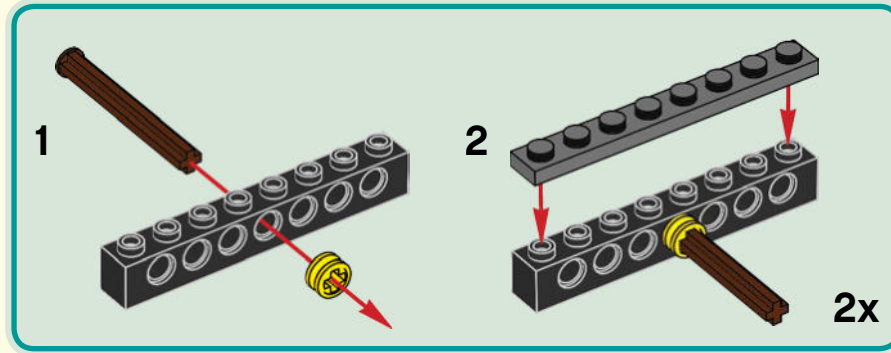

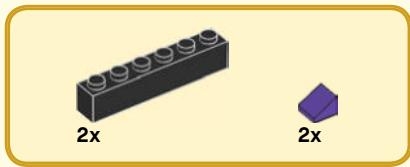

22

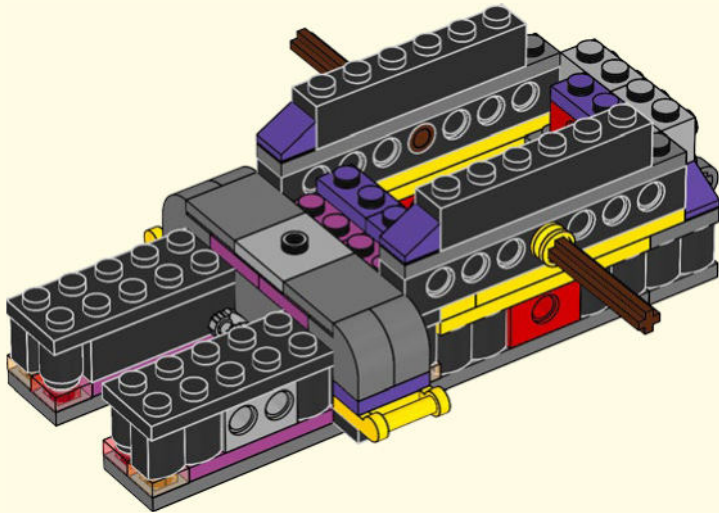

23

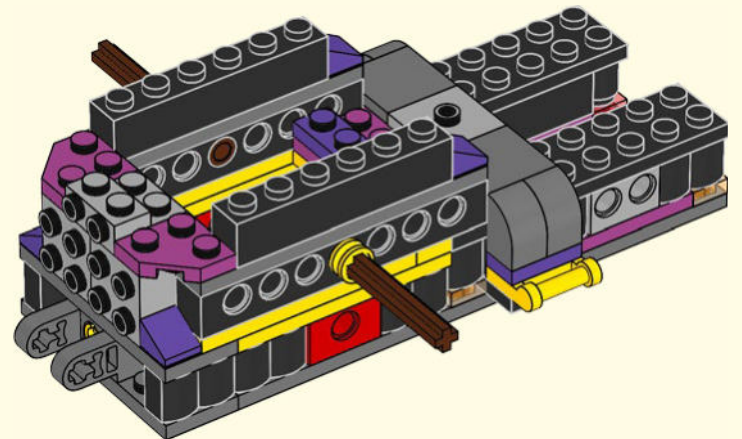



1x



2x

24

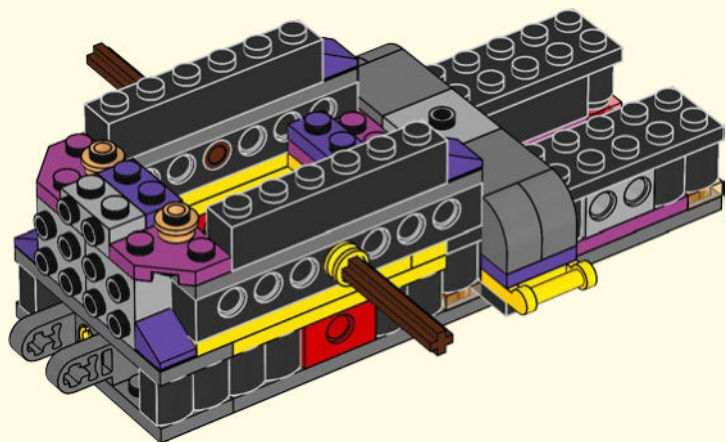

2x

25

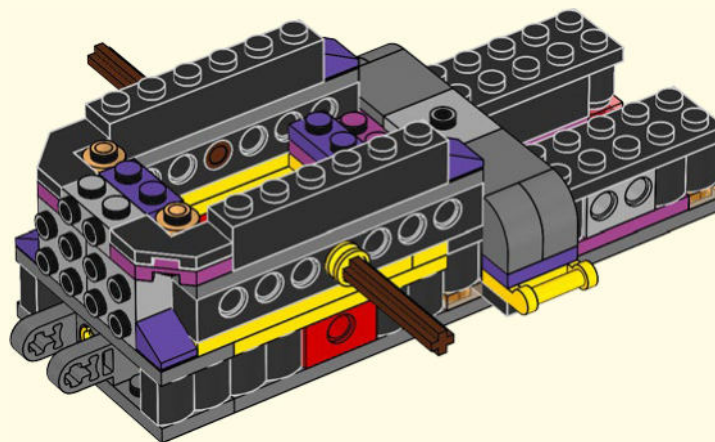

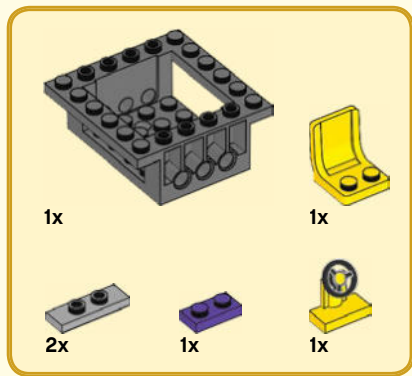

26

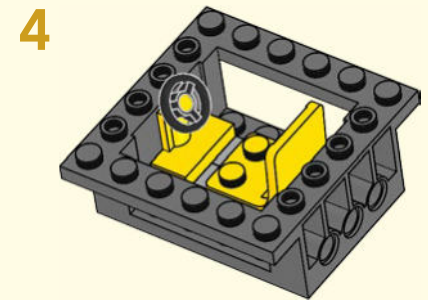
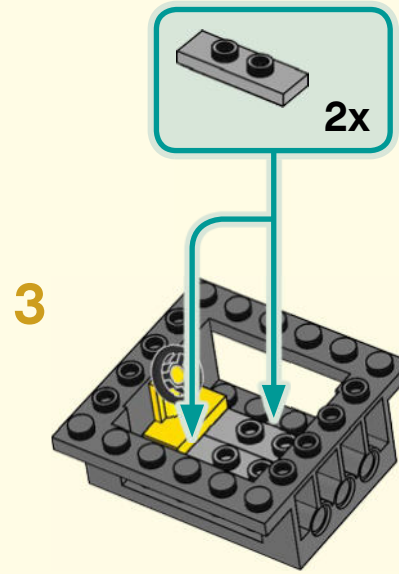
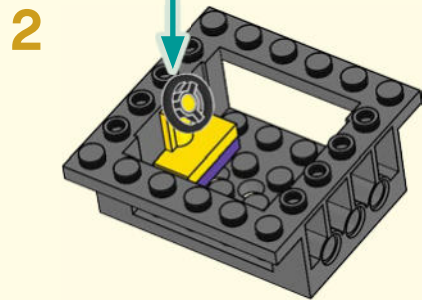
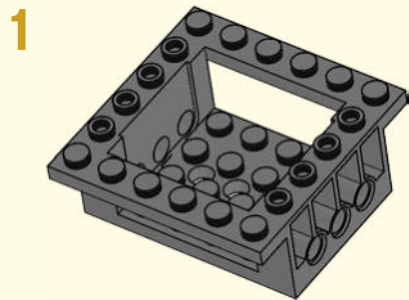
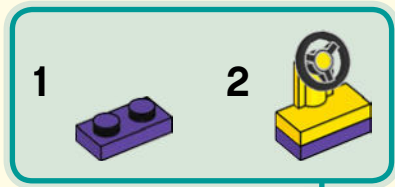

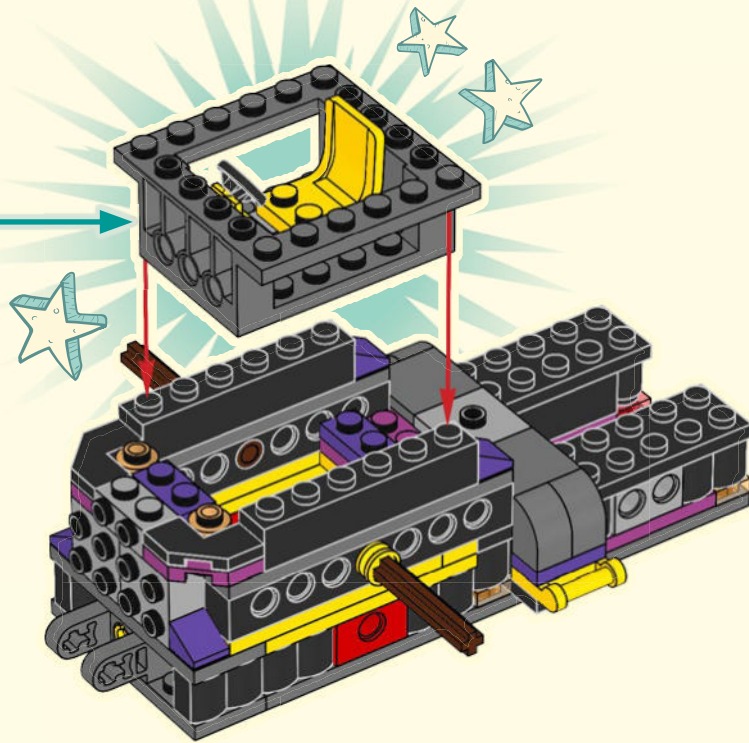



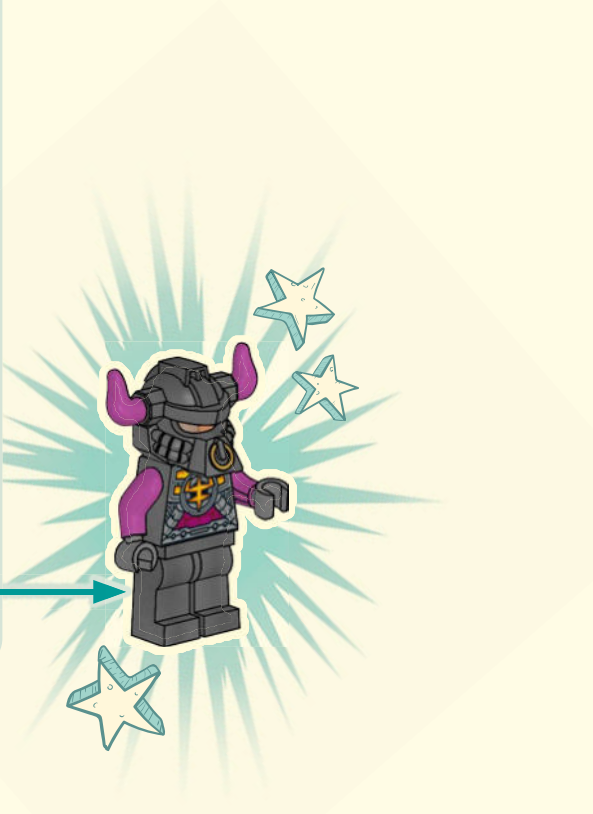
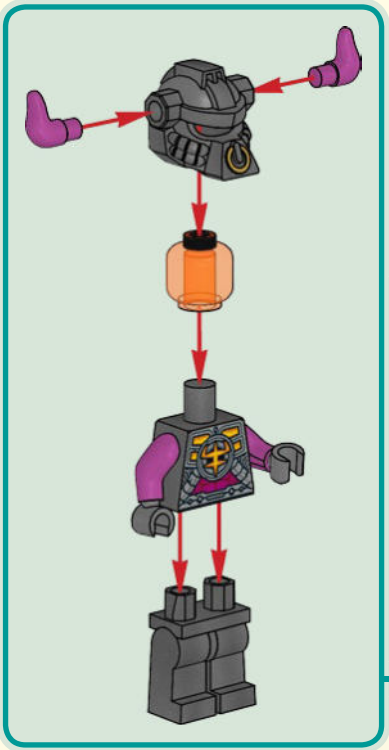



2x



2x

27

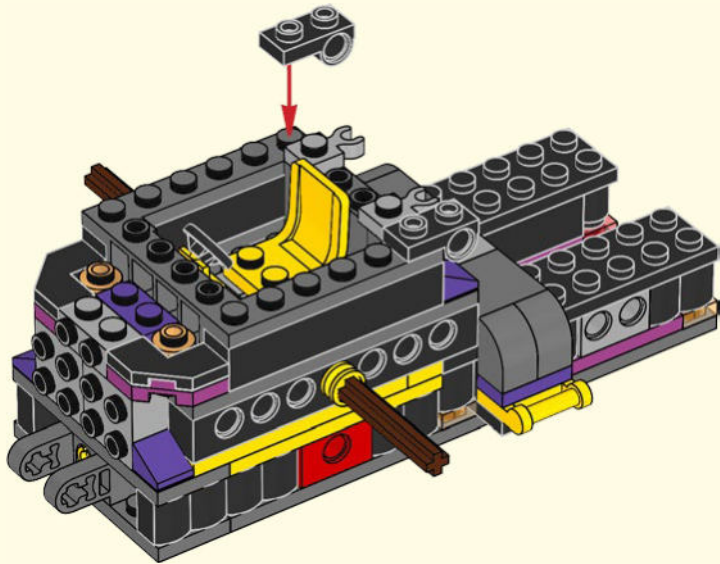

2x



2x

28

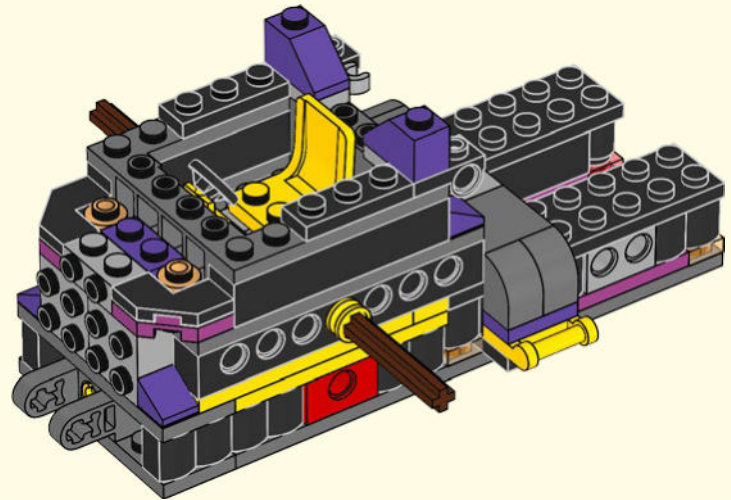



29

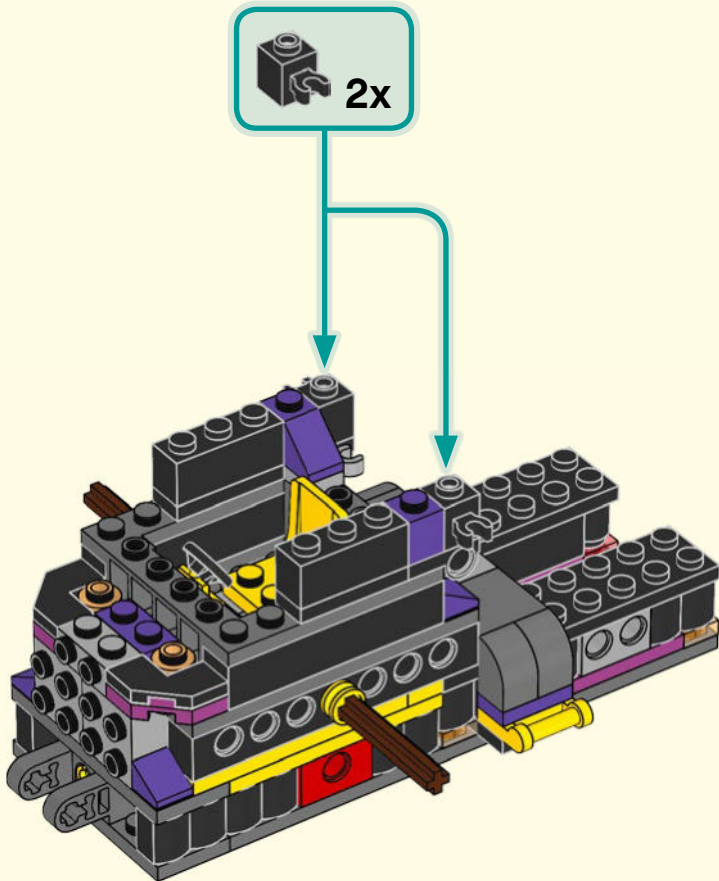

30

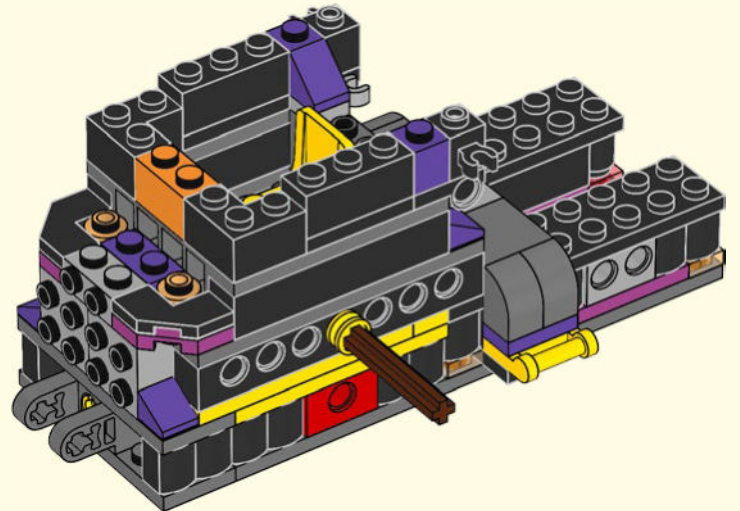



4x

31

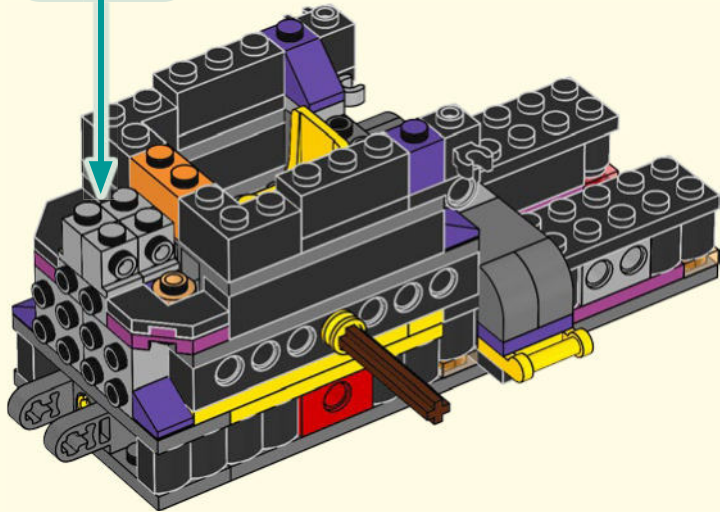
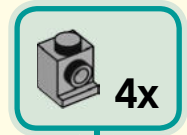

2x

32

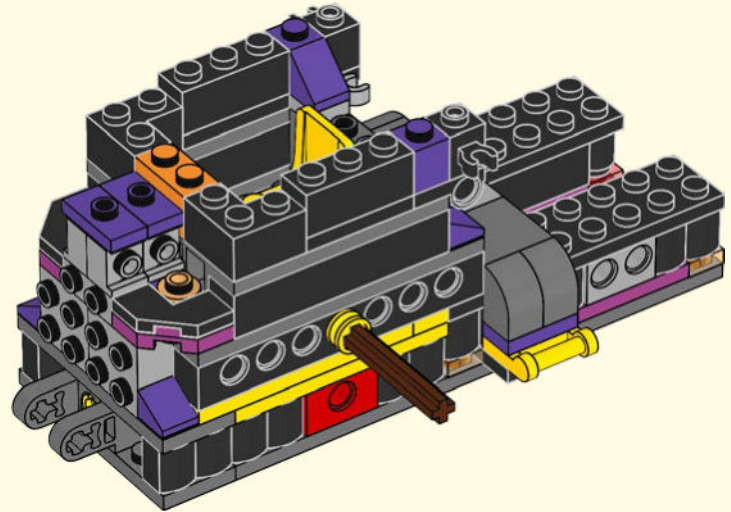



33

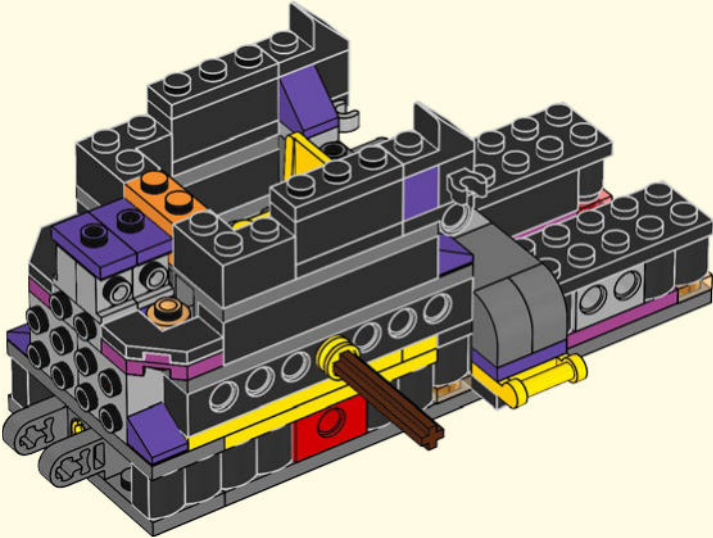

34

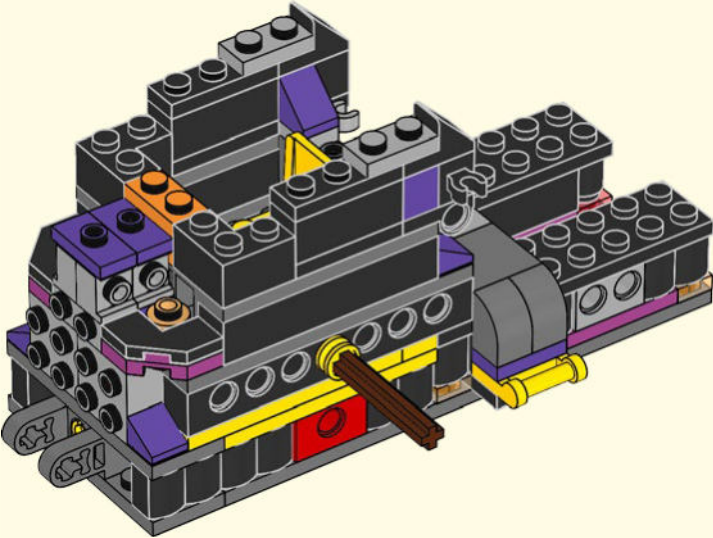



# 35

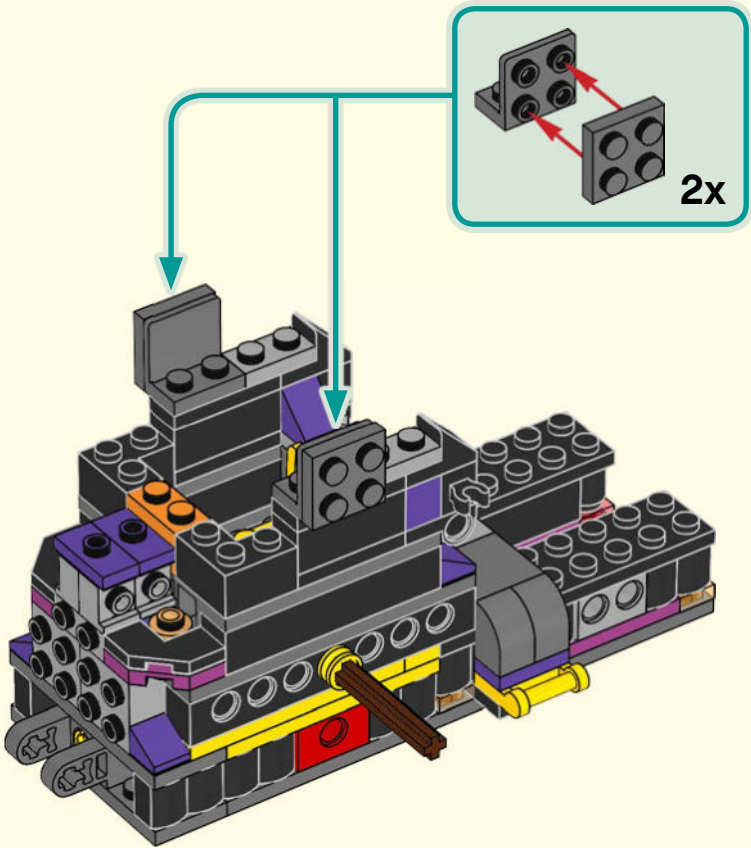

# 36

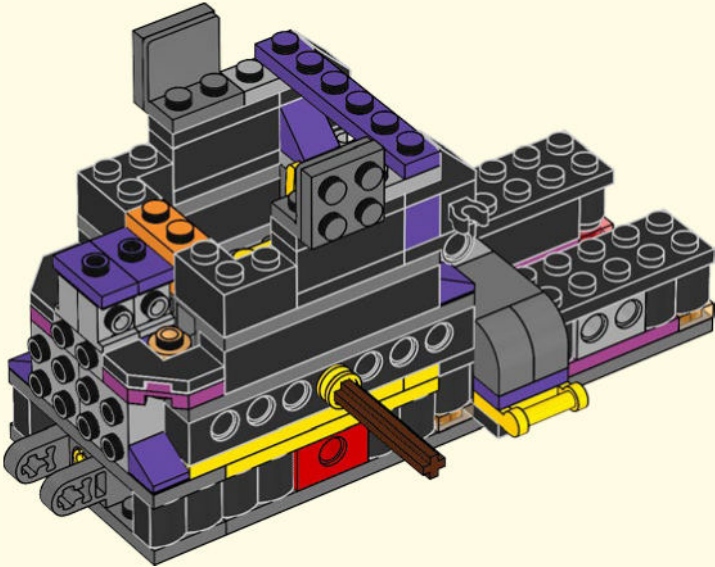

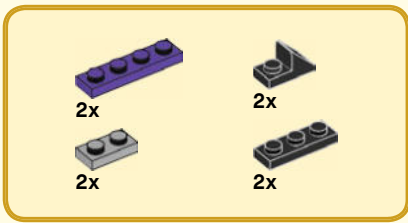

37

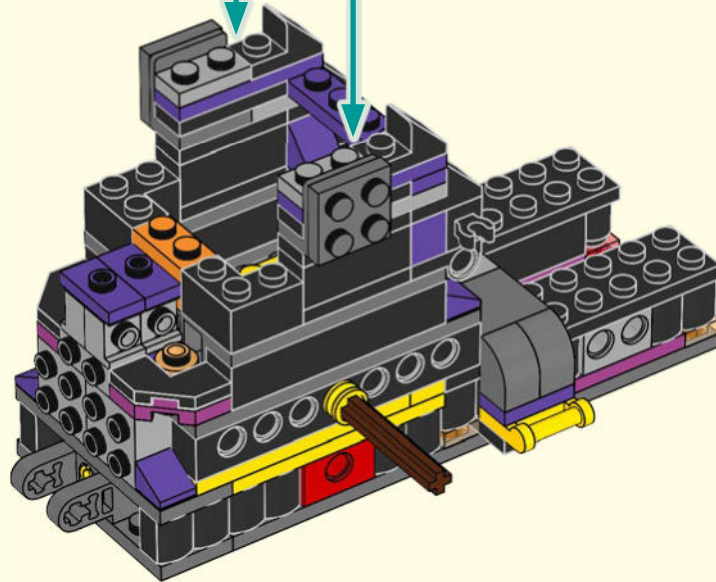
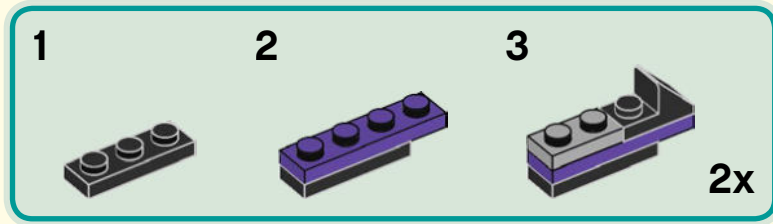

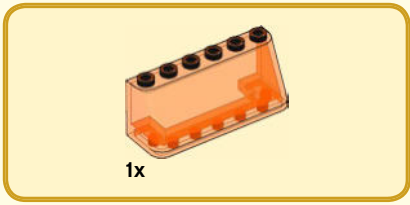

# 38

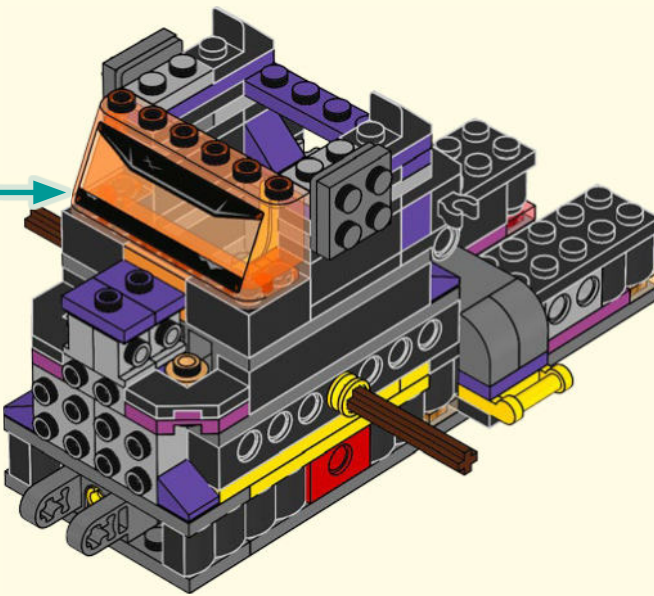
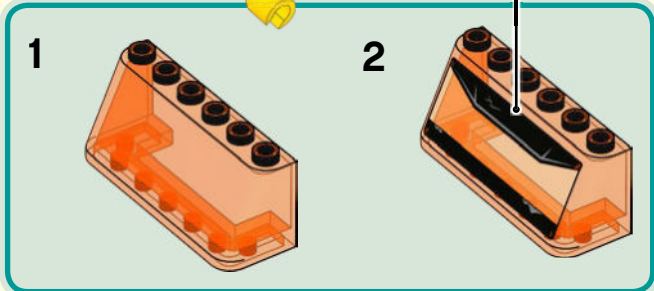





39

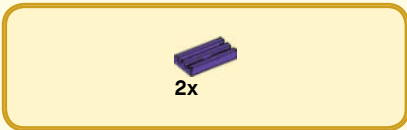
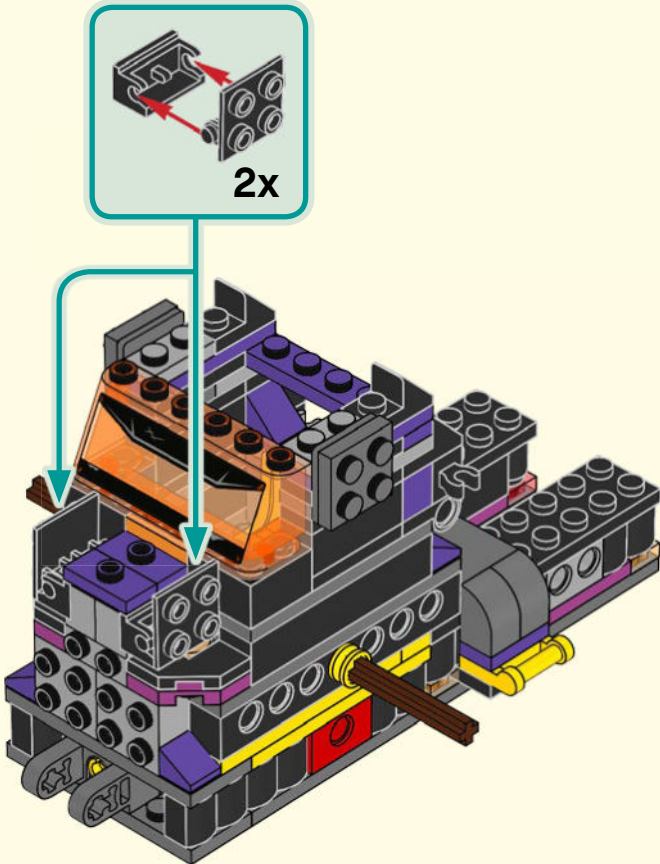

40

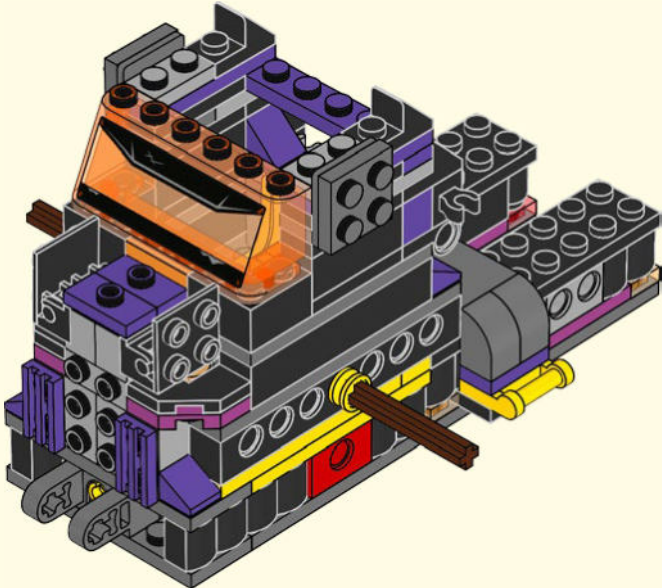

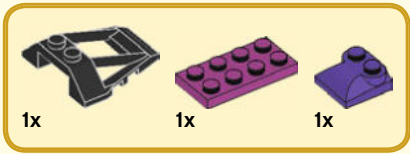

41

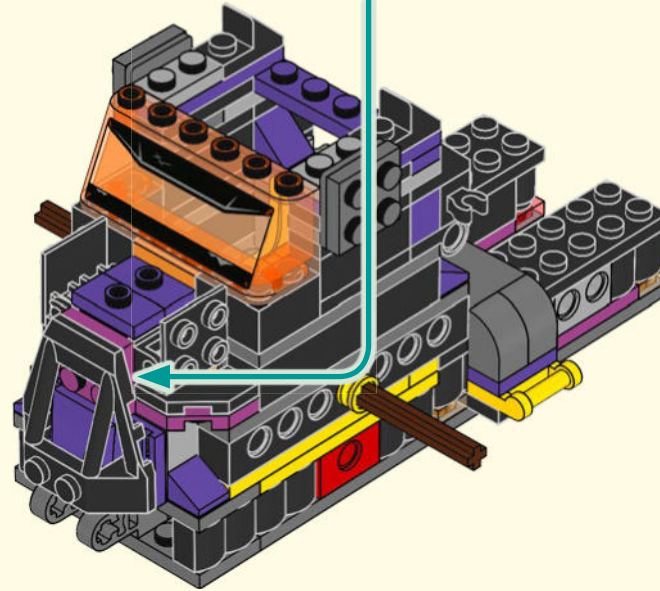
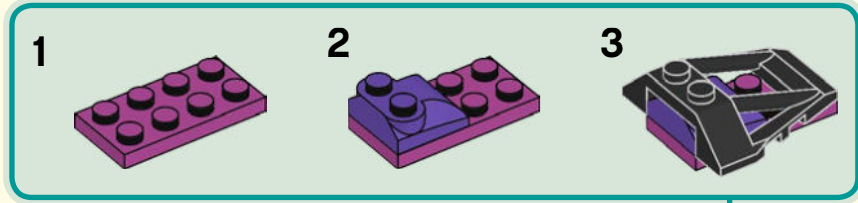



42

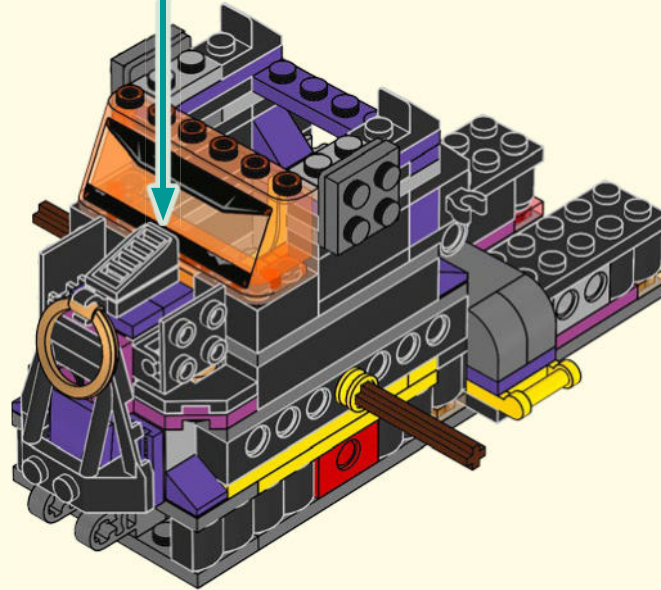
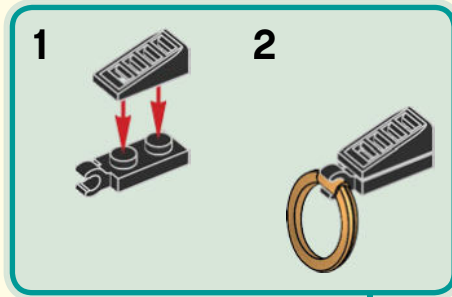



2x

43

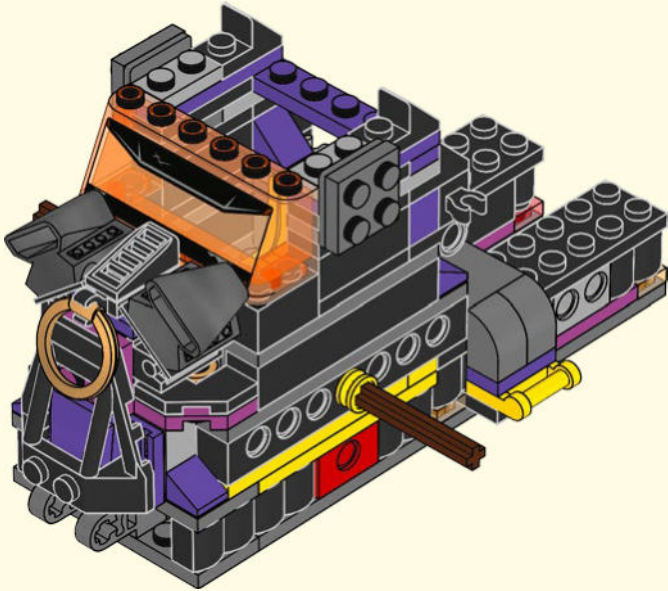

2x

44

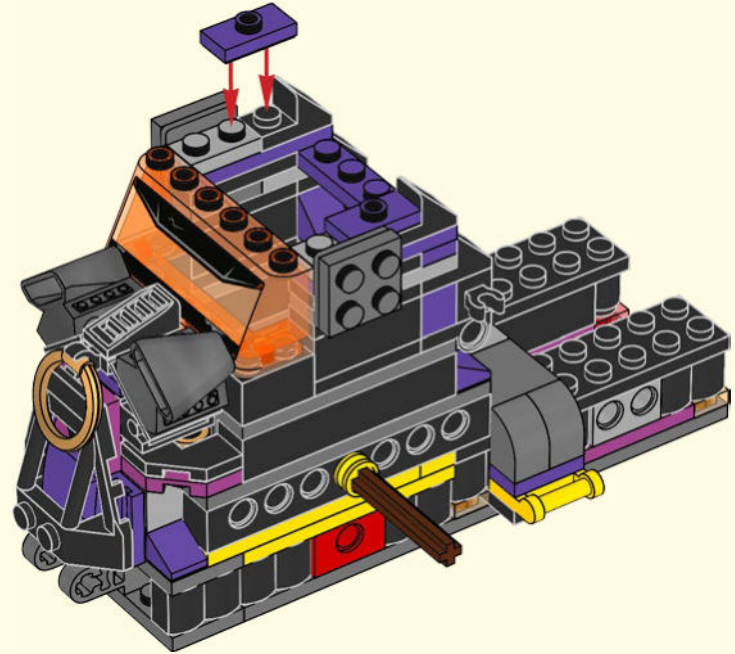



45

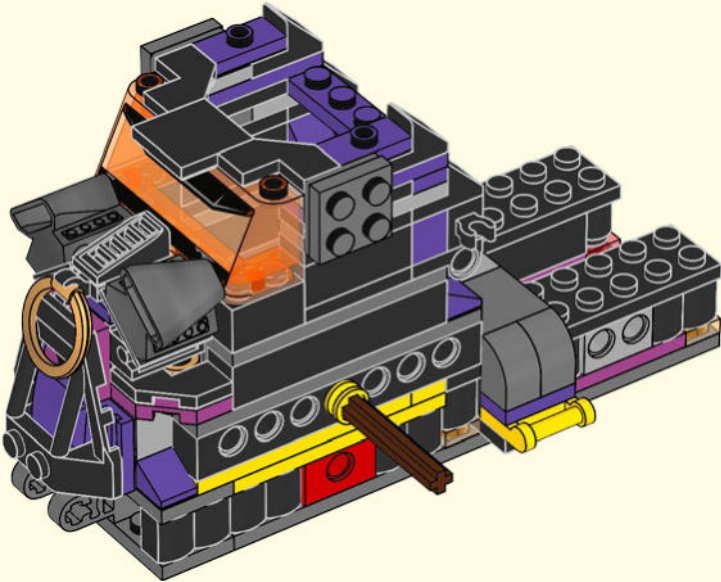

46

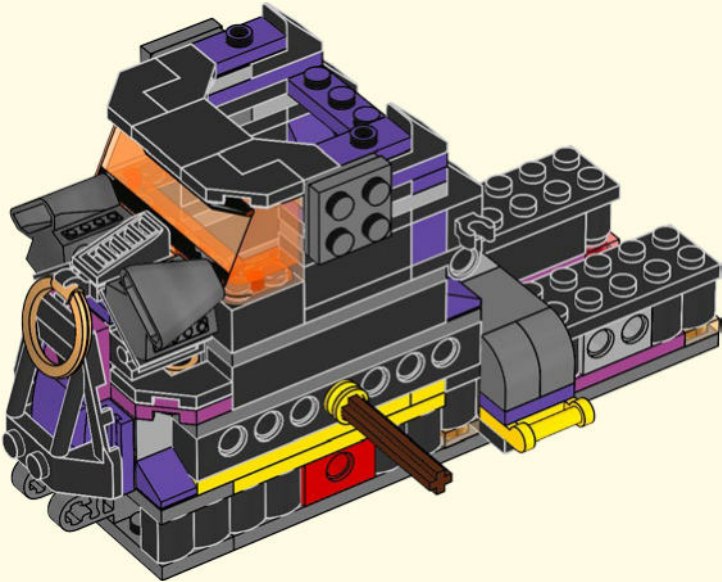

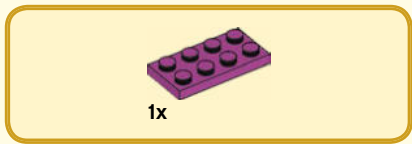

47

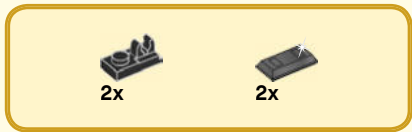
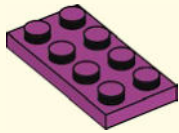

48

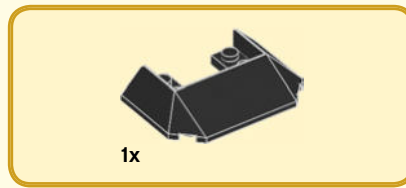

49

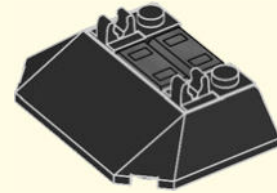

50

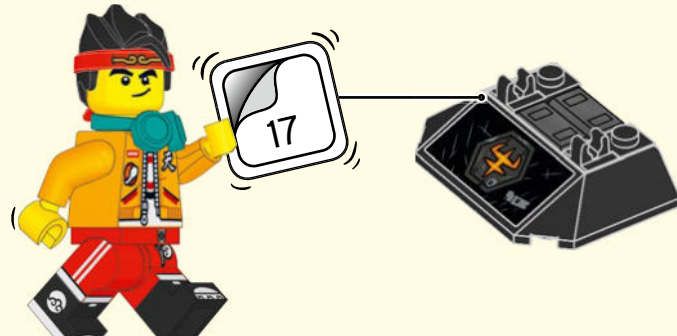



51

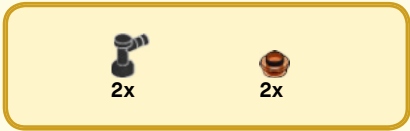

52

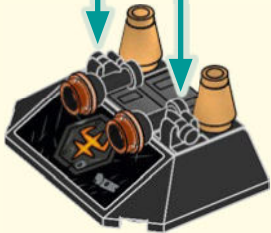

53

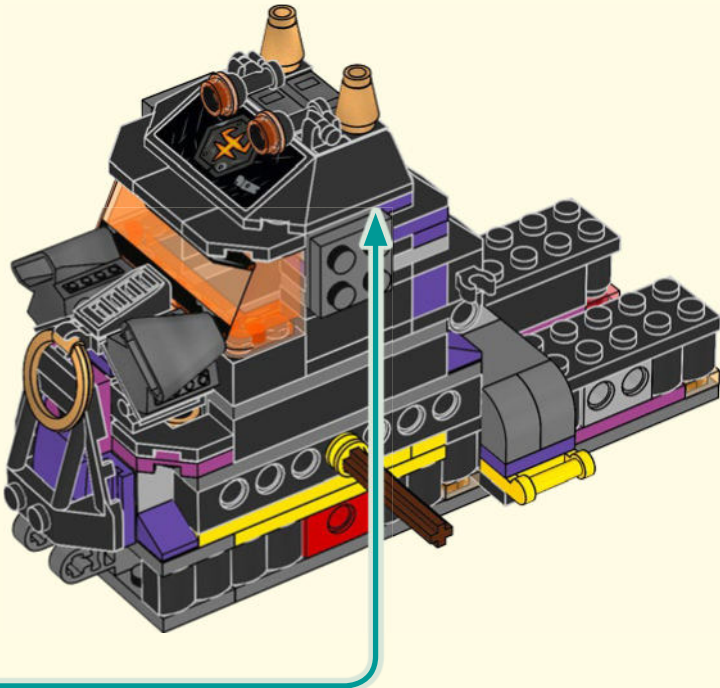

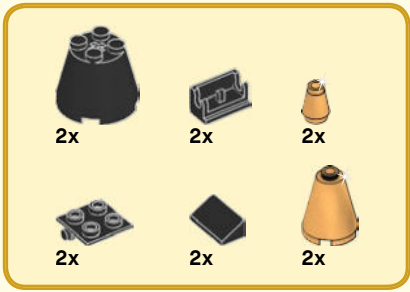

54

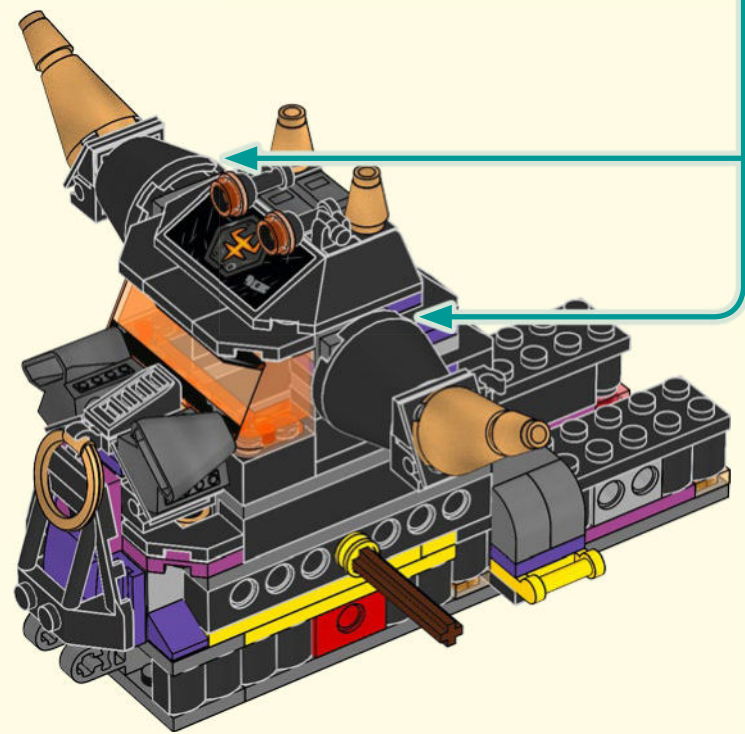
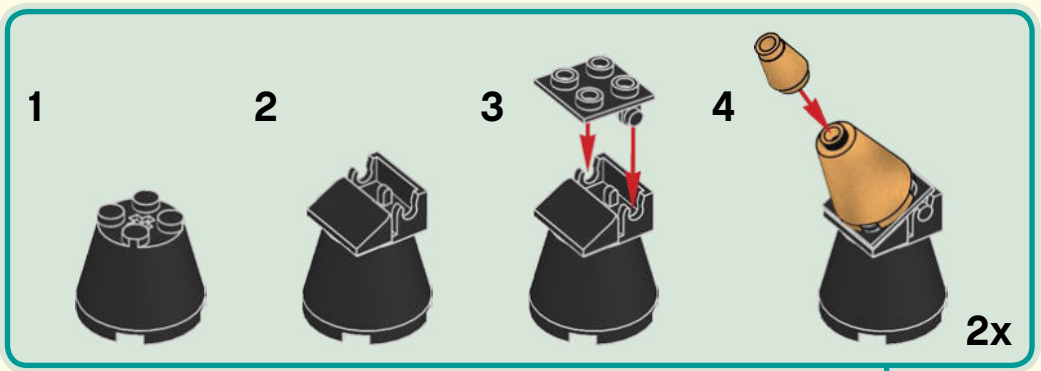





55

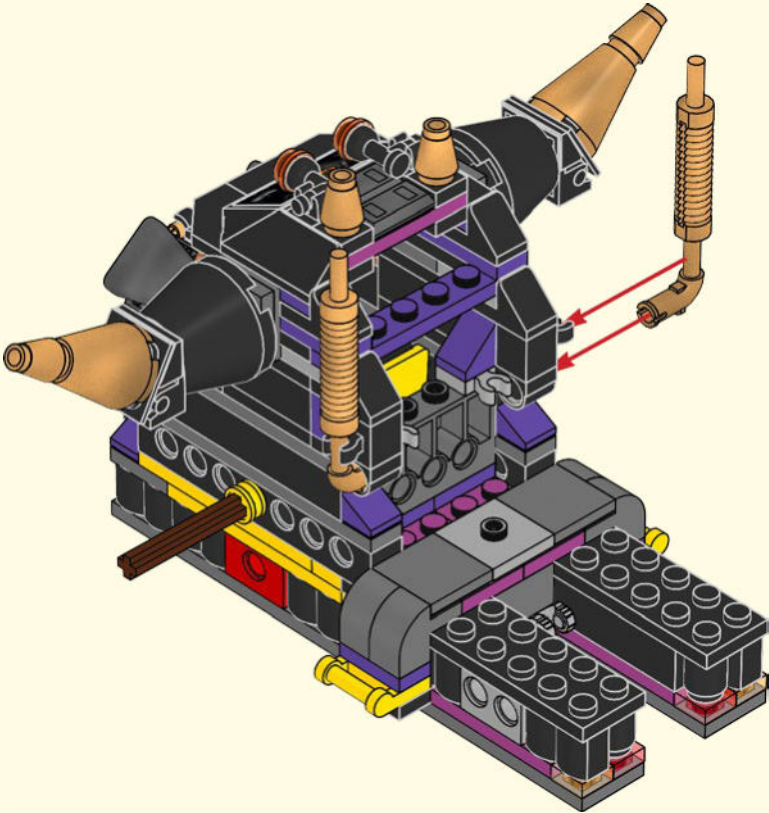



56

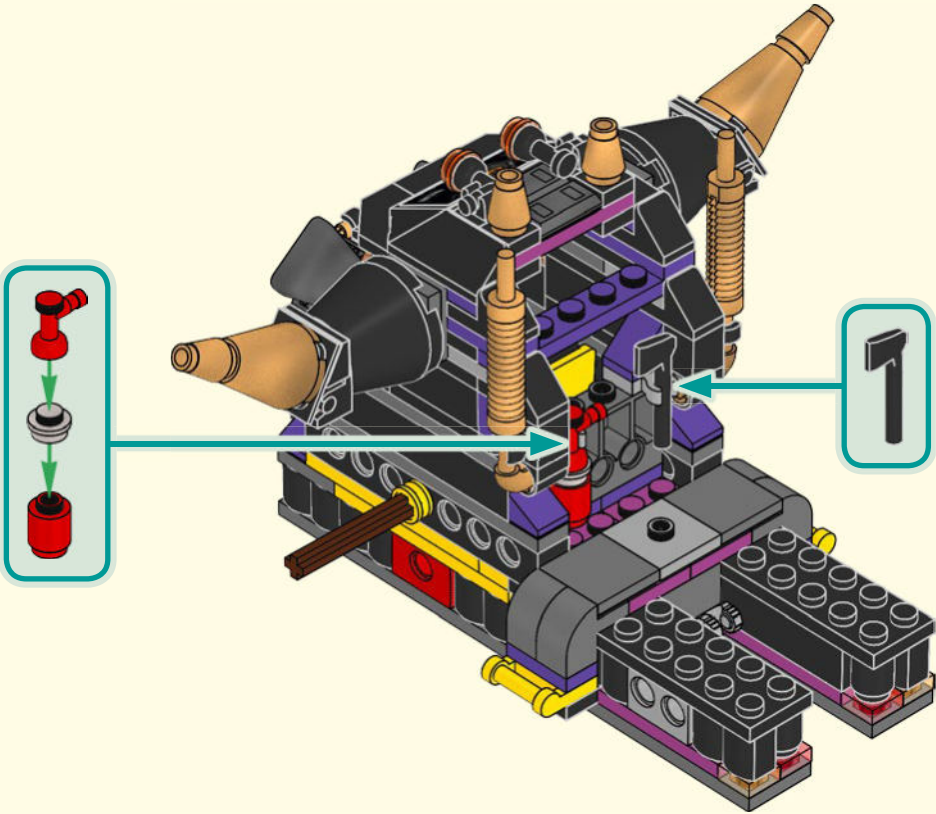



57

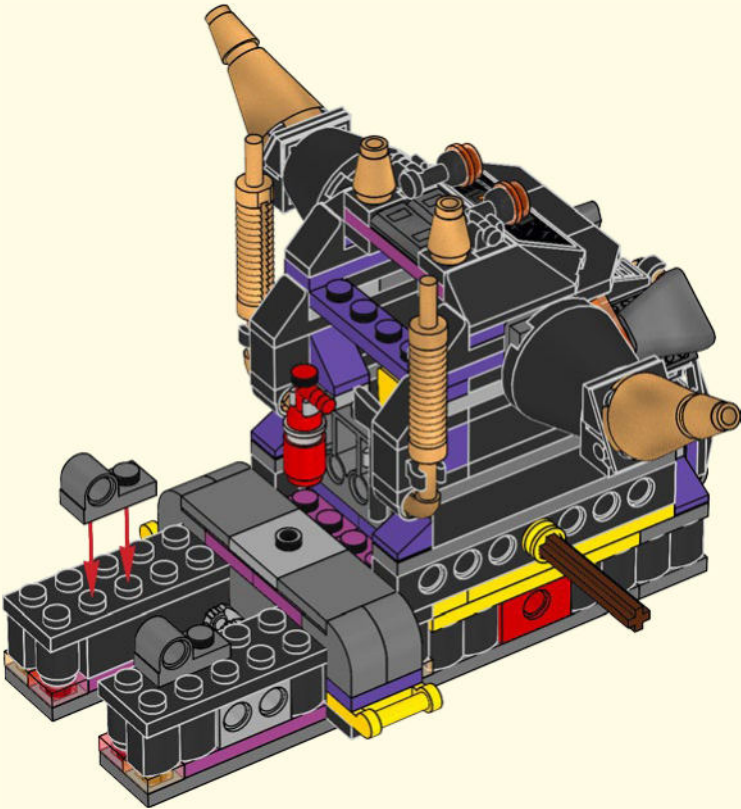



2x

58

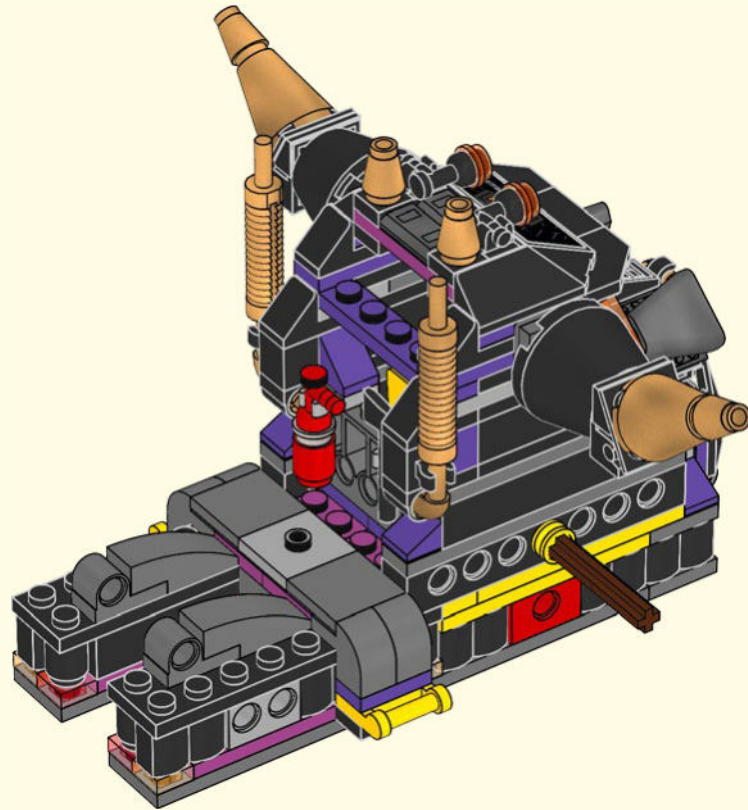



59

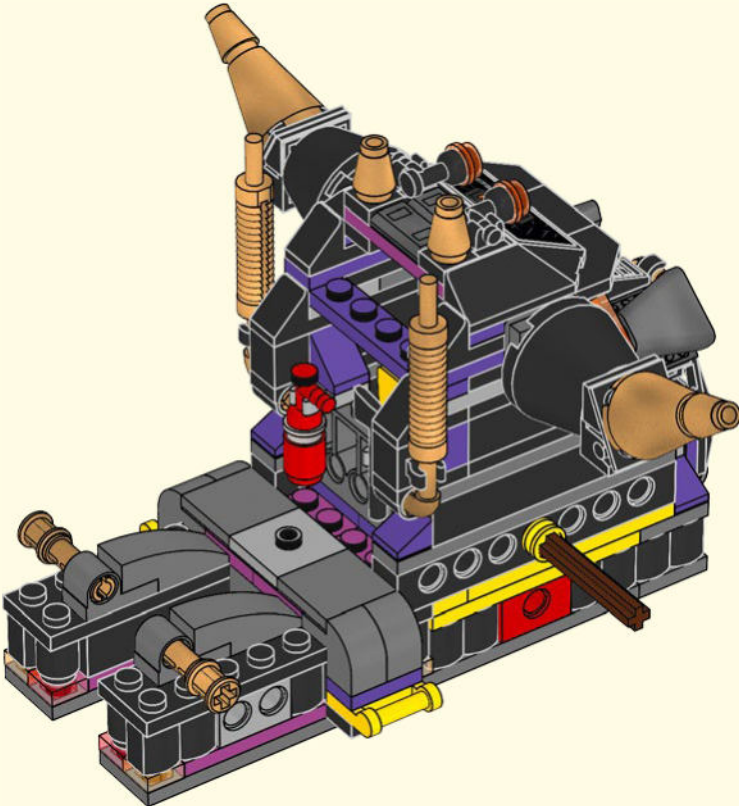

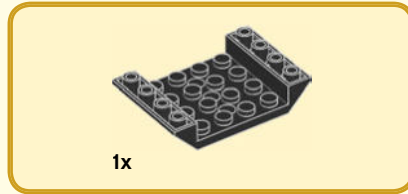

60

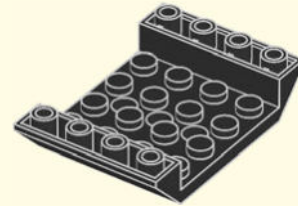

61

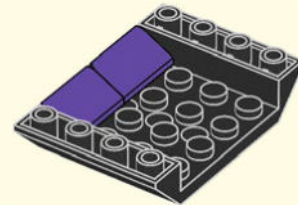



62

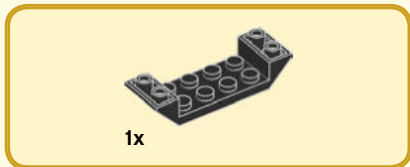
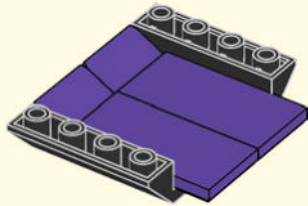

63

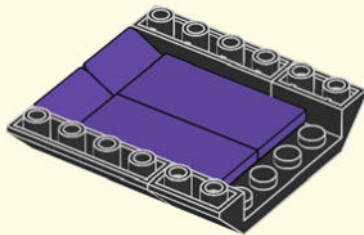

64

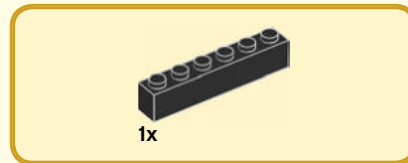
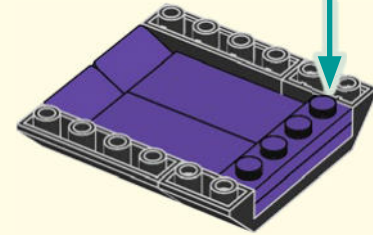
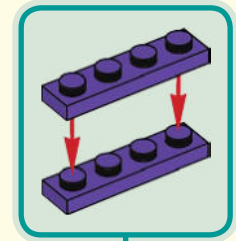

65

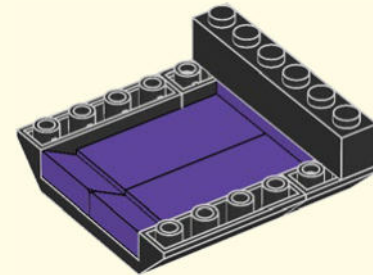

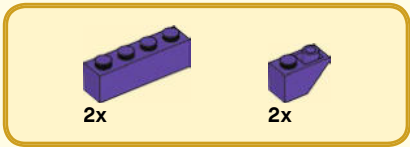

66

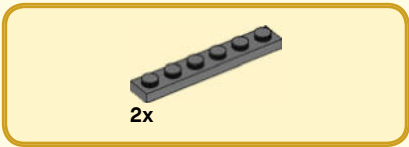
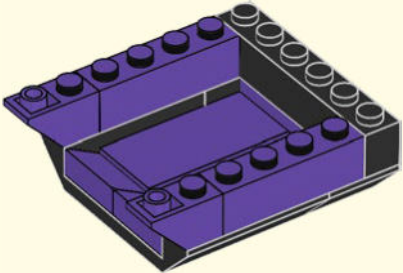

67

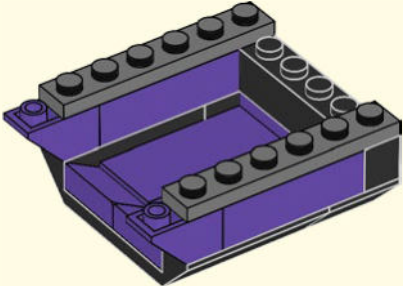

68

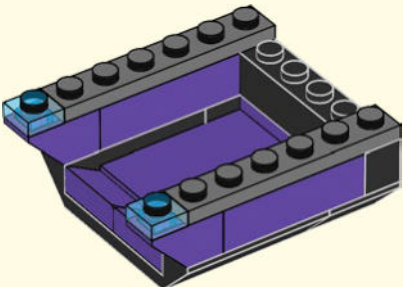





69

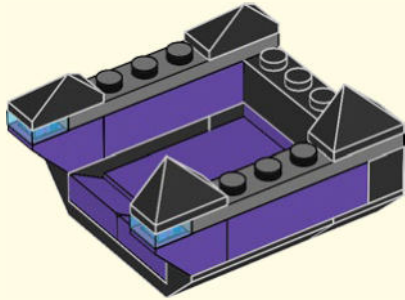

70

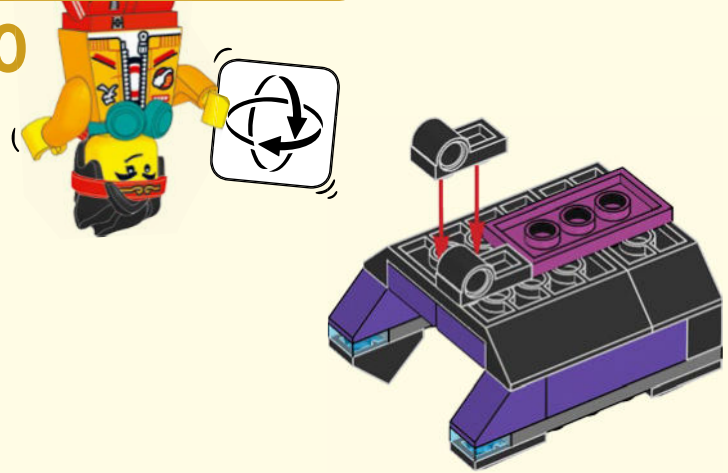

71

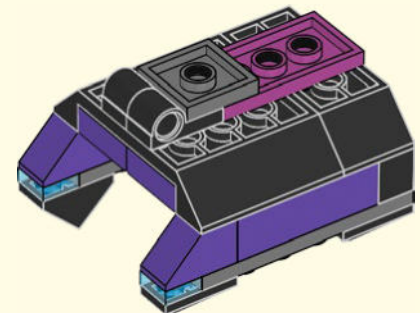

72

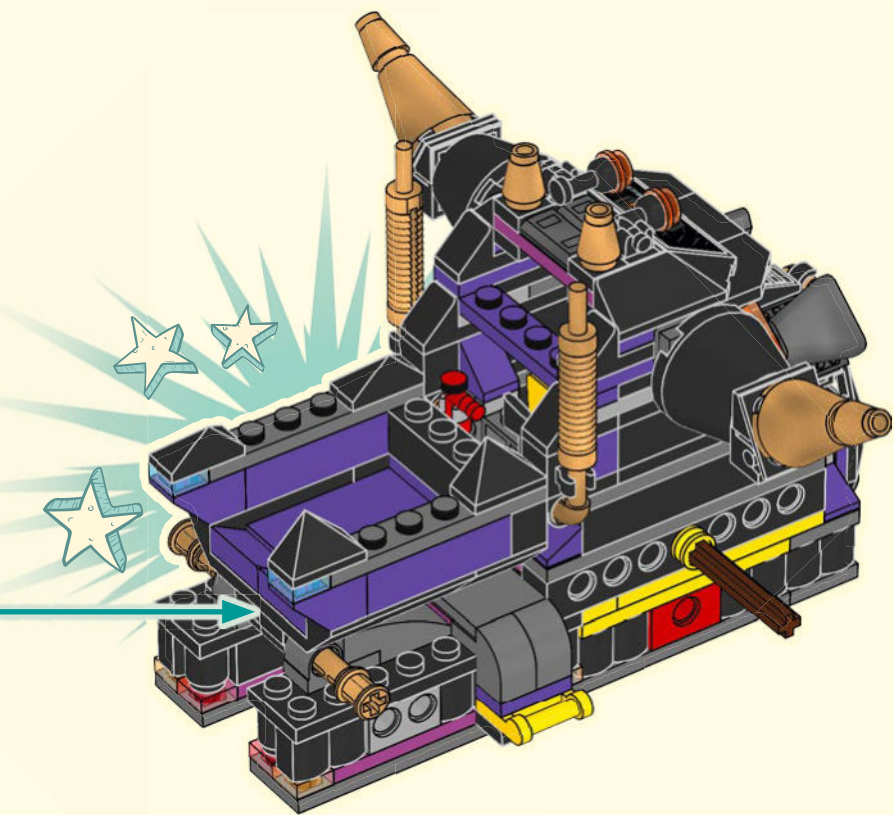

73

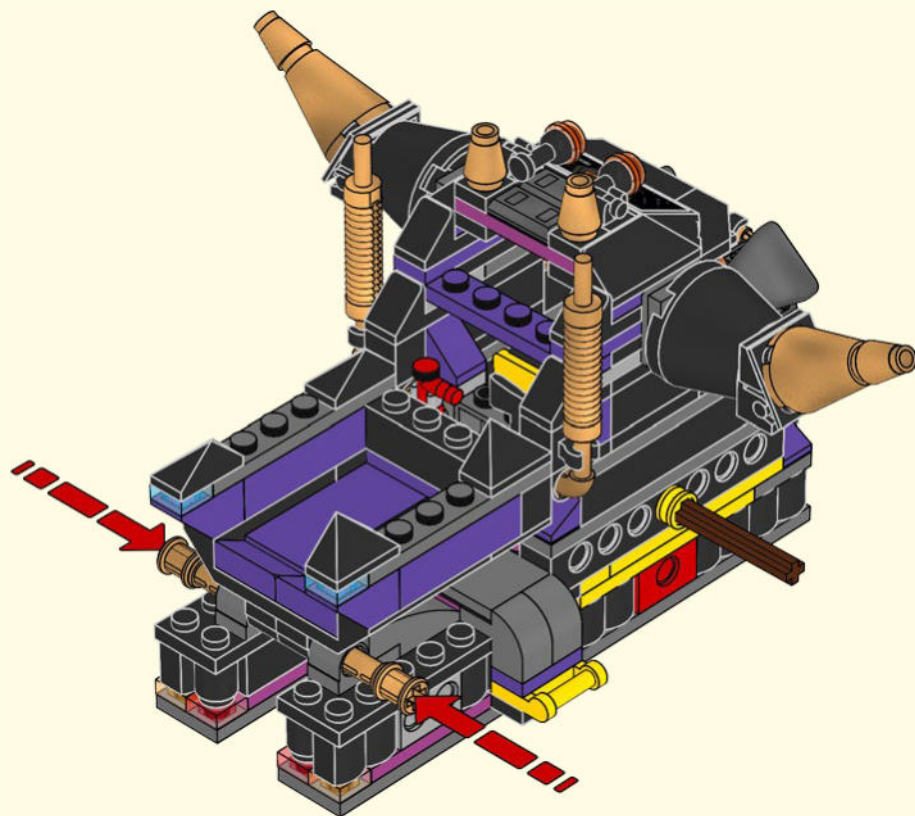

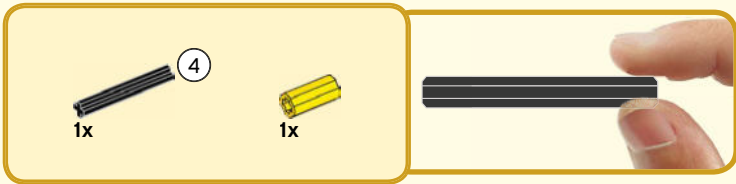

74

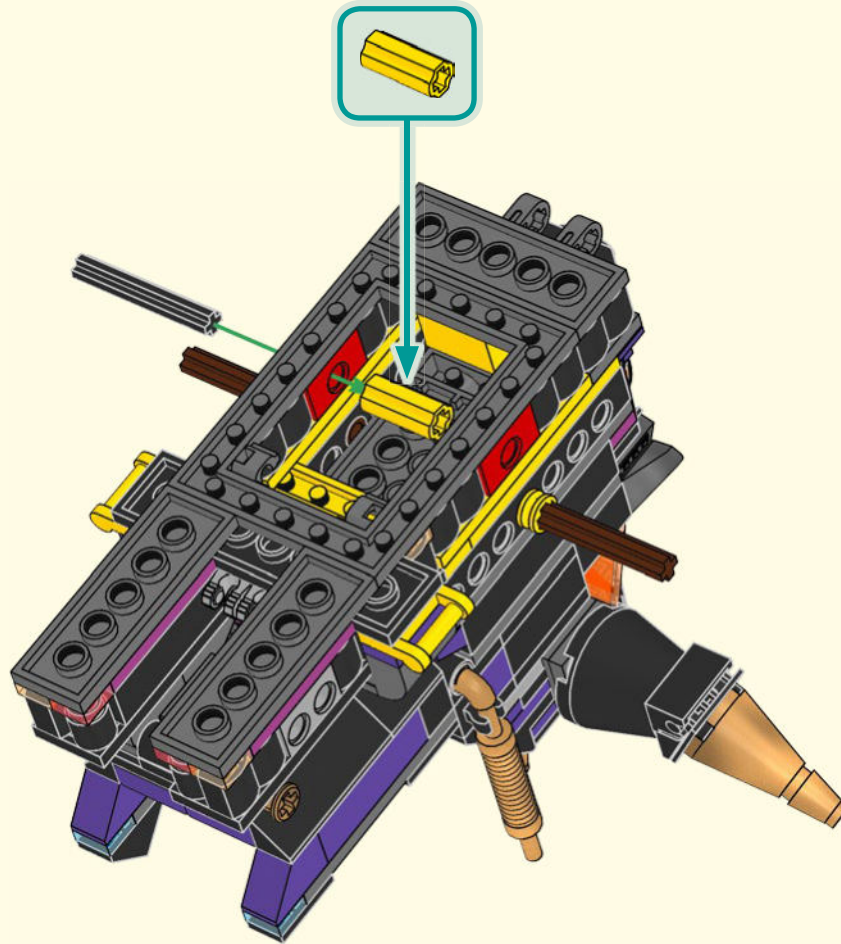



1x

75

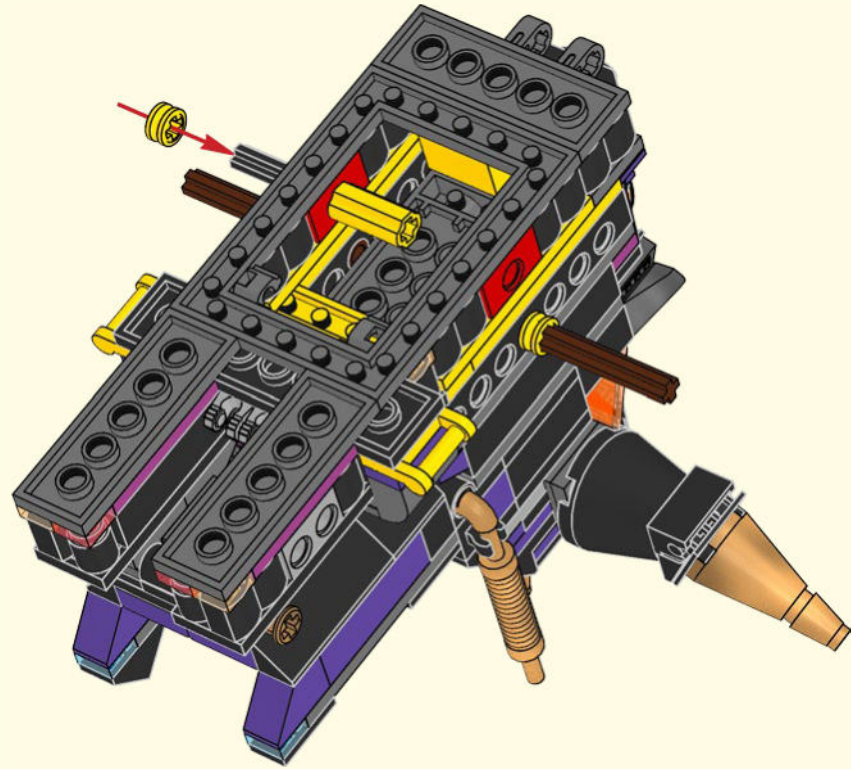

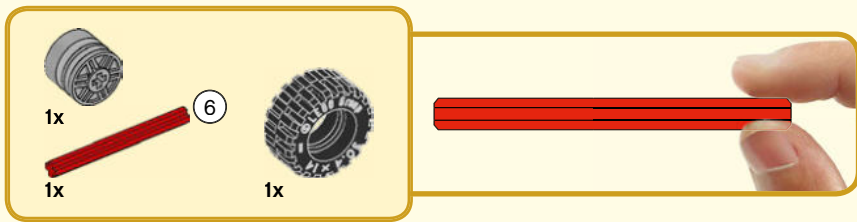

76

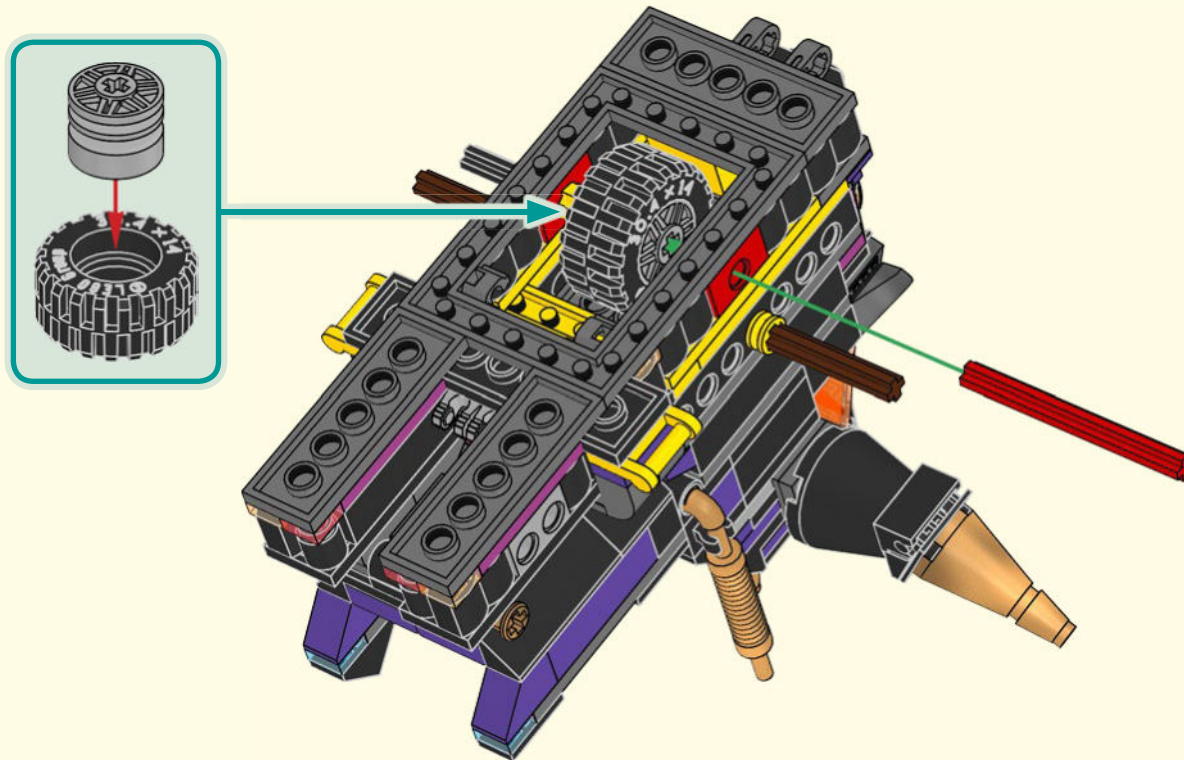



1x

77

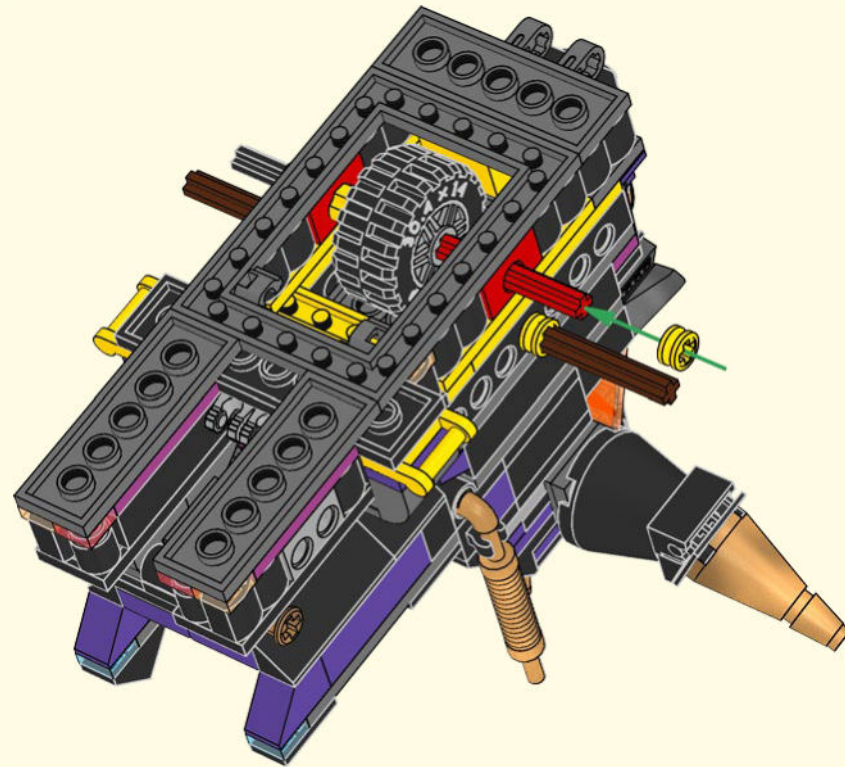



78

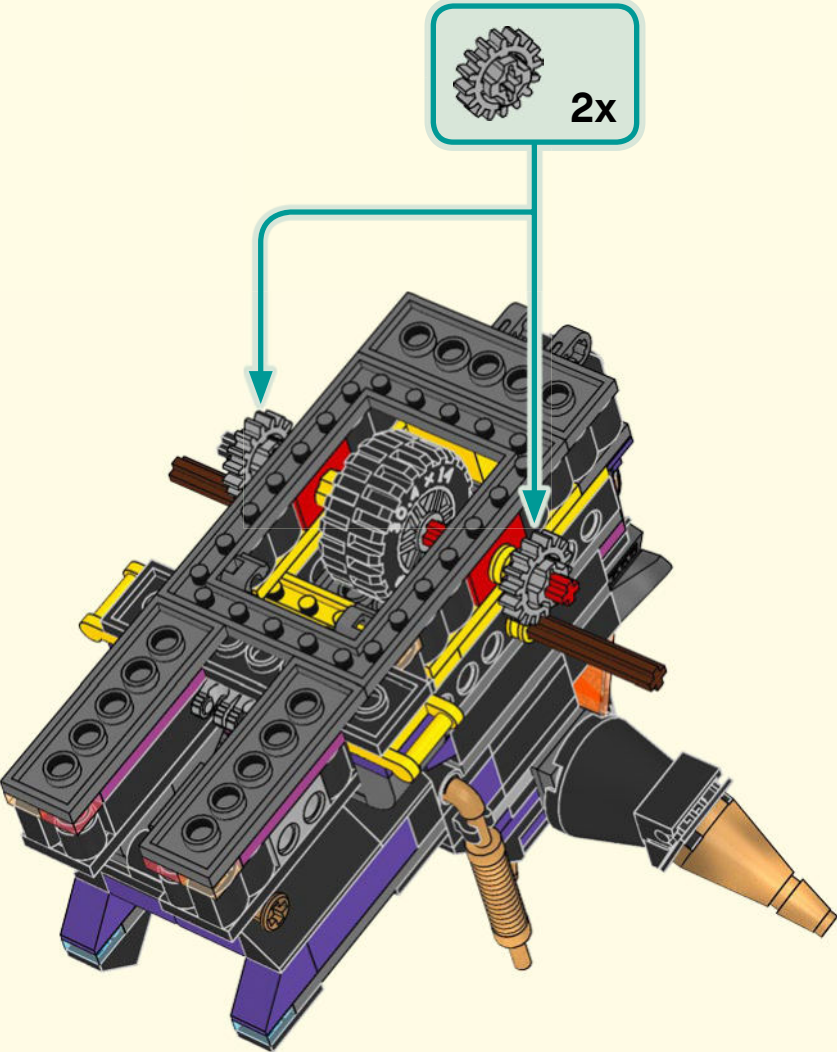



1x

79

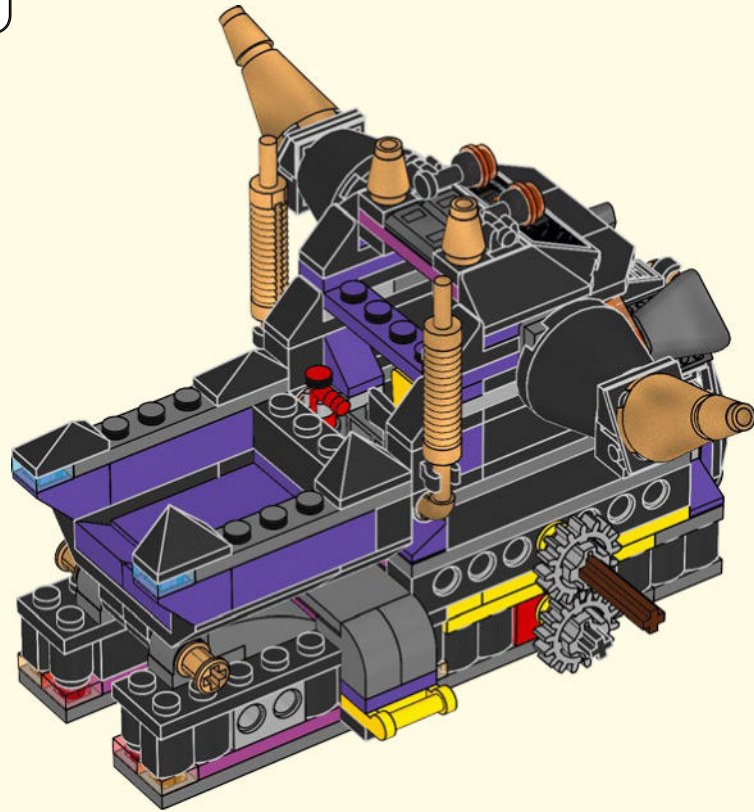



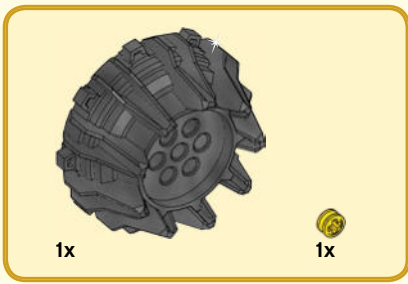

80

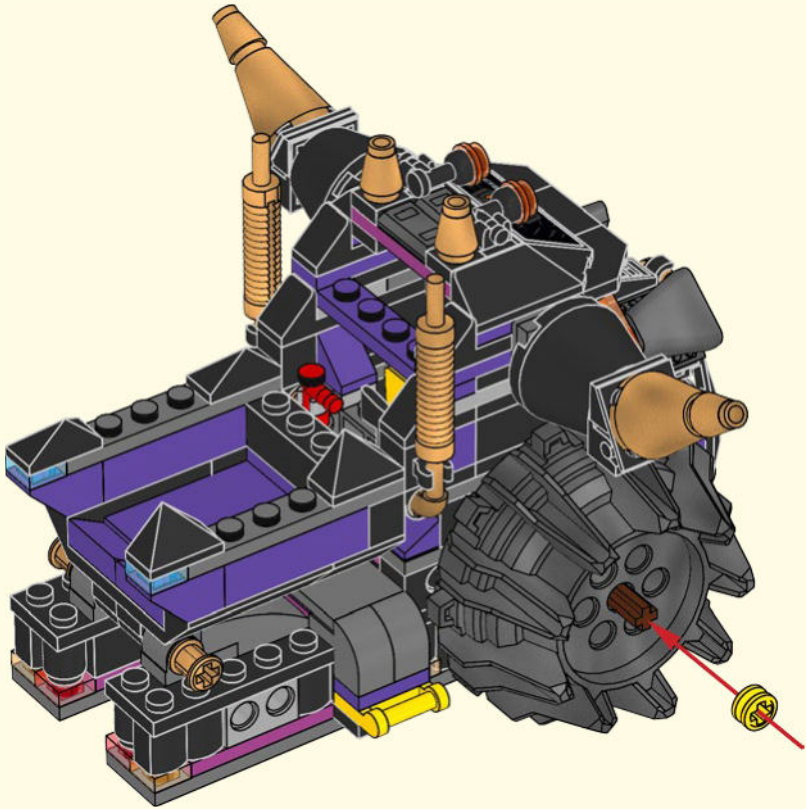



1x



1x

81

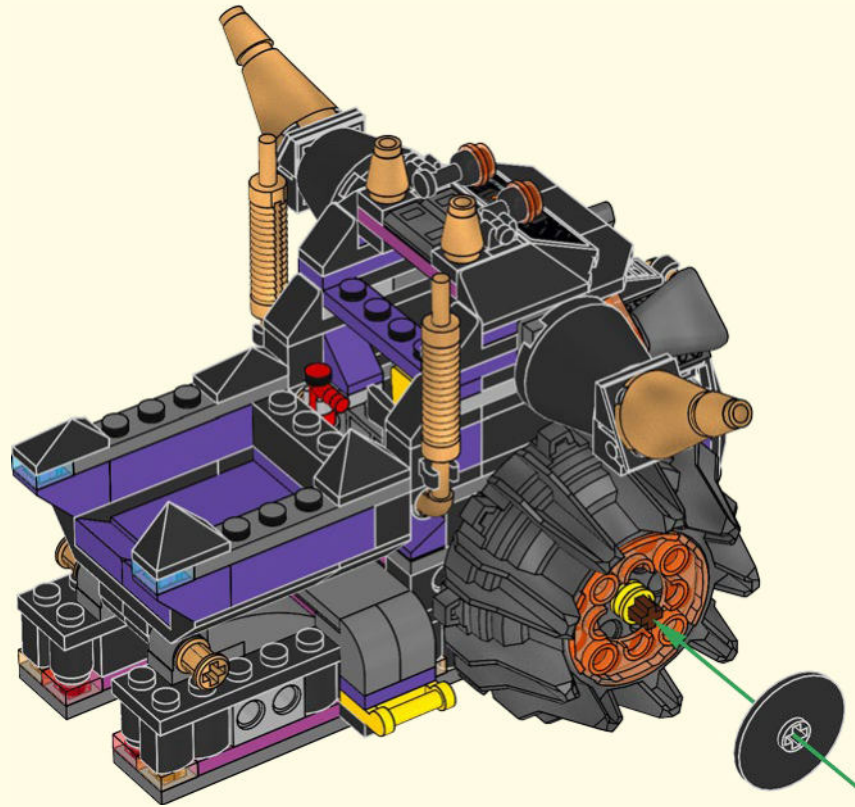



82

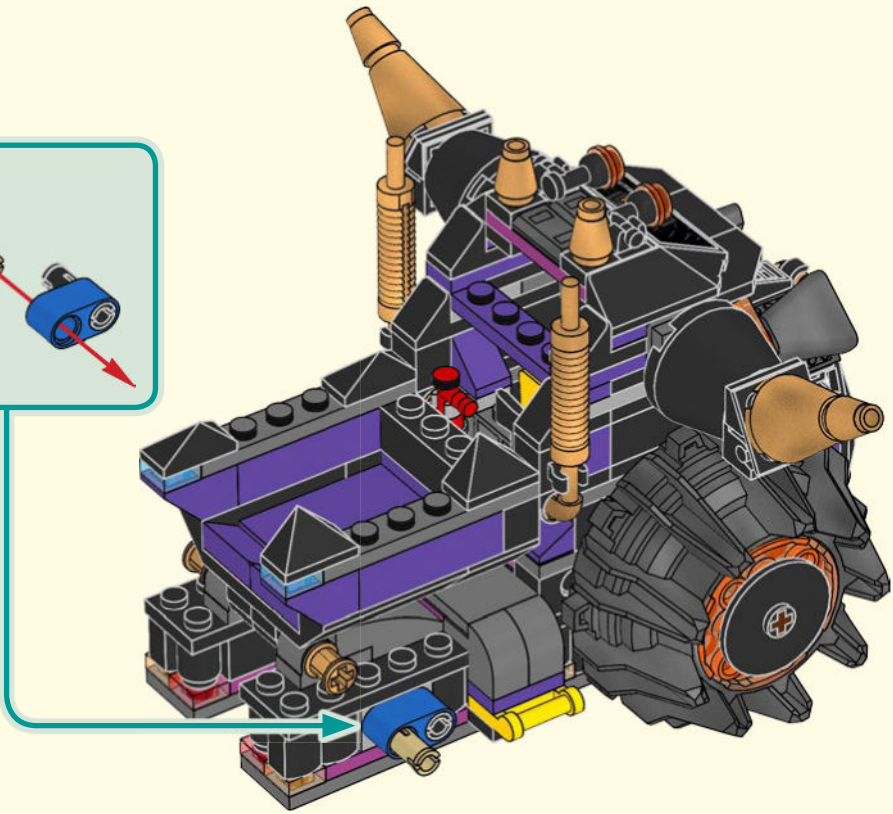
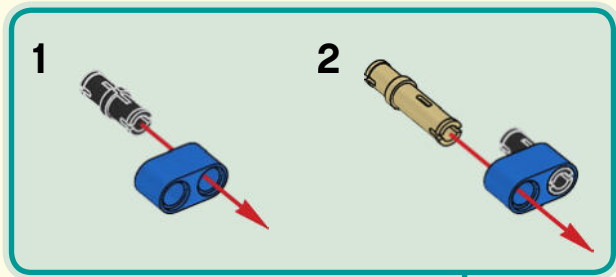



83

1



2

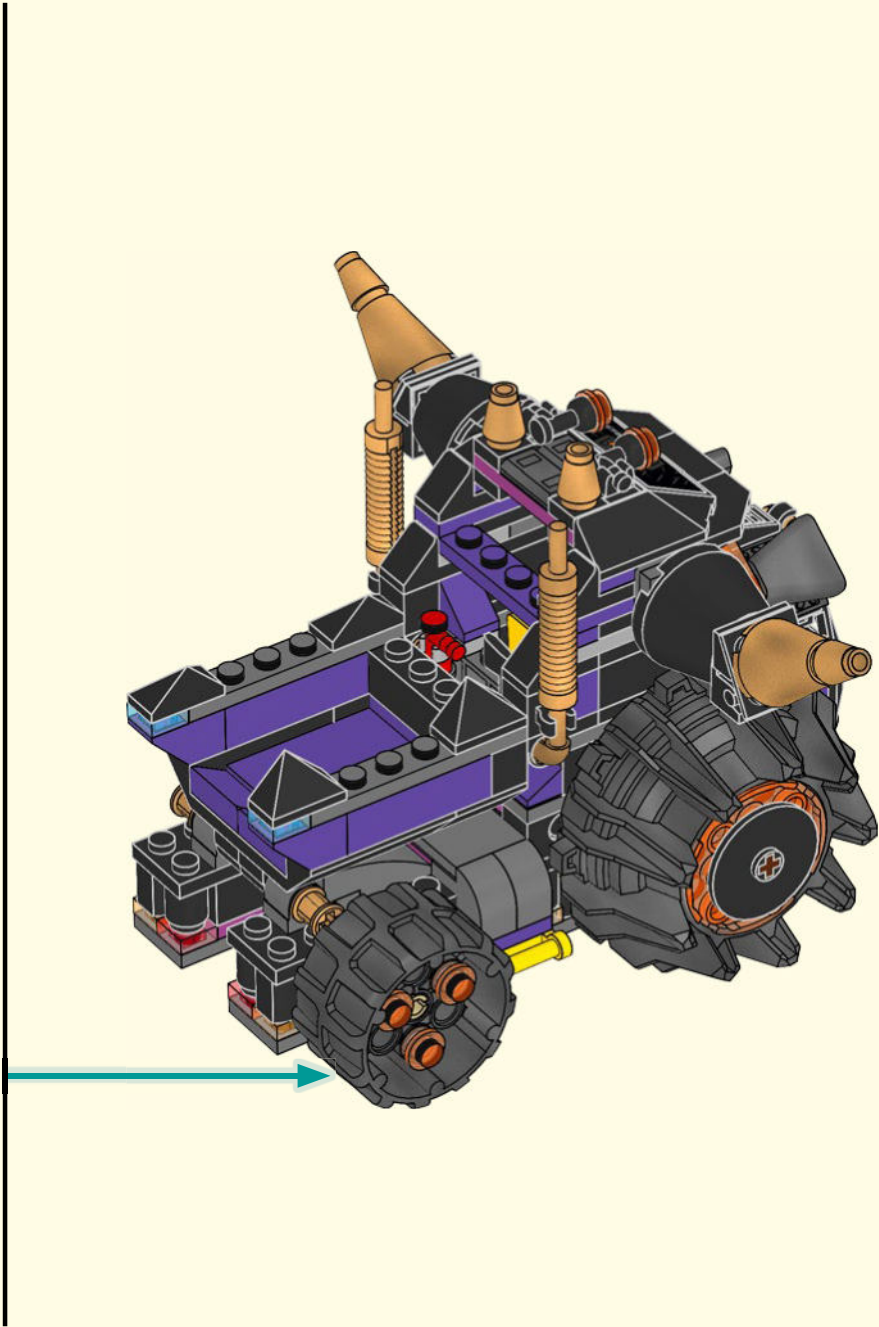
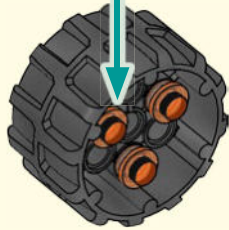
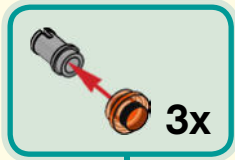



84

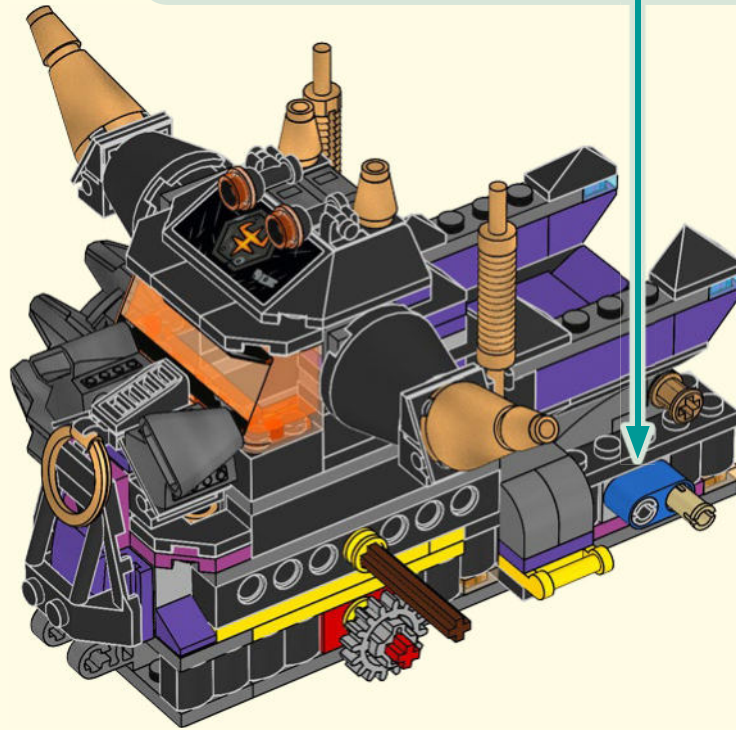
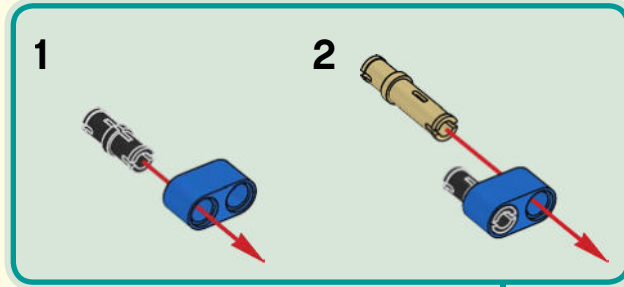

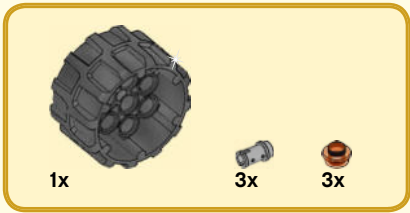

85

1



2

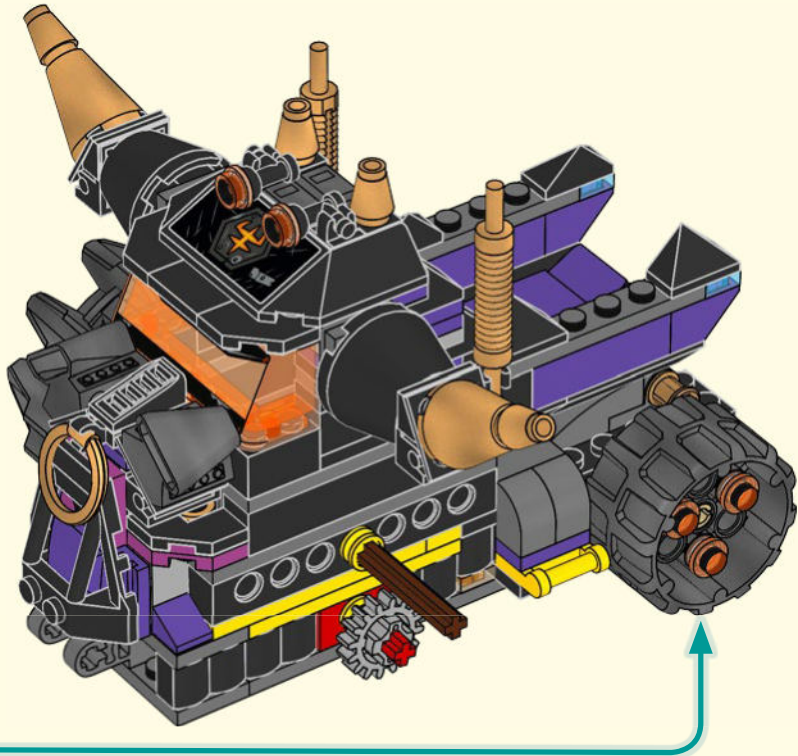
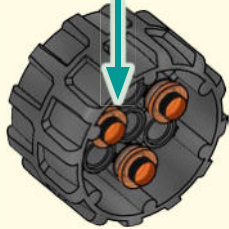
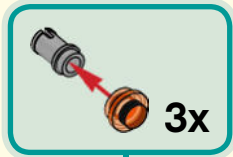



1x

86

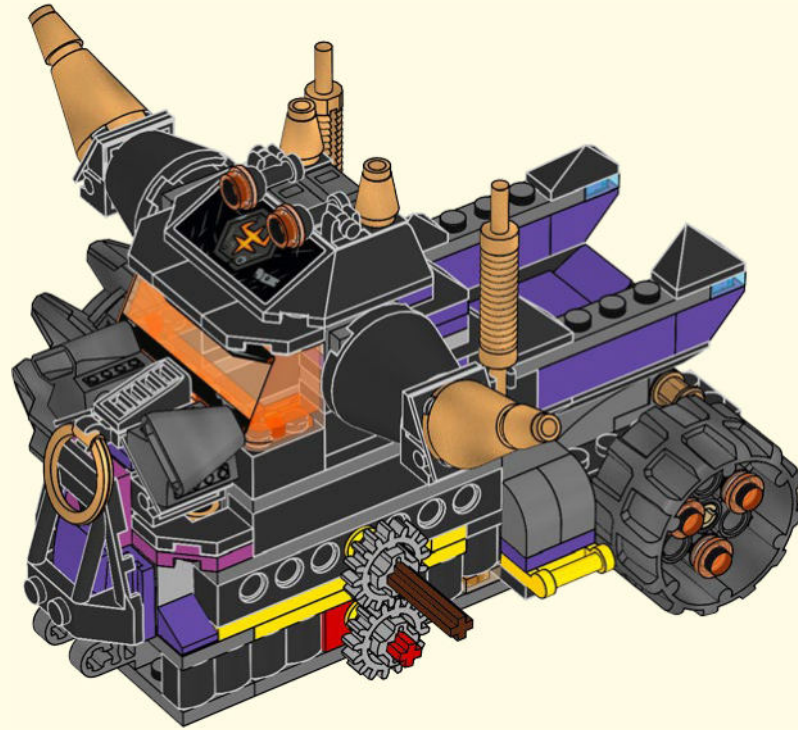

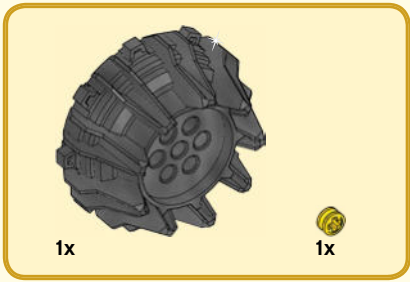

87

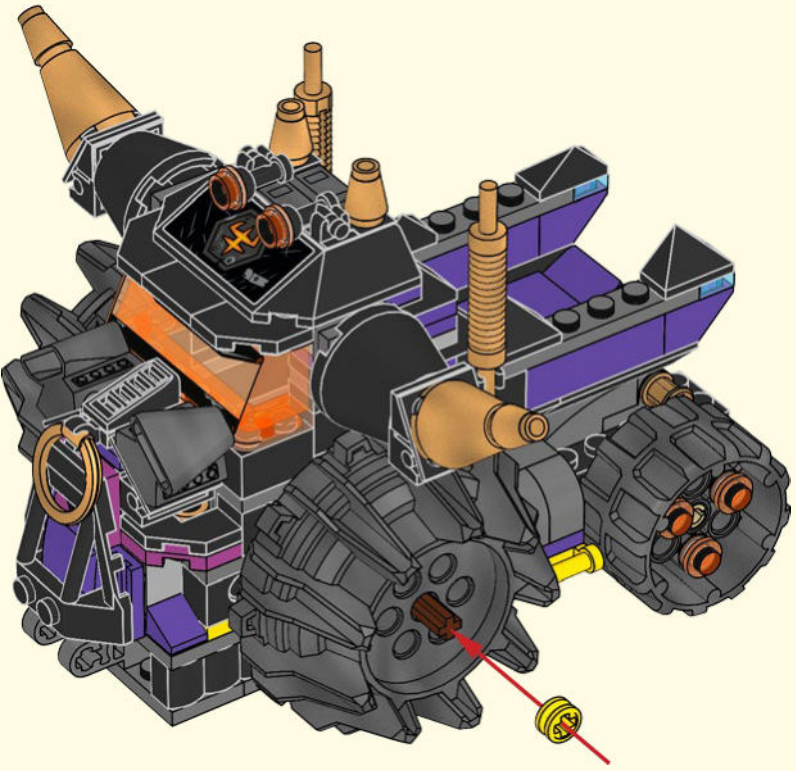



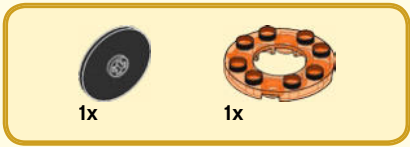

88



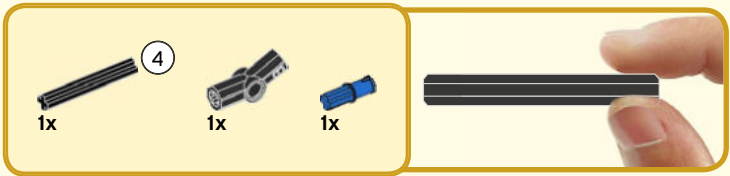

89

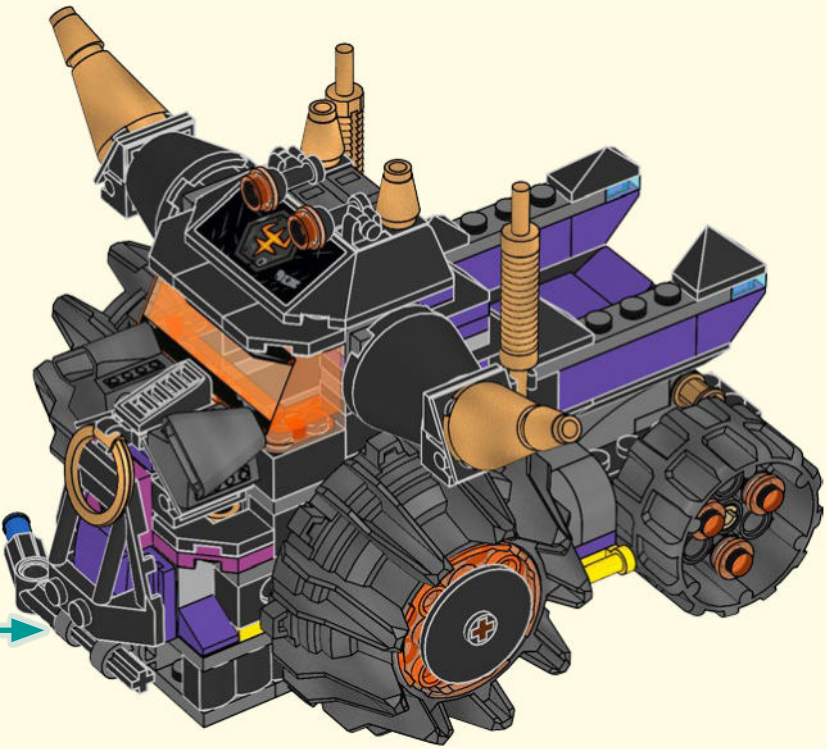
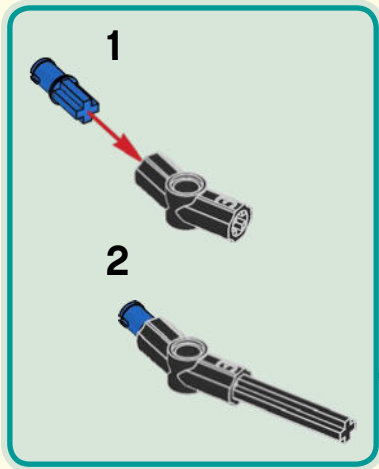



90

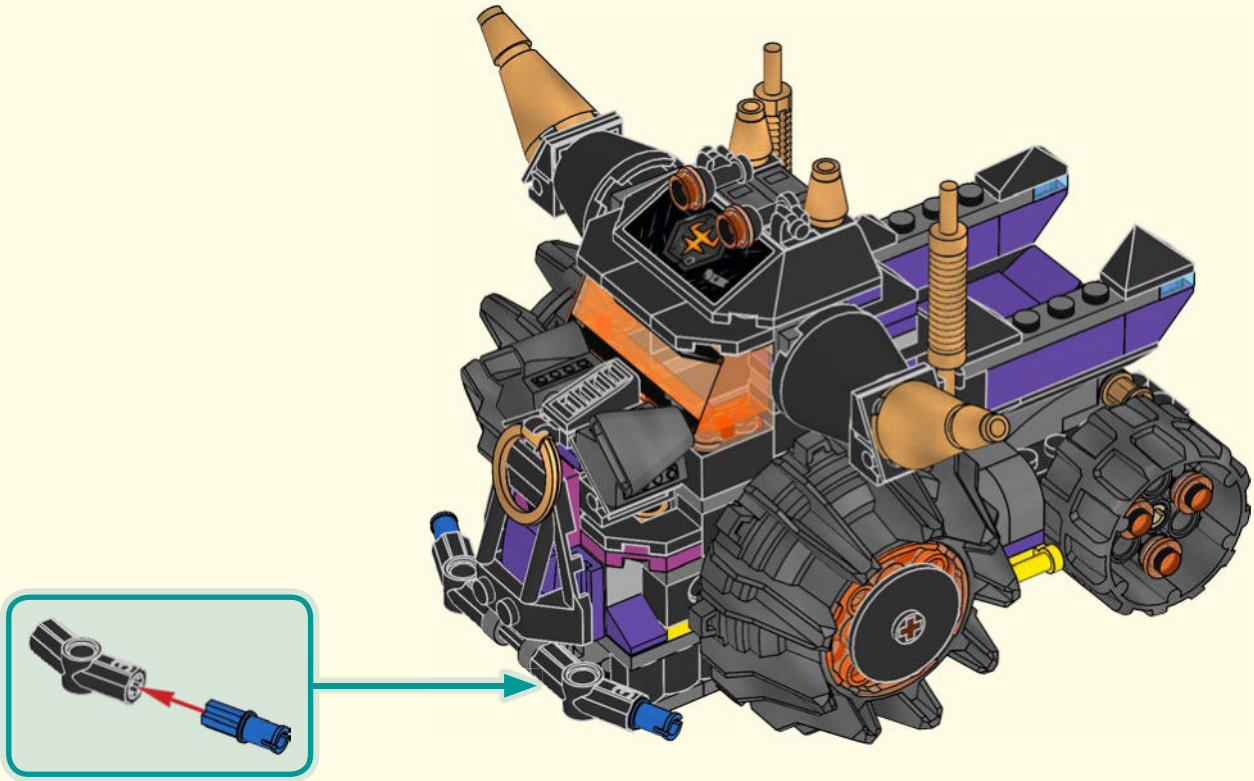

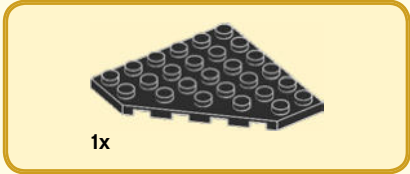

91

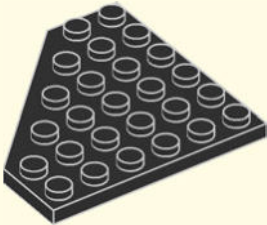

92

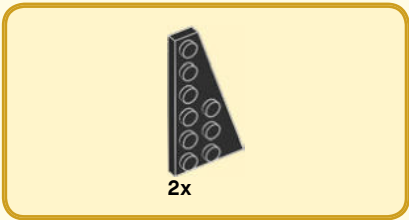
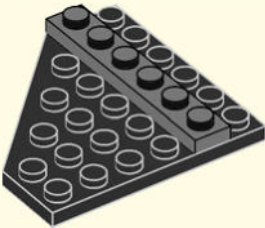

93

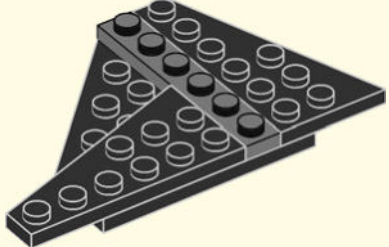



94

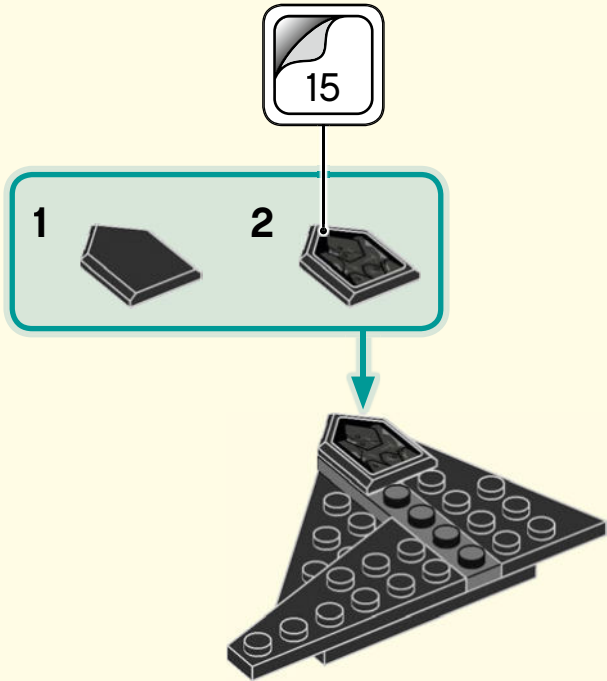

95

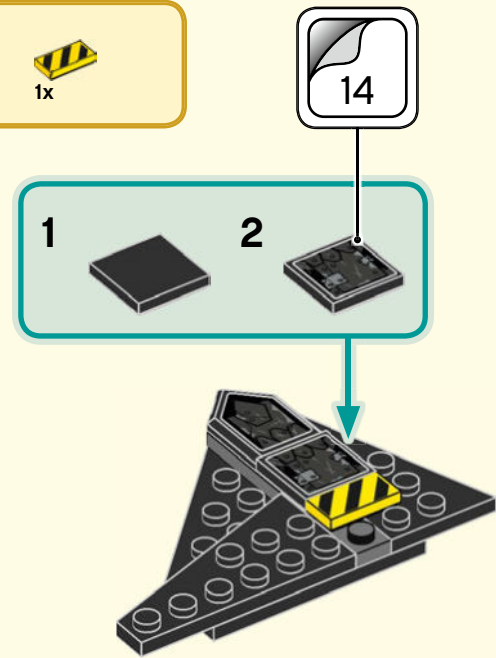

96

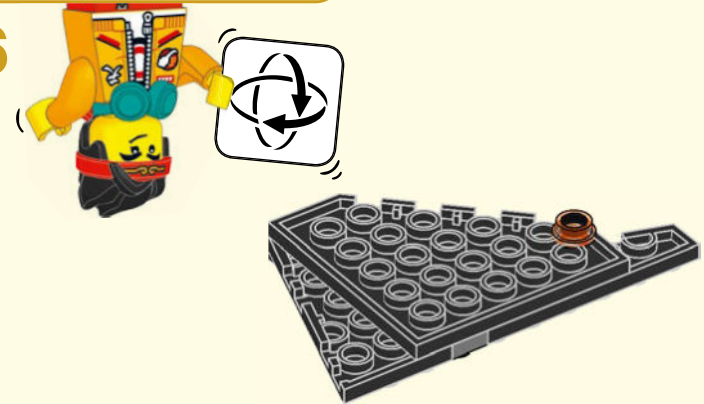



1x



1x

97

1

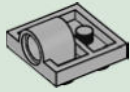

2

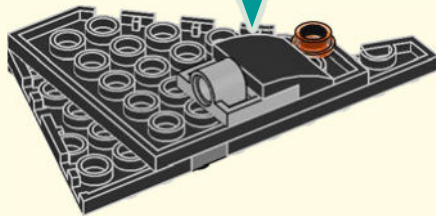
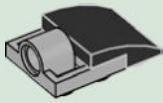

2x

98

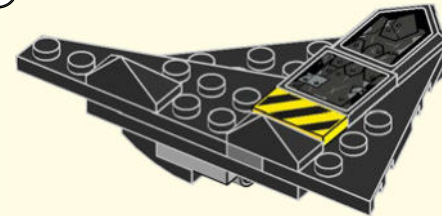
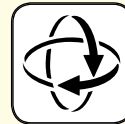

99

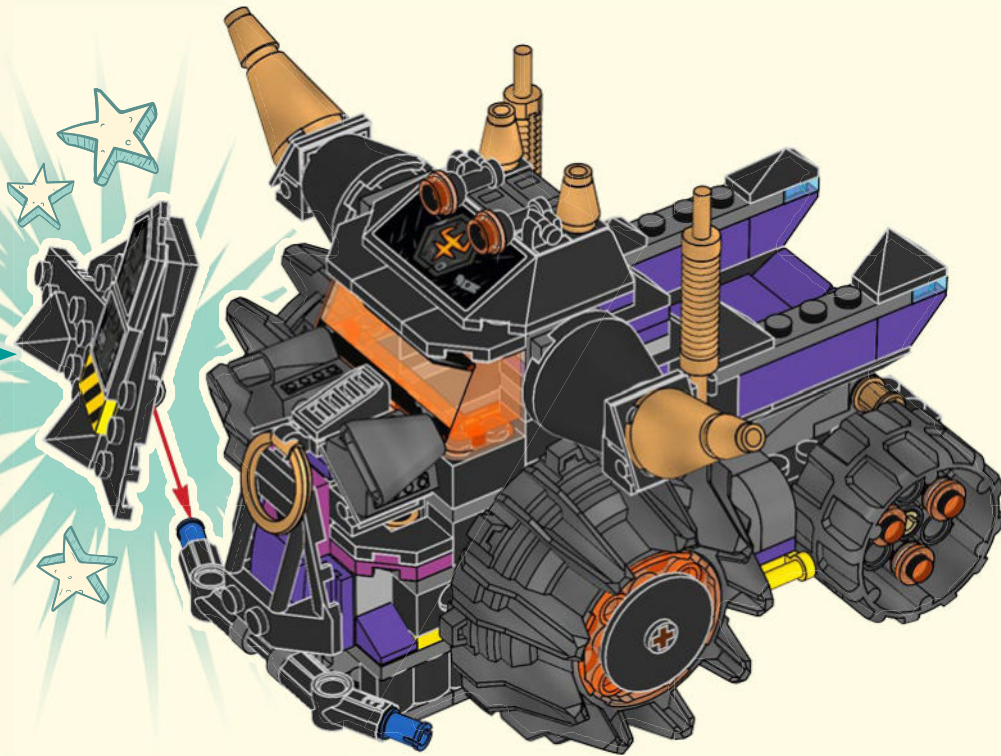

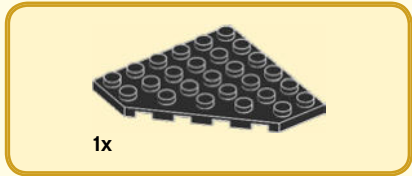

1x

100

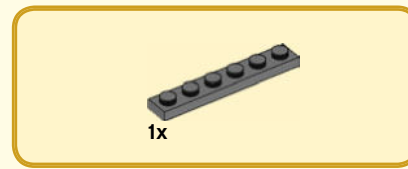
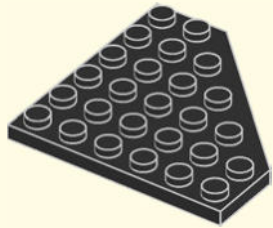

1x

101

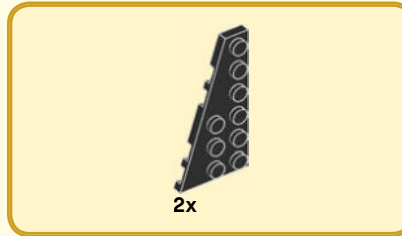
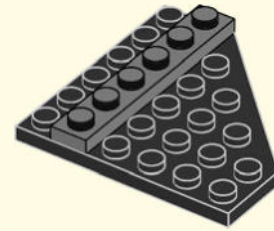

2x

102

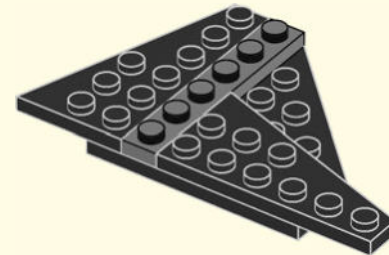





103

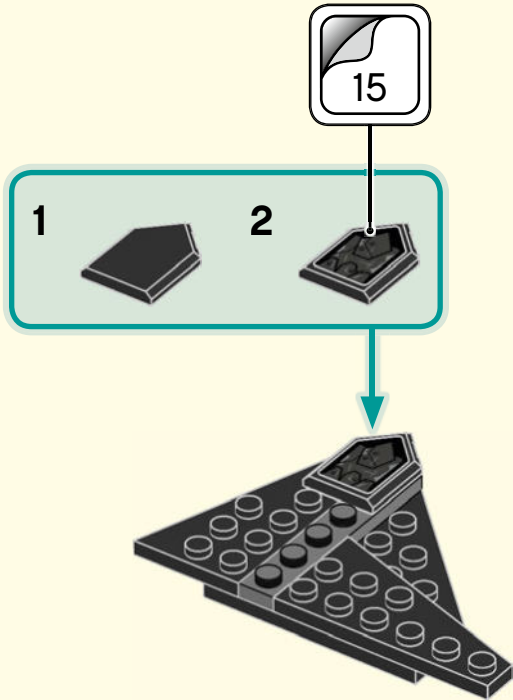

104

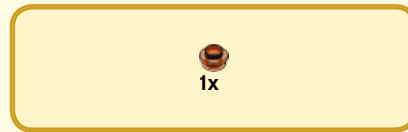
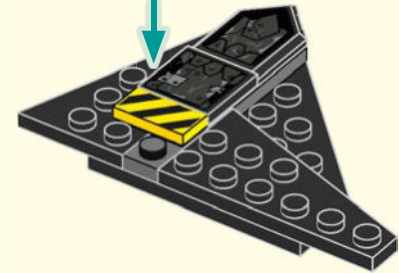

105

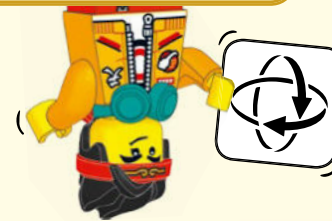



1x



1x

# 106

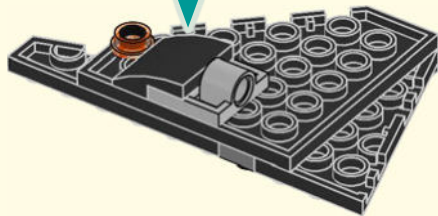
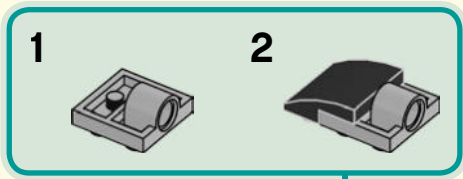

2x

# 107

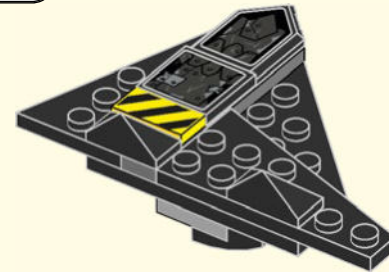
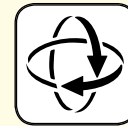

108

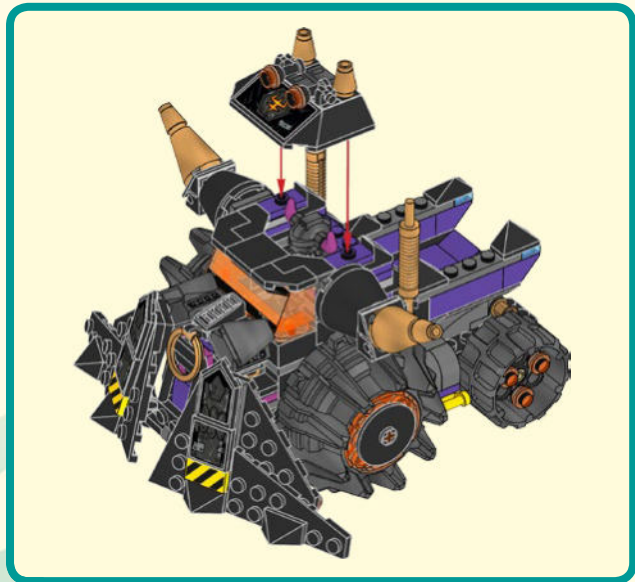
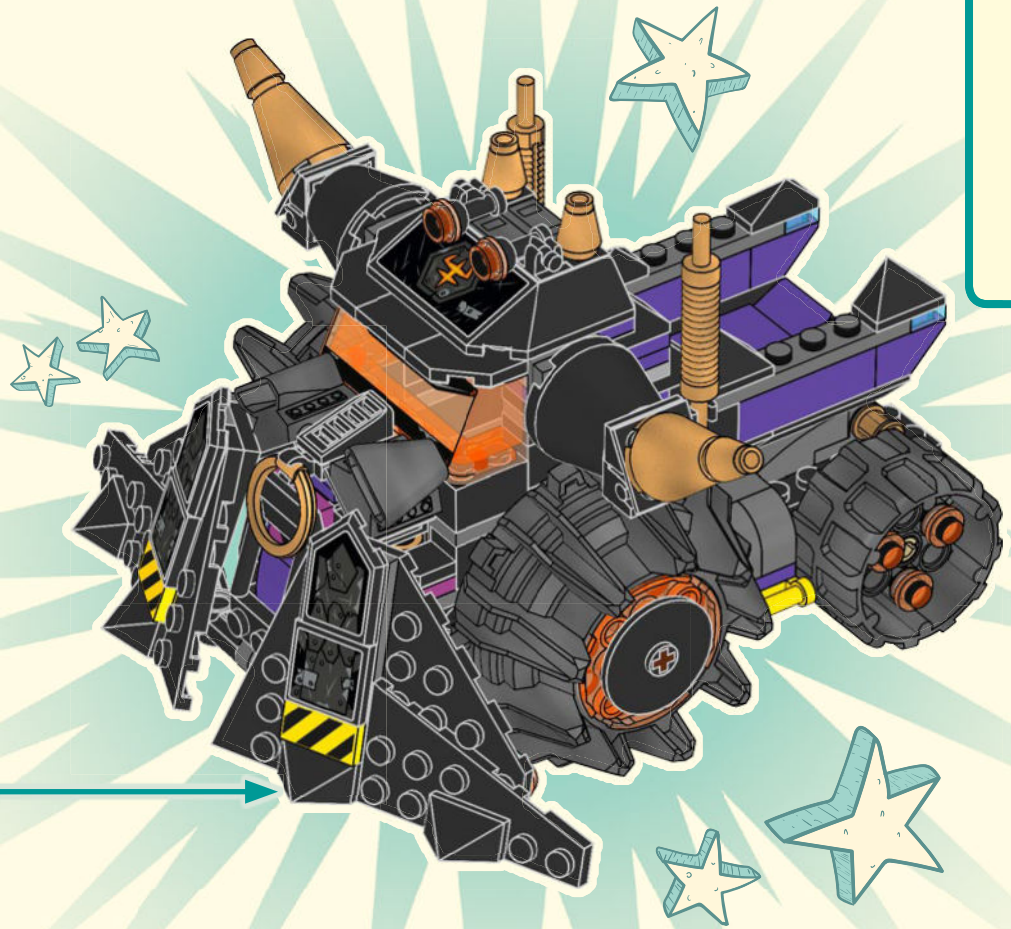

# WIN

GO TO [WWW.LEGO.COM/PRODUCTFEEDBACK](http://WWW.LEGO.COM/PRODUCTFEEDBACK) AND  
GIVE US YOUR SHORT **FEEDBACK** ABOUT THIS  
LEGO® SET FOR A CHANCE TO WIN  
A COOL LEGO PRIZE.

Terms & Conditions apply

## [LEGO.com/productfeedback](http://LEGO.com/productfeedback)

### GEWINNE

Erzähle uns auf  
[www.LEGO.com/productfeedback](http://www.LEGO.com/productfeedback)

etwas über die Erfahrungen, die  
du mit diesem LEGO® Set gemacht  
hast, und sichere dir die Chance  
auf einen coolen LEGO Preis!

Es gelten die  
Teilnahmebedingungen

### GAGNE

Rends-toi sur  
[www.LEGO.com/productfeedback](http://www.LEGO.com/productfeedback)

et donne-nous quelques com-  
mentaires sur ce produit LEGO®  
pour avoir une chance de gagner  
un prix LEGO !

Voir Conditions Générales

### GANAN

Visita  
[www.LEGO.com/productfeedback](http://www.LEGO.com/productfeedback)

y envíanos tu opinión acerca de  
este set LEGO®. ¡Participarás en el  
sorteo de un premio LEGO!

Términos y Condiciones aplicables

### 获取奖品

登录  
[www.LEGO.com/productfeedback](http://www.LEGO.com/productfeedback)

给出关于此乐高®套装的简短反馈，  
就有机会获得炫酷乐高奖品

《条款及条件》适用

### 경품 당첨 기회

[www.LEGO.com/productfeedback](http://www.LEGO.com/productfeedback)

페이지로 이동하여 이 레고® 세트에  
대한 간략한 피드백을 보내 주시고  
멋진 레고 경품을 탈 수 있는 기회도  
잡으십시오

약관 적용

### ЗАПОЛНИ АНКЕТУ И ПОЛУЧИ ПРИЗ

Перейди по ссылке  
[www.LEGO.com/productfeedback](http://www.LEGO.com/productfeedback)

ответь всего на несколько во-  
просов об этом наборе LEGO®,  
и у тебя появится шанс выиграть  
замечательный приз от компании  
LEGO.

Применяются Условия и правила  
участия



# MONKIE KID 悟空小侠™

80016

2



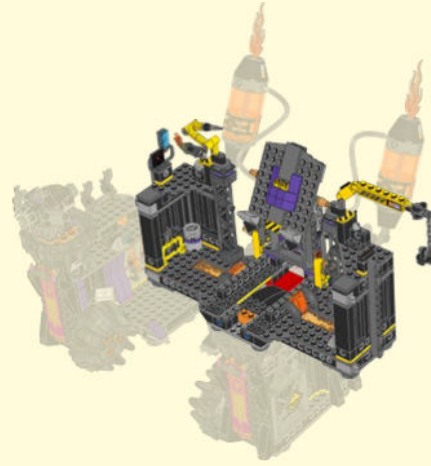
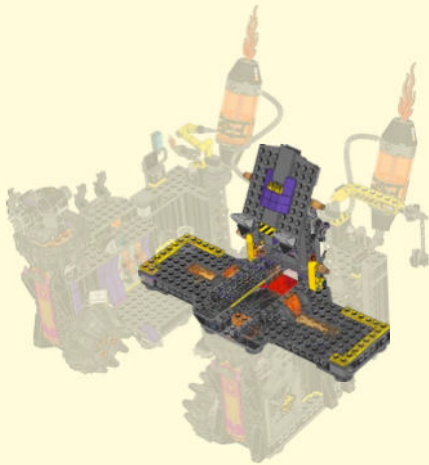
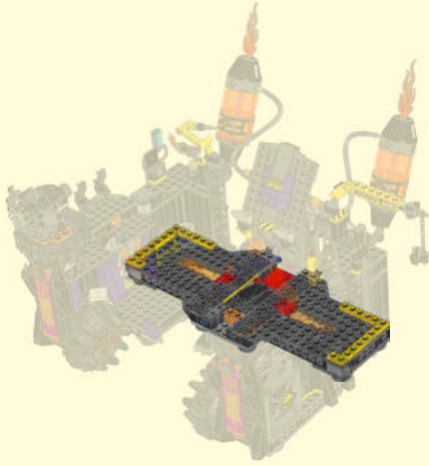

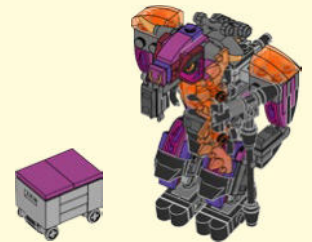
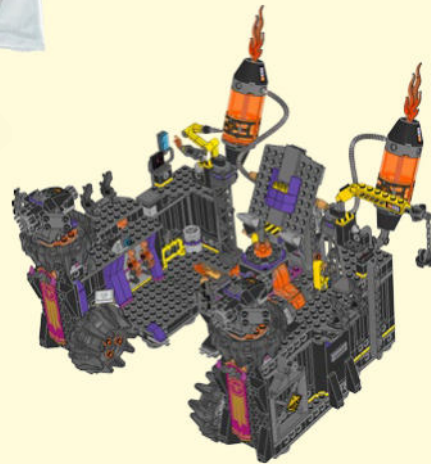
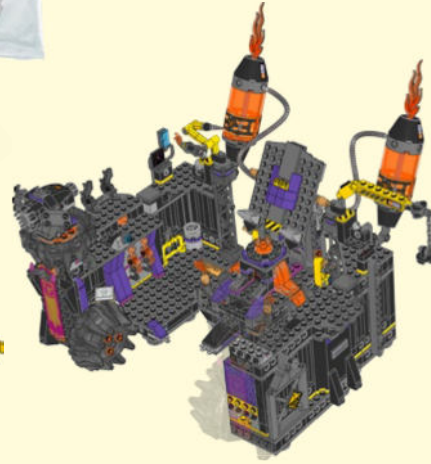







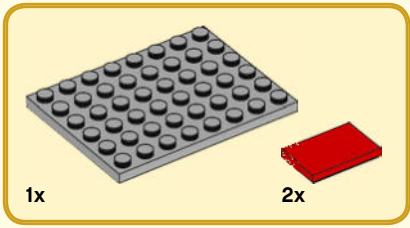

1

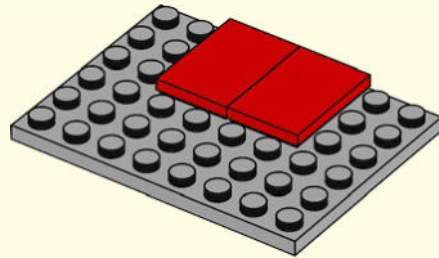



2

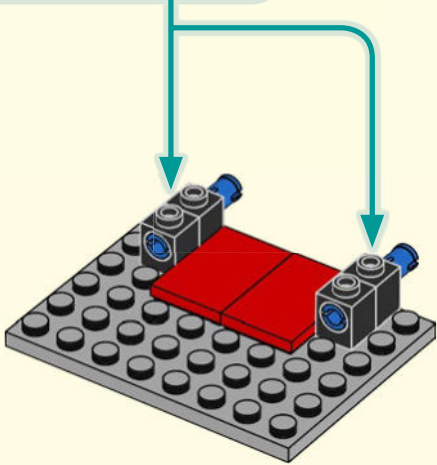
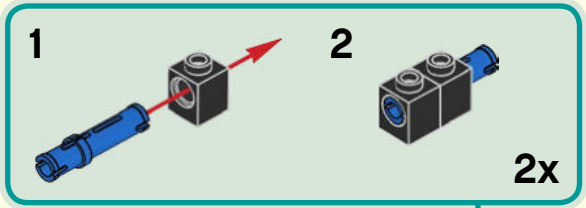

3

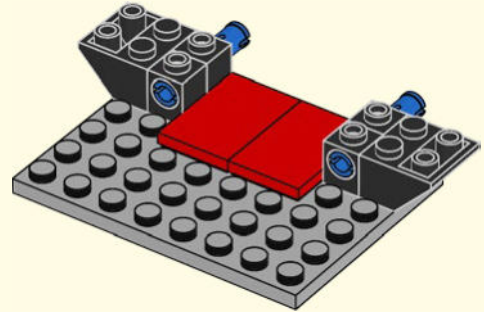

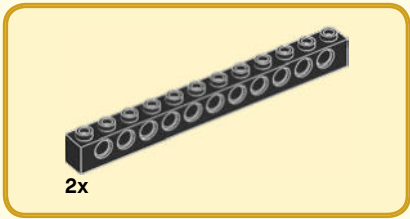

4

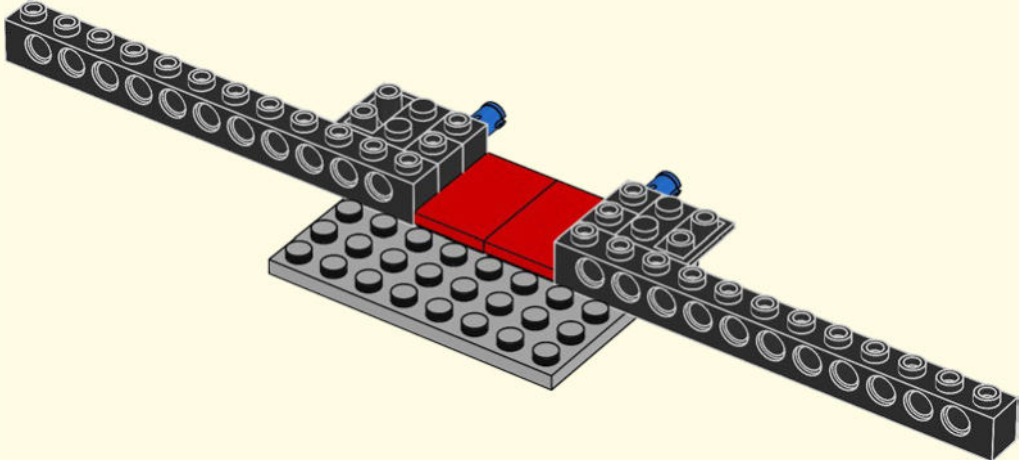



5

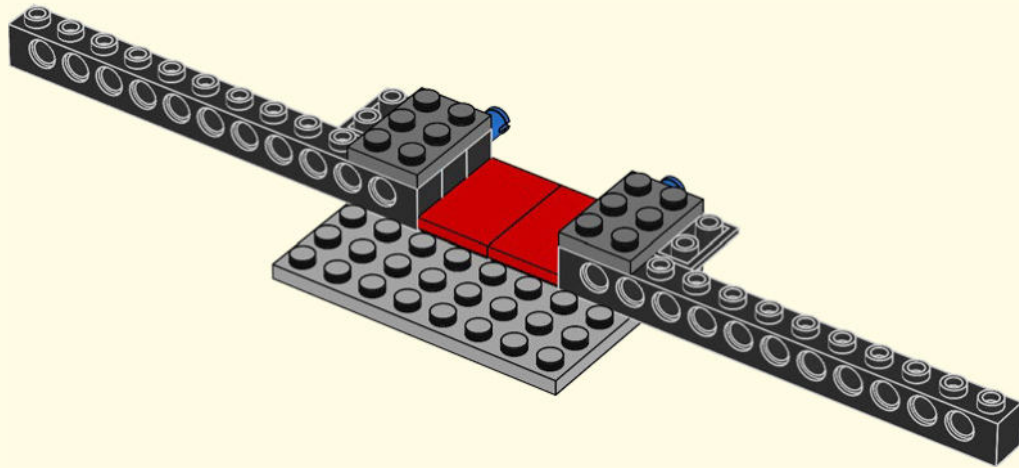

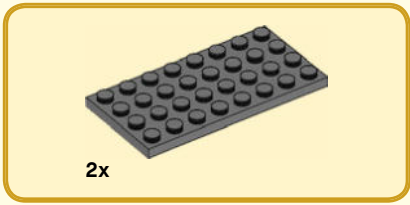

6

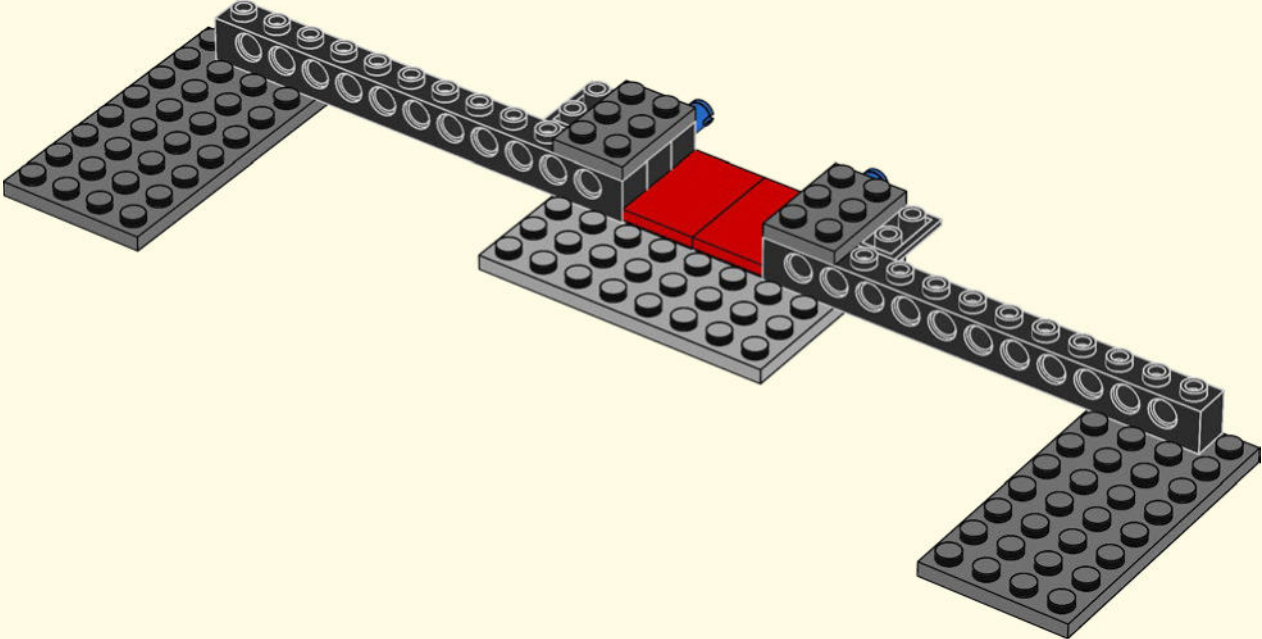



7

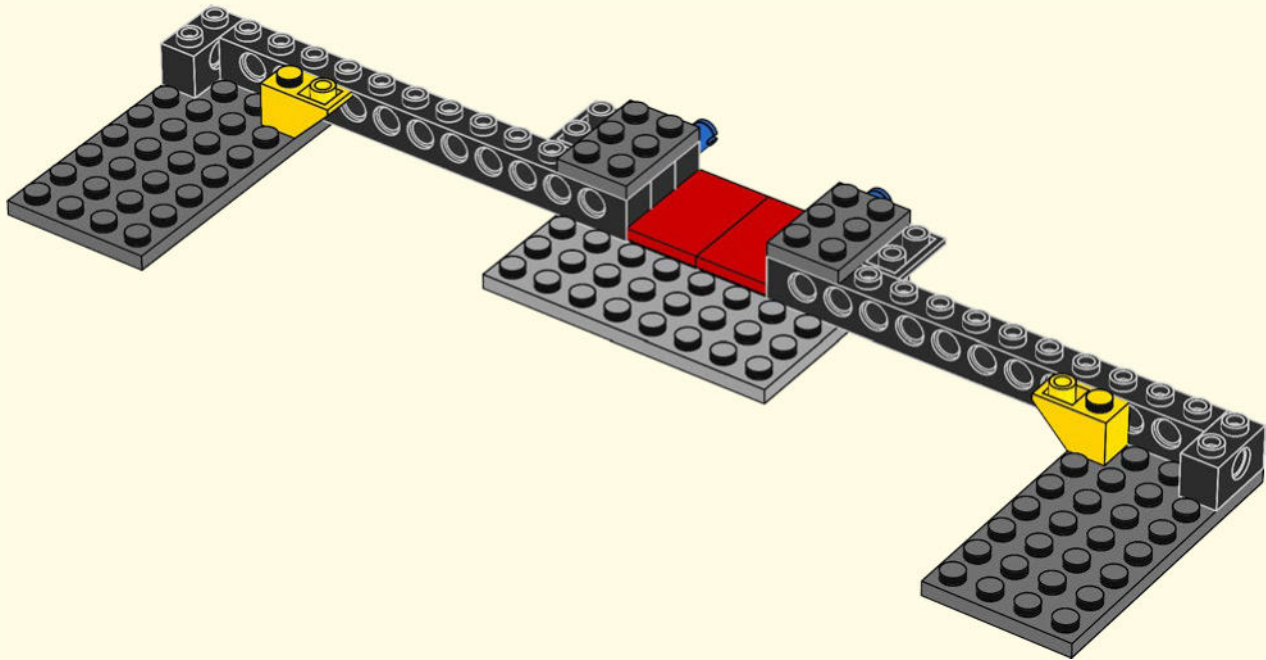



2x

8

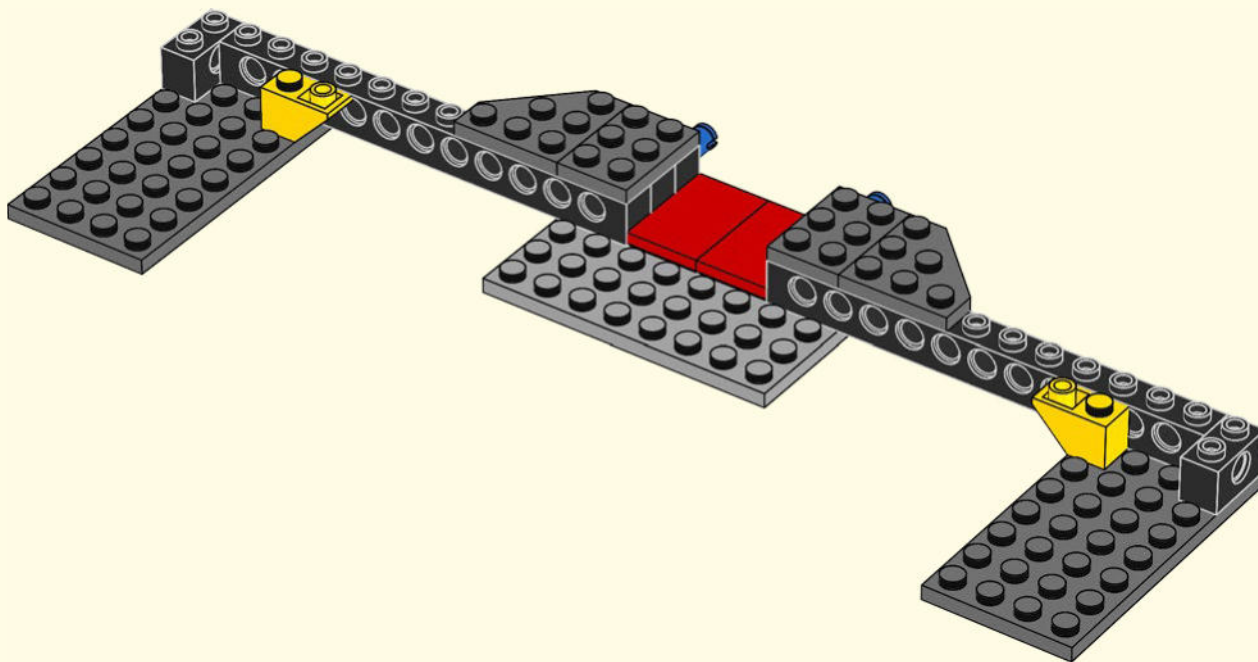



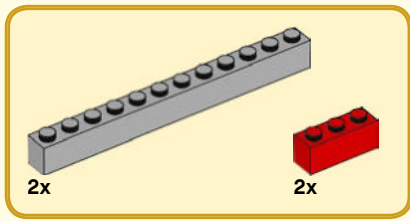

9

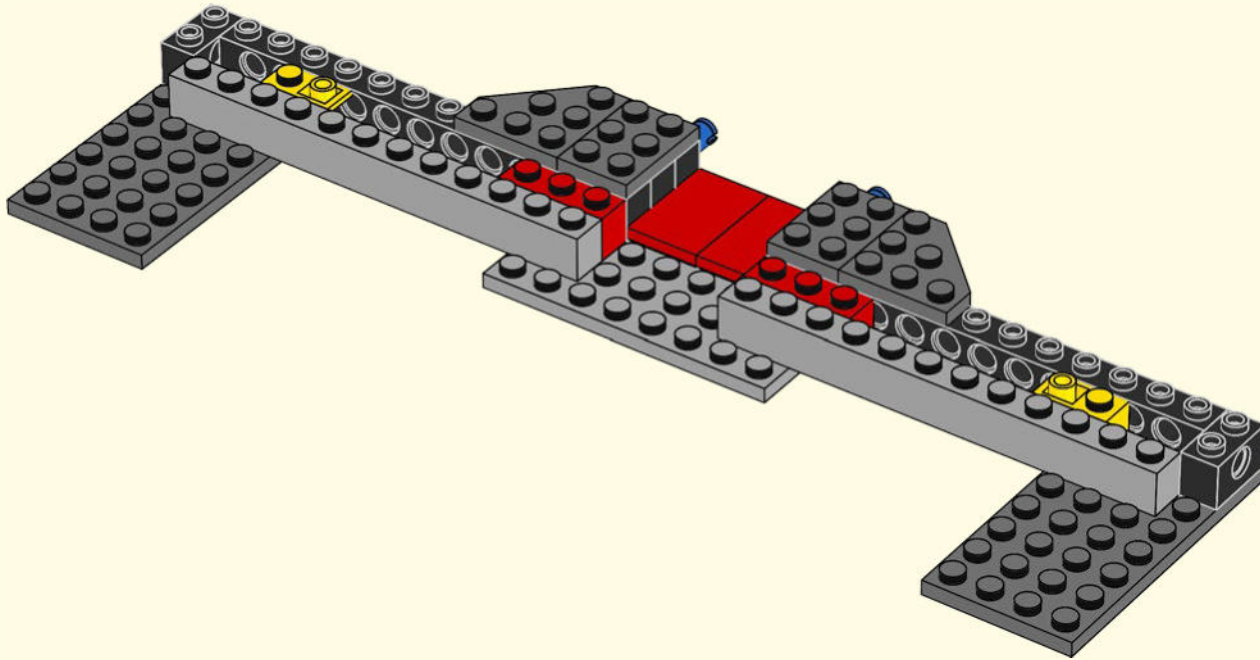



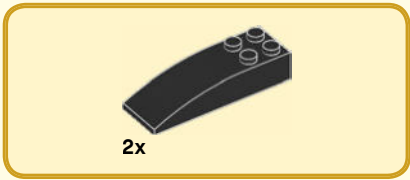

11

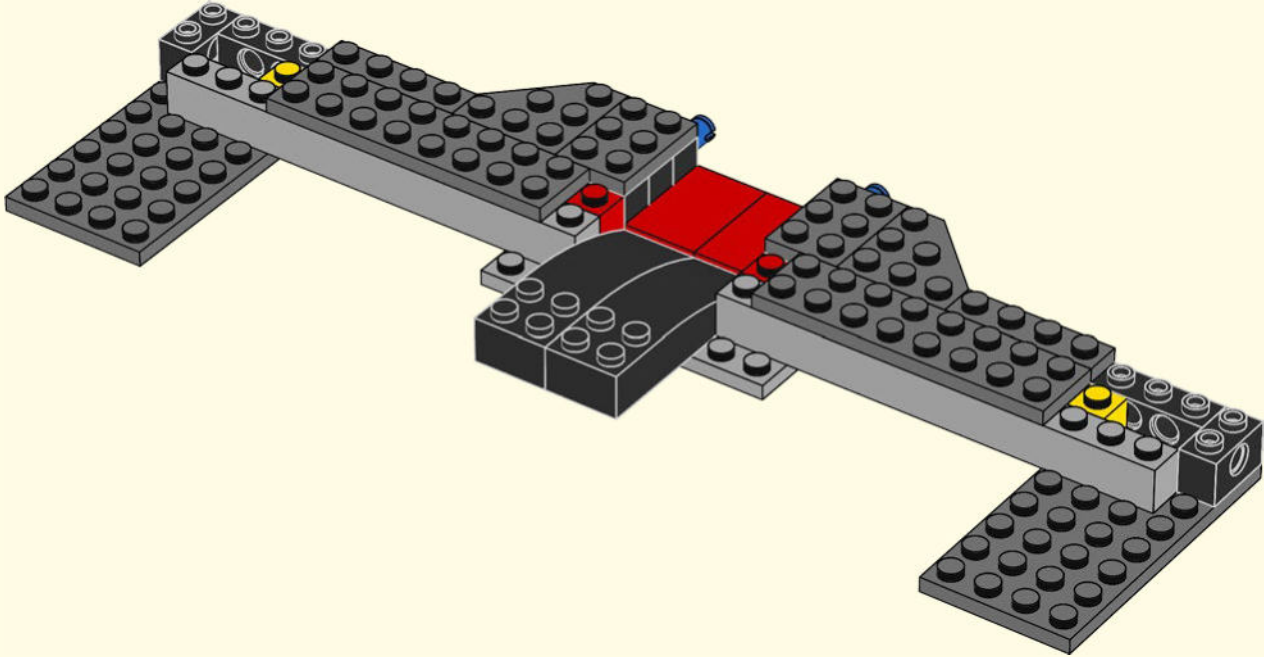

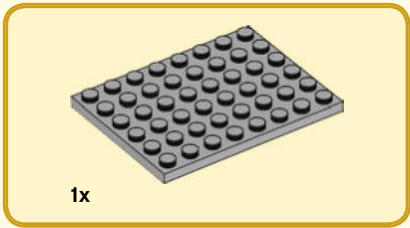

12

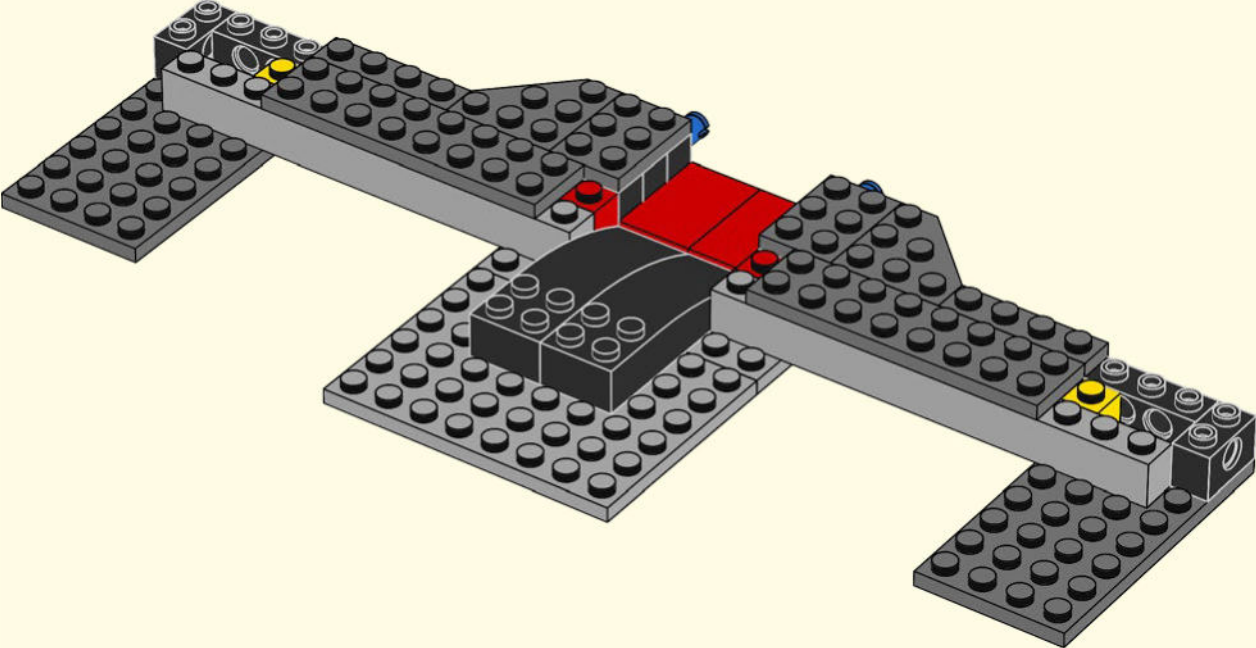

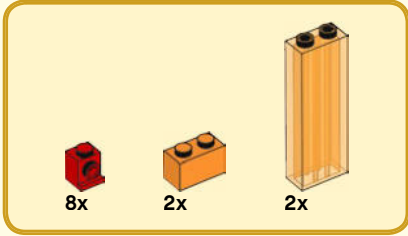

13

1

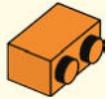

2

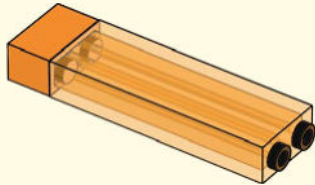

3



4

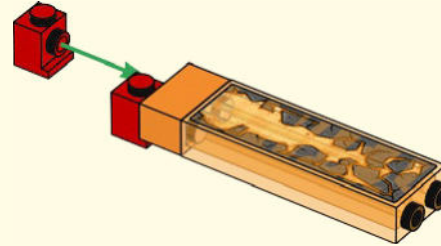

5

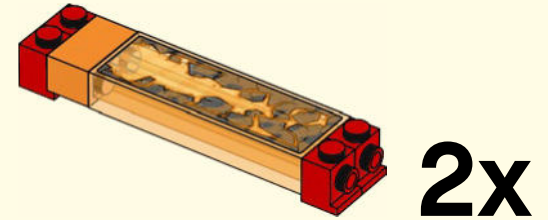

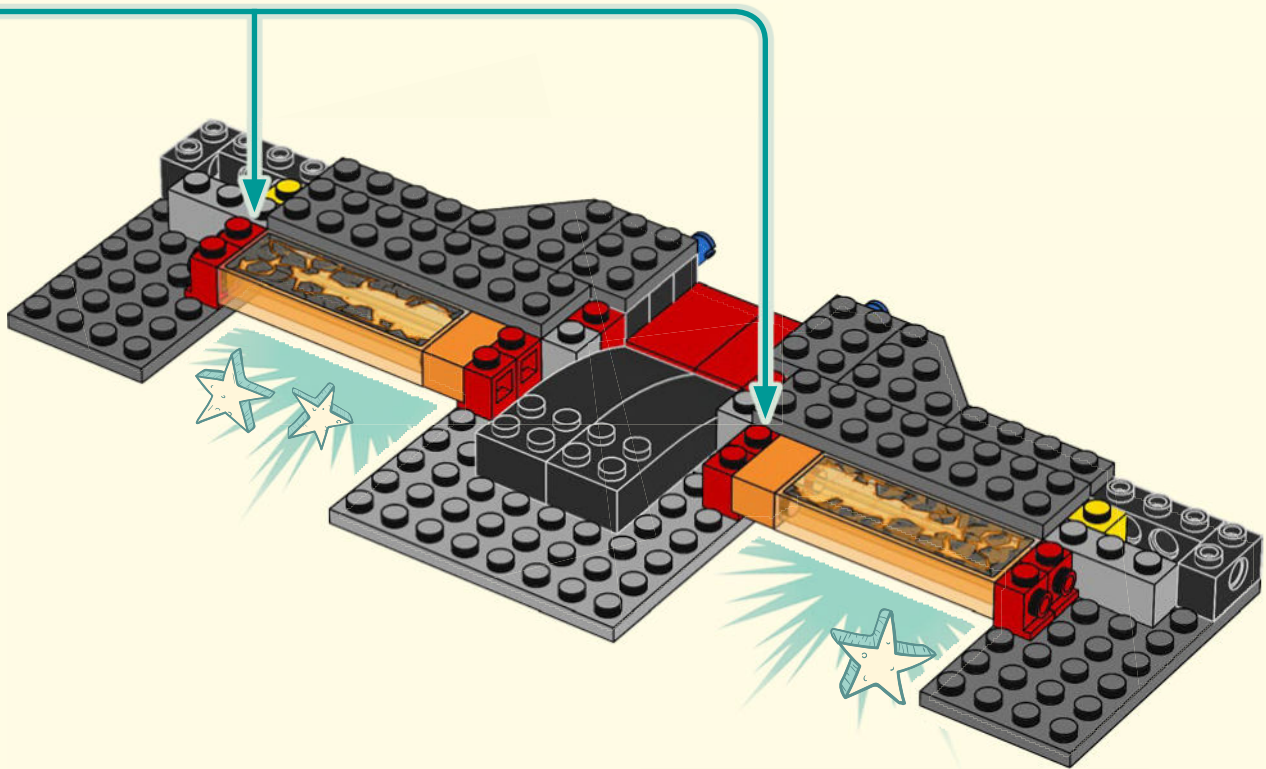

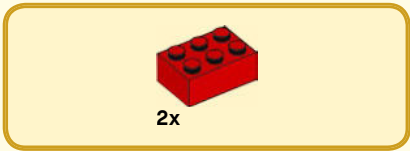

14

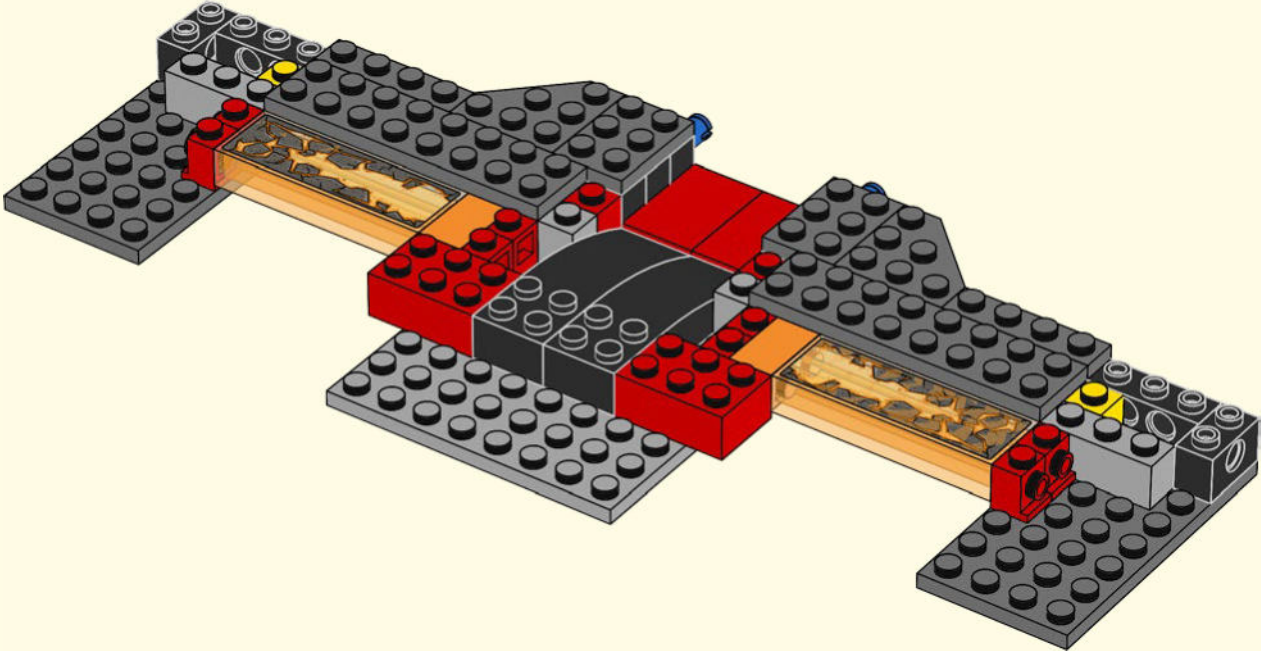



15

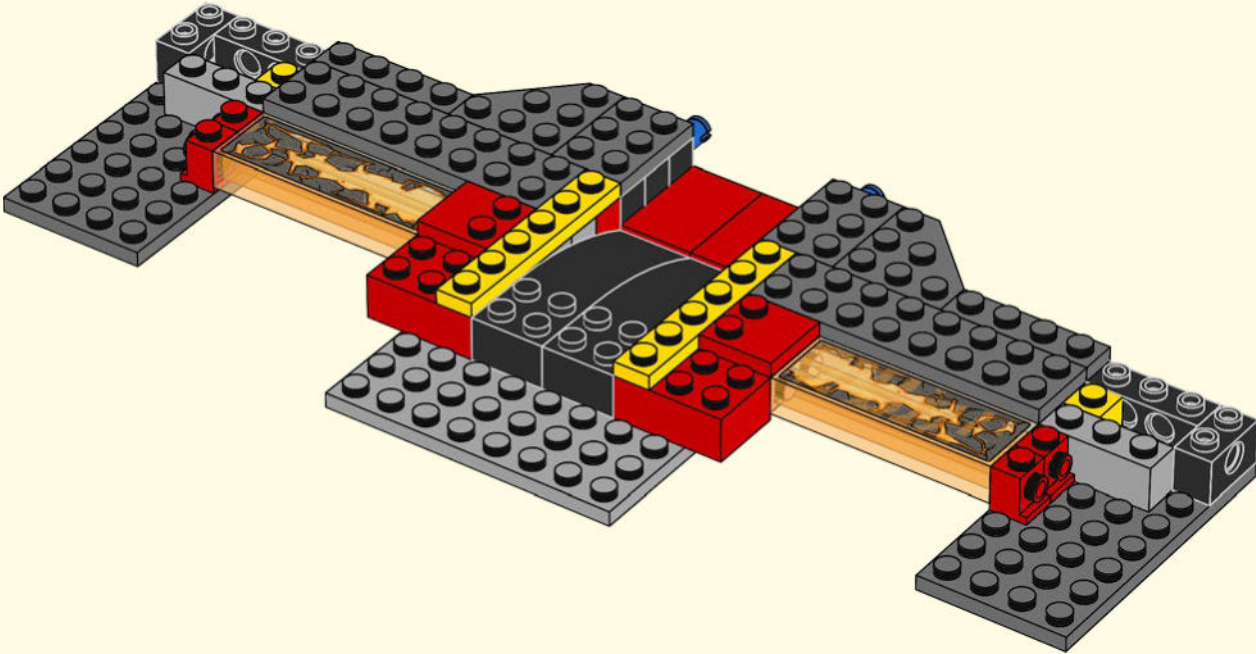





16

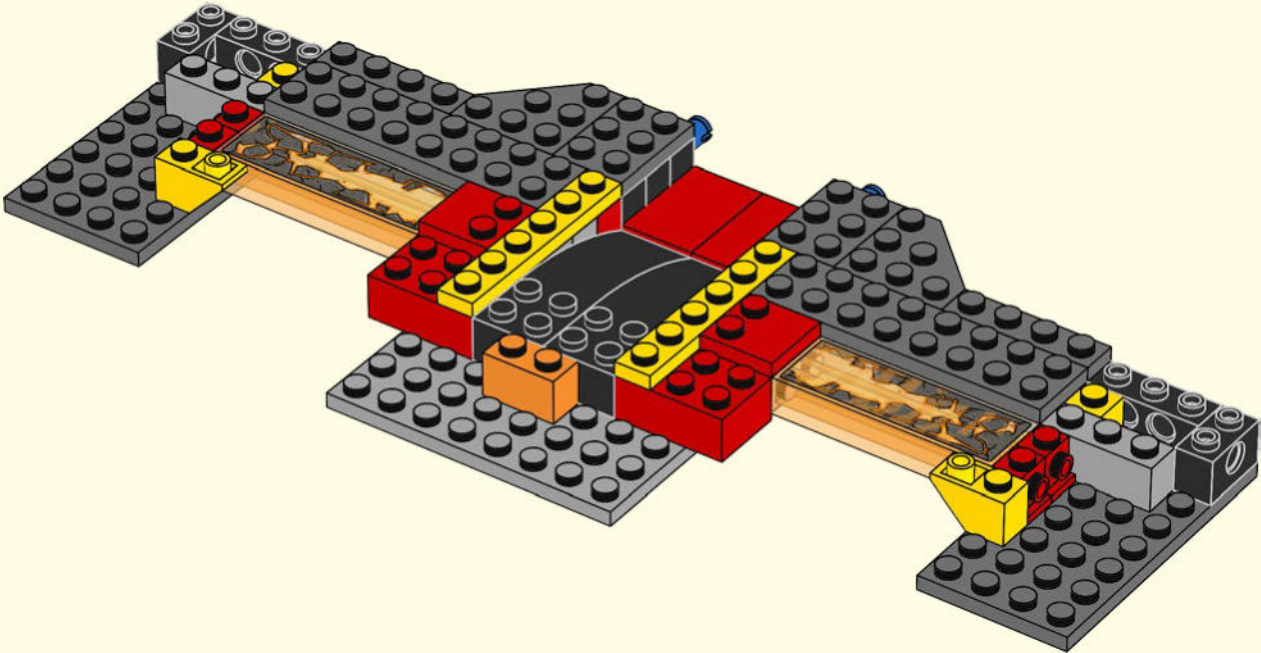

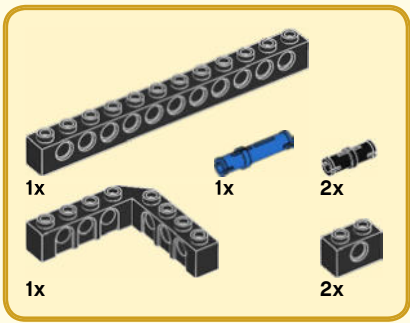

17

1

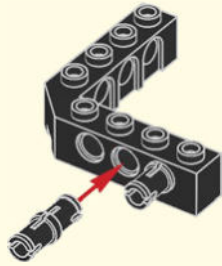

2

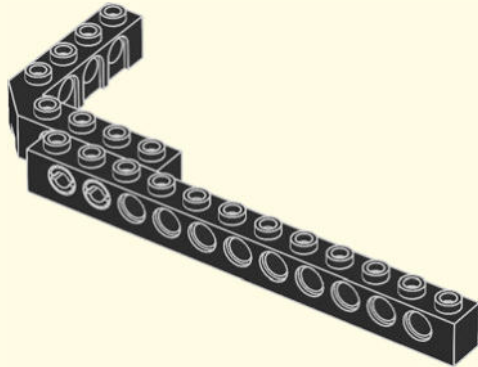

3

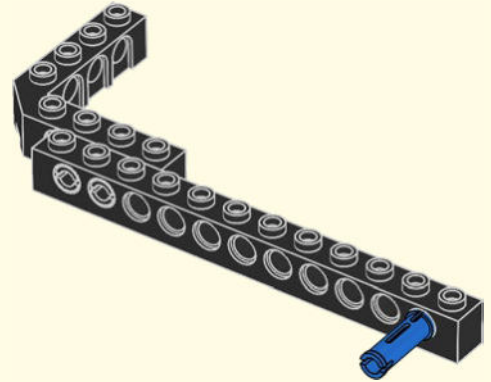

4

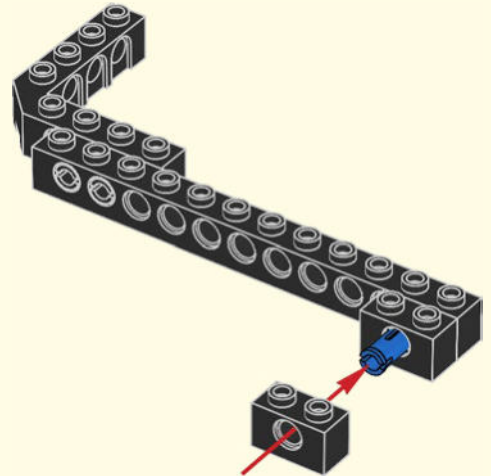

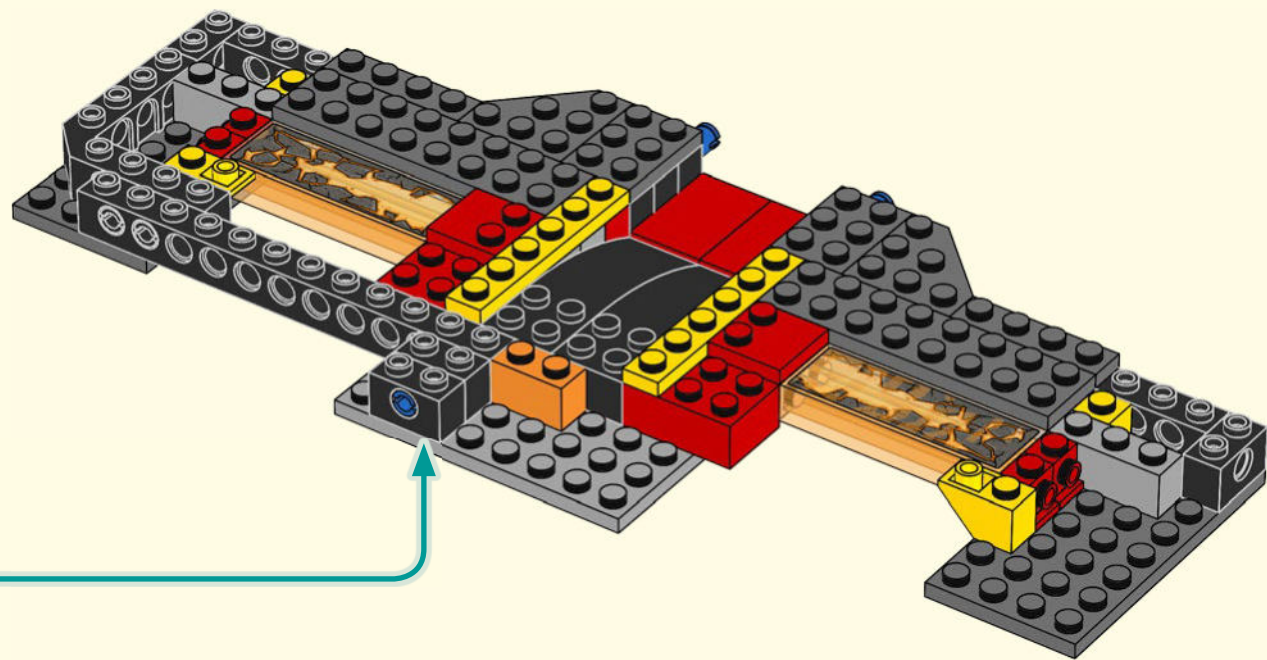

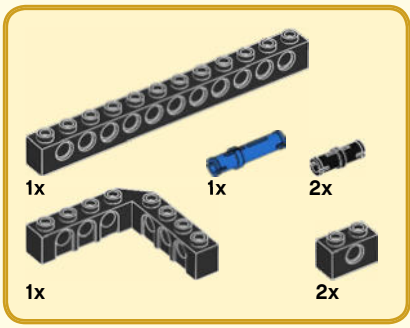

# 18

1

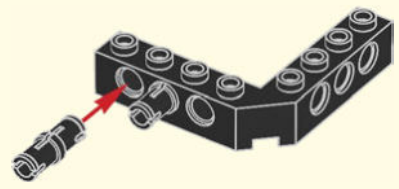

2

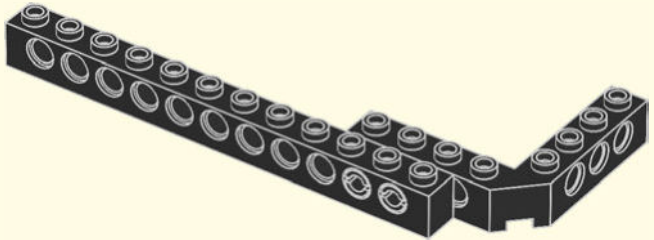

3

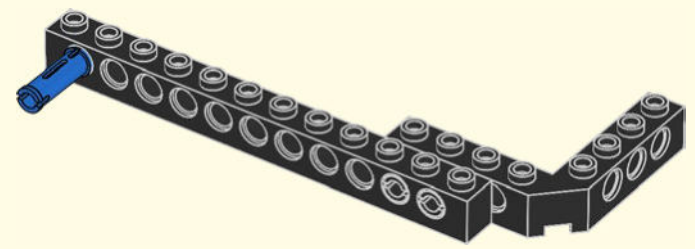

4

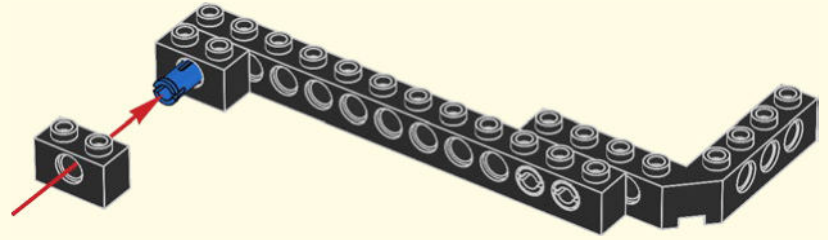

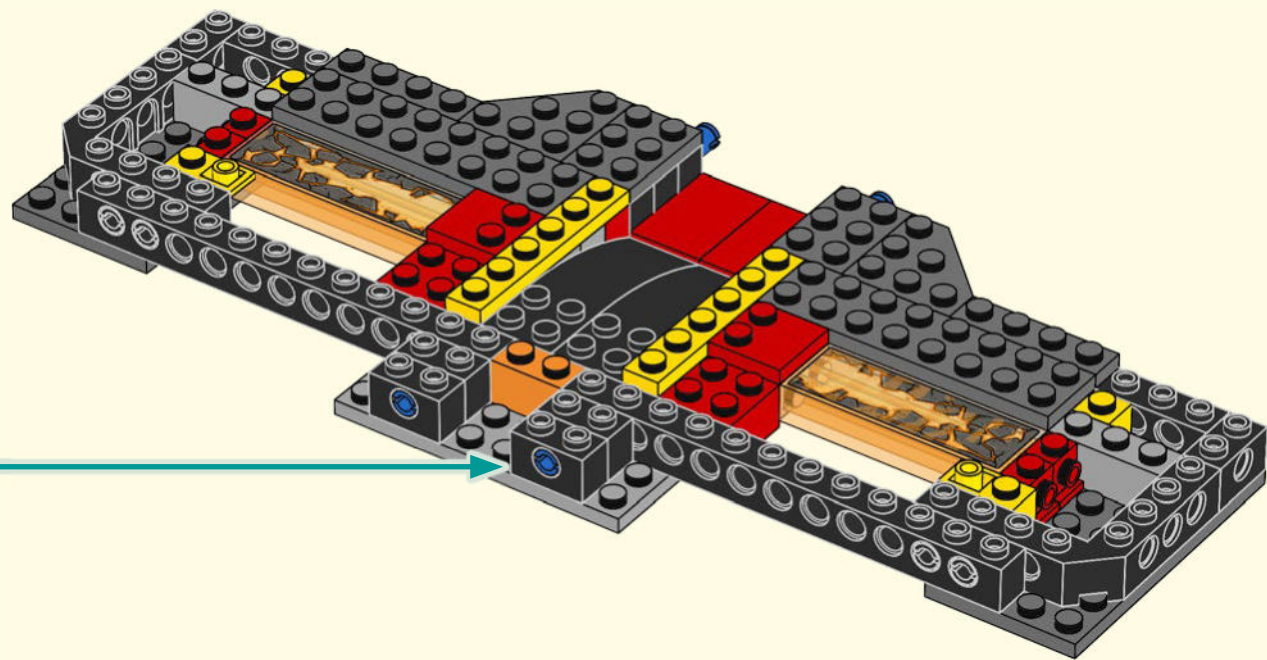



2x



2x

19

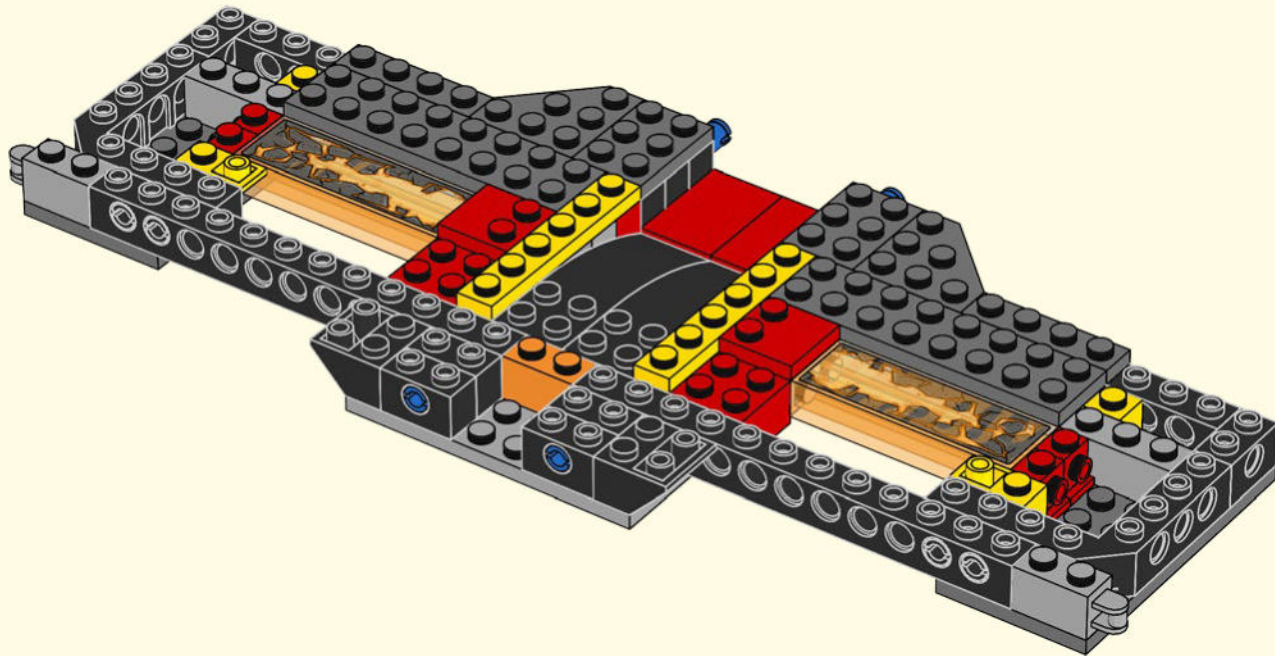



20

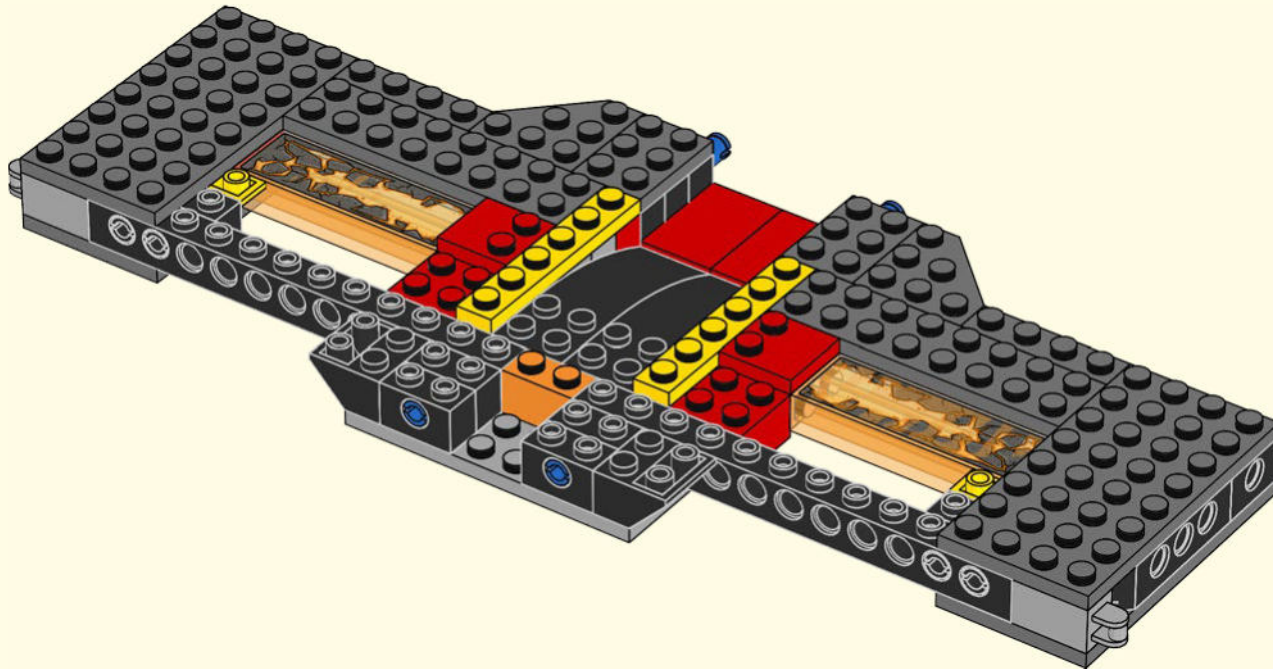

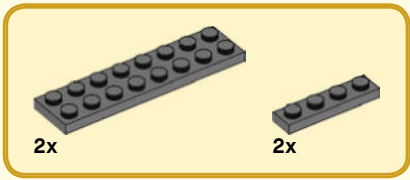

21

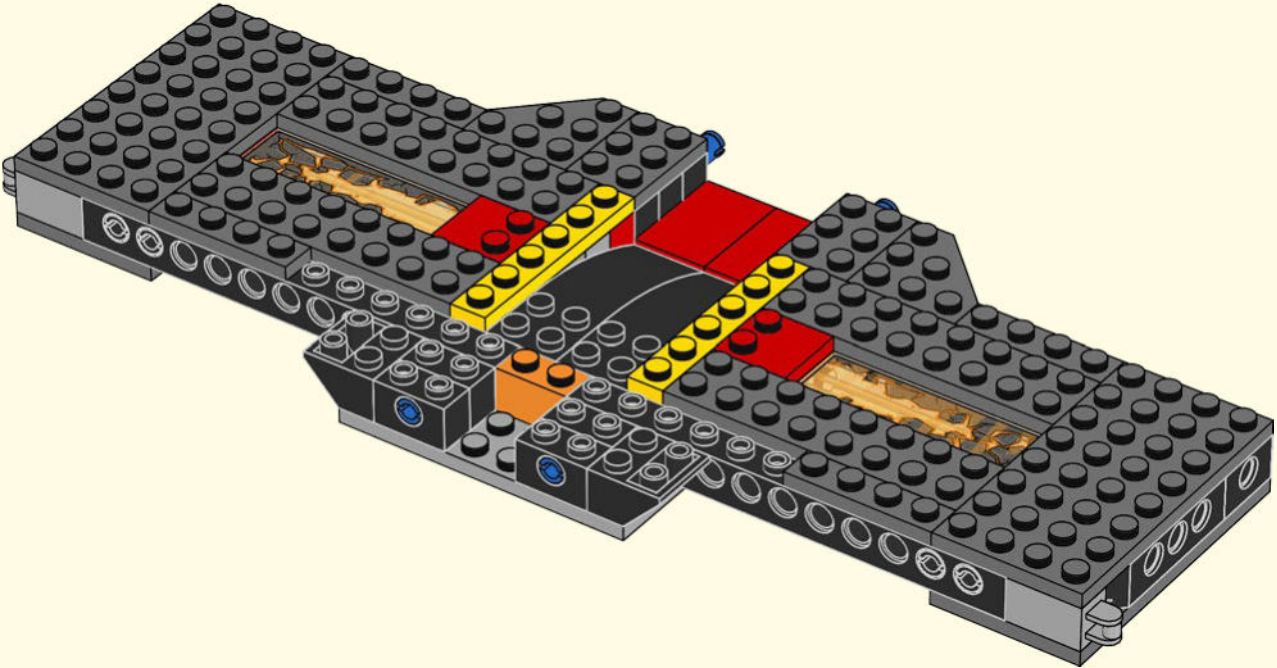





22

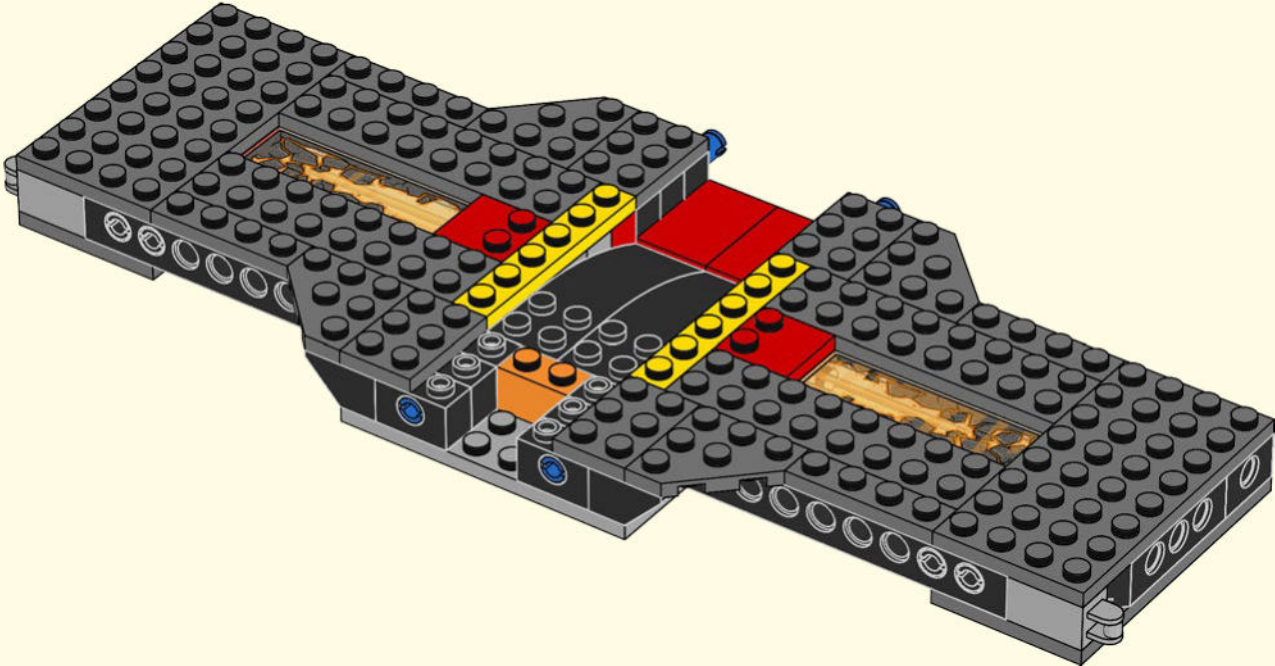



# 23

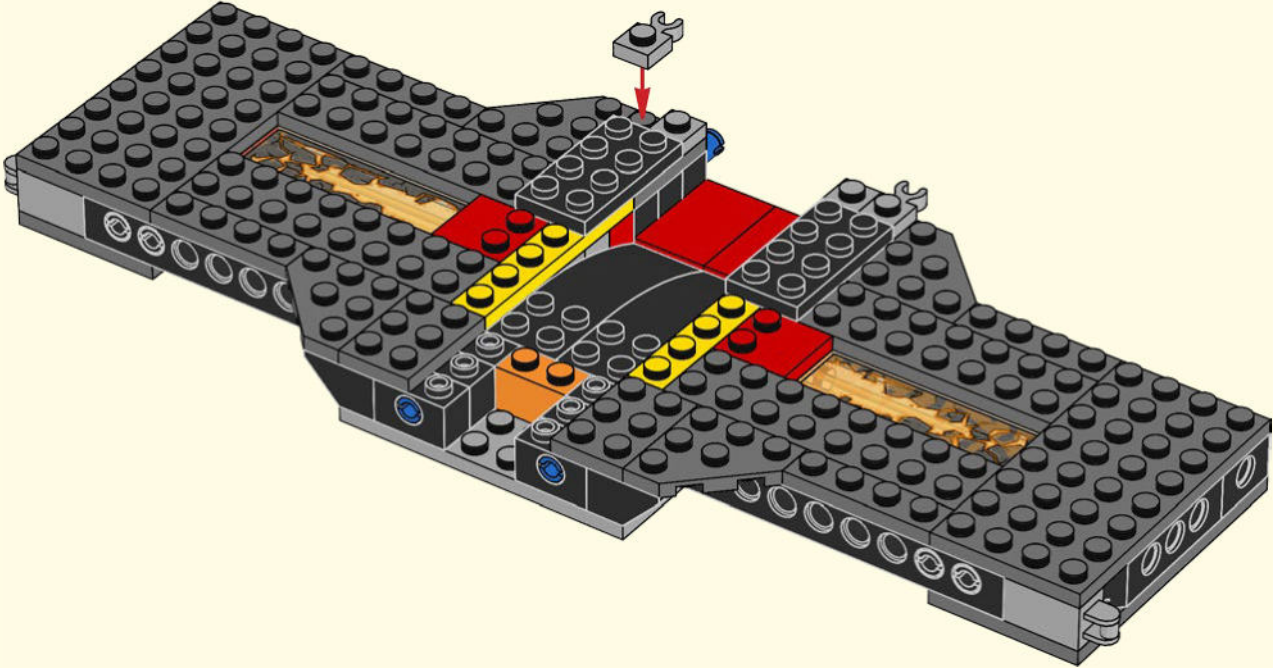



24

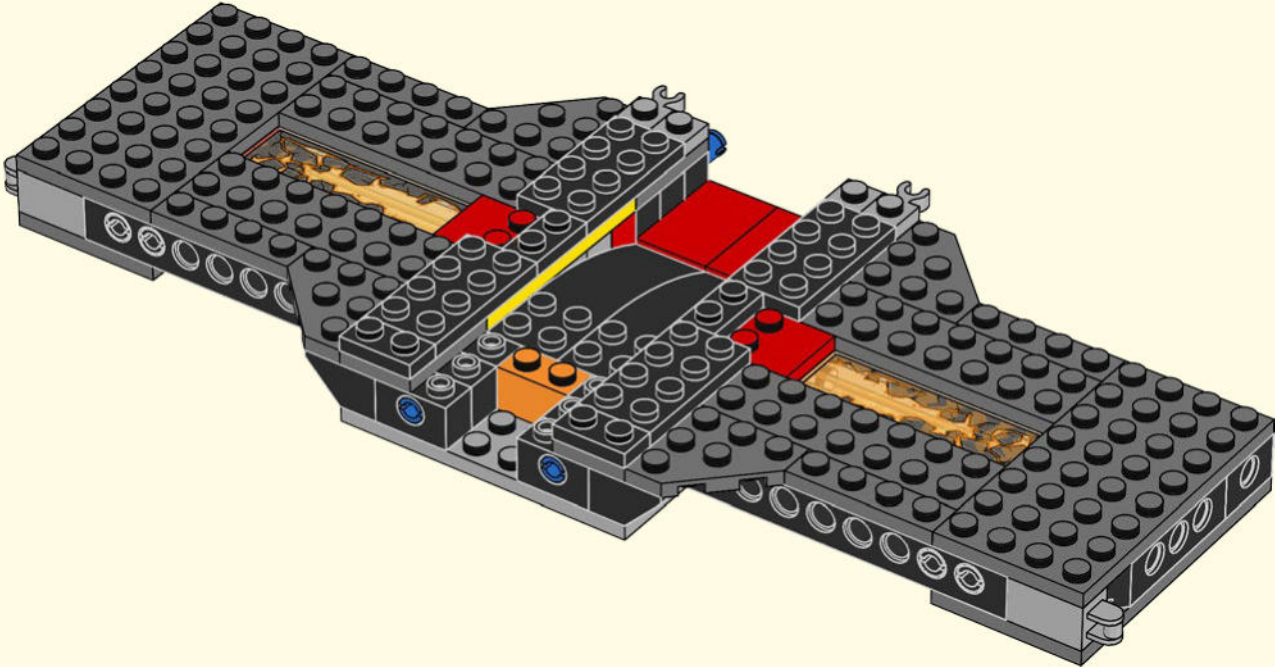

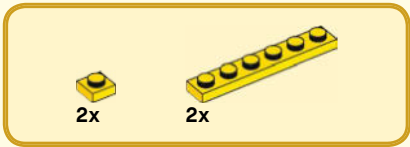

25

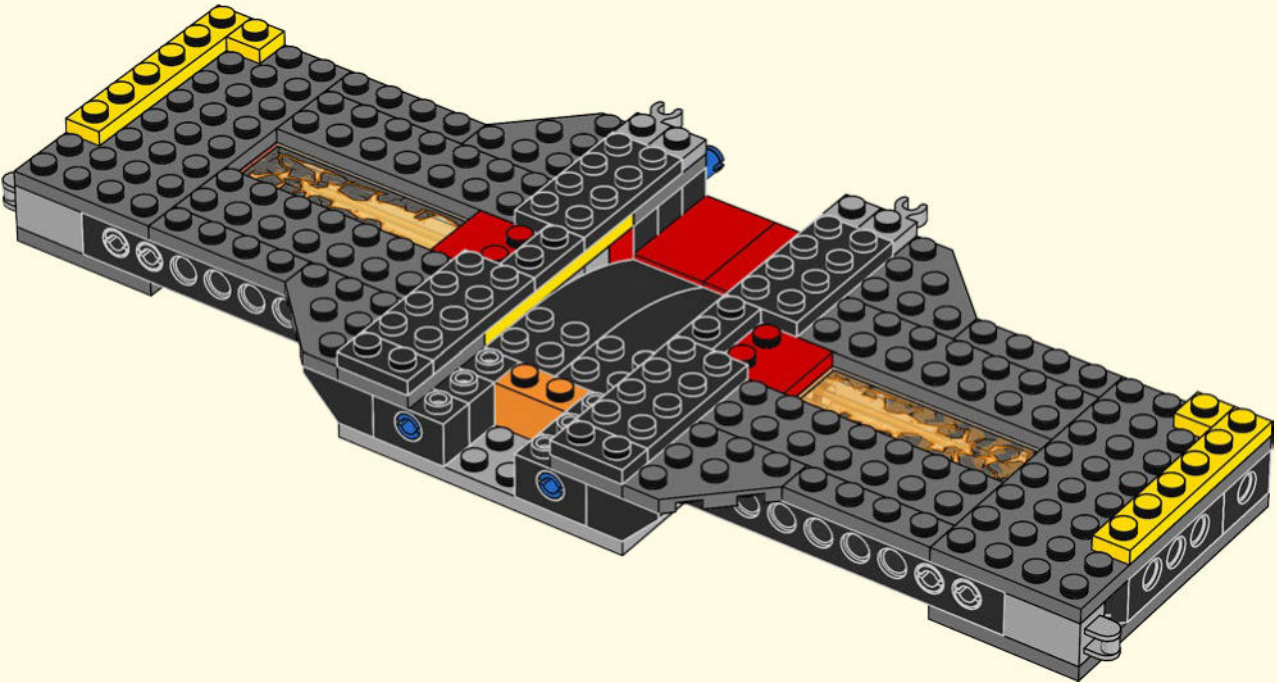



26

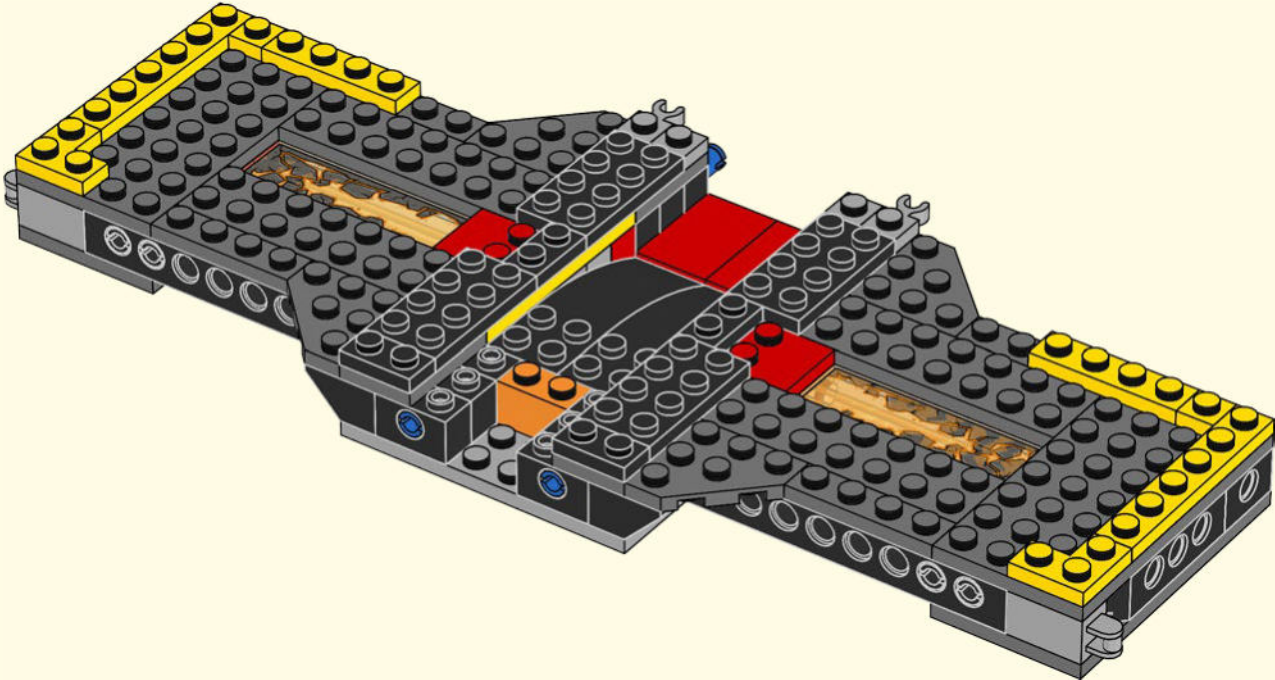

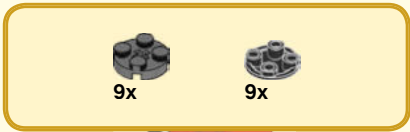

27

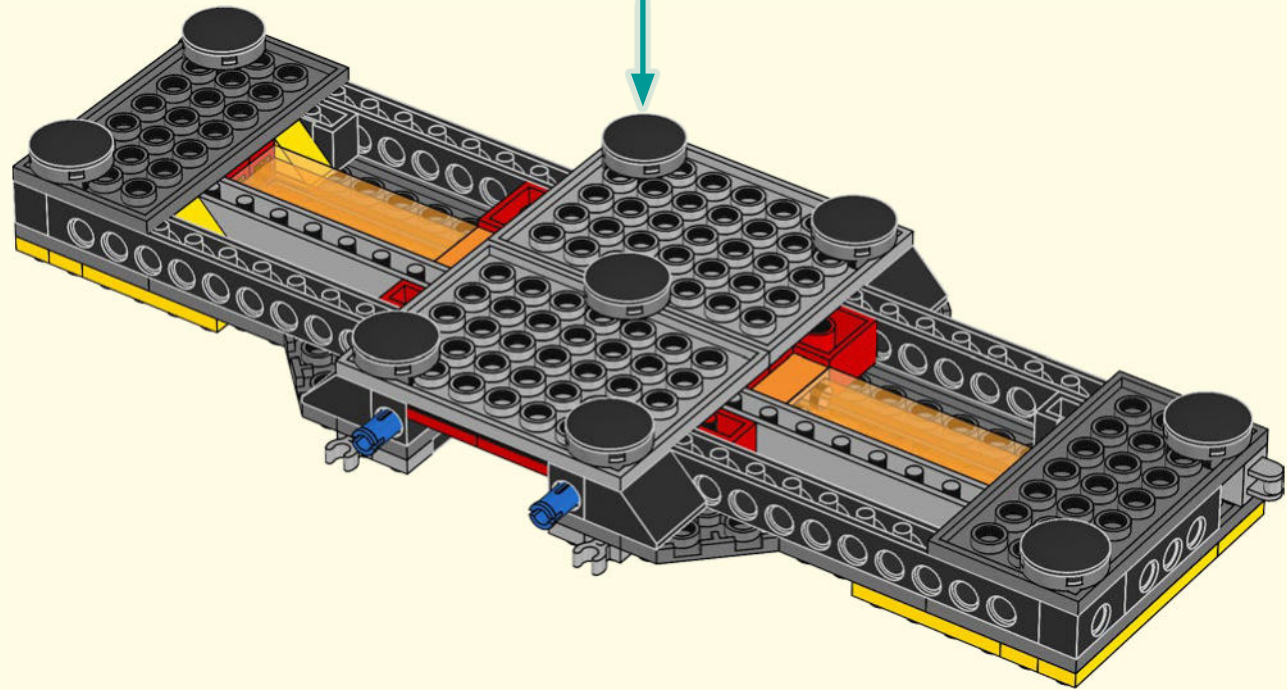
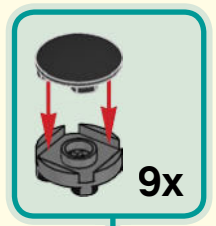

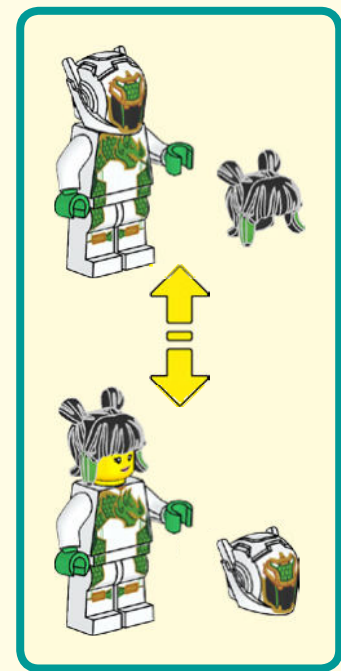
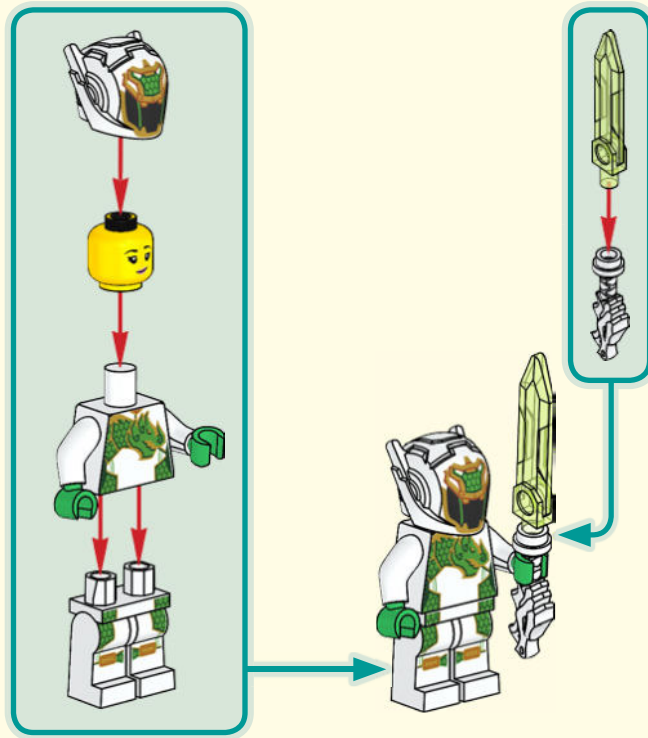
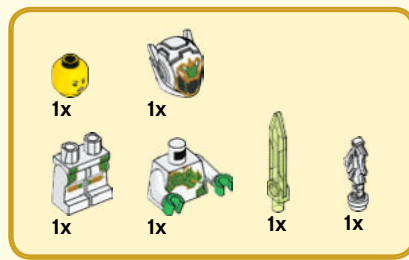



2x



2x

28

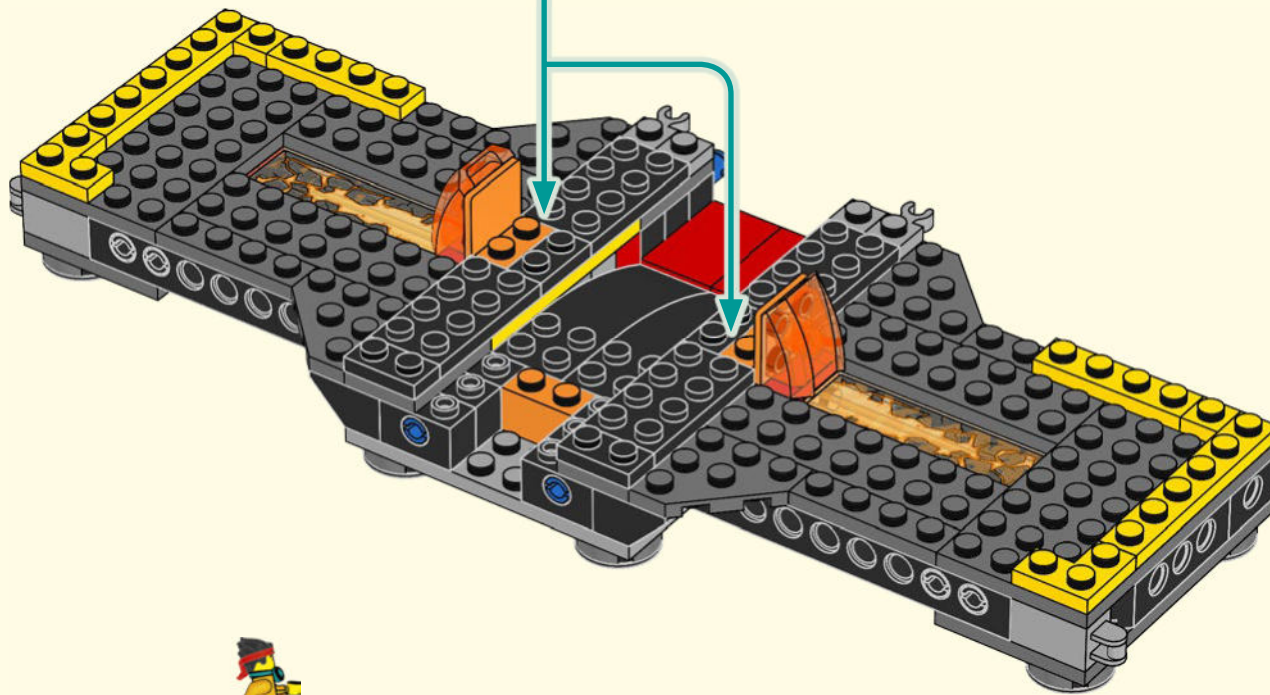
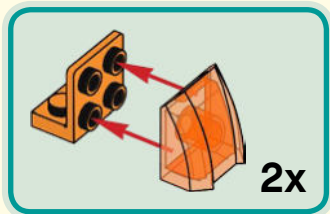



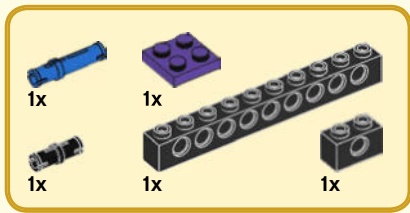

29

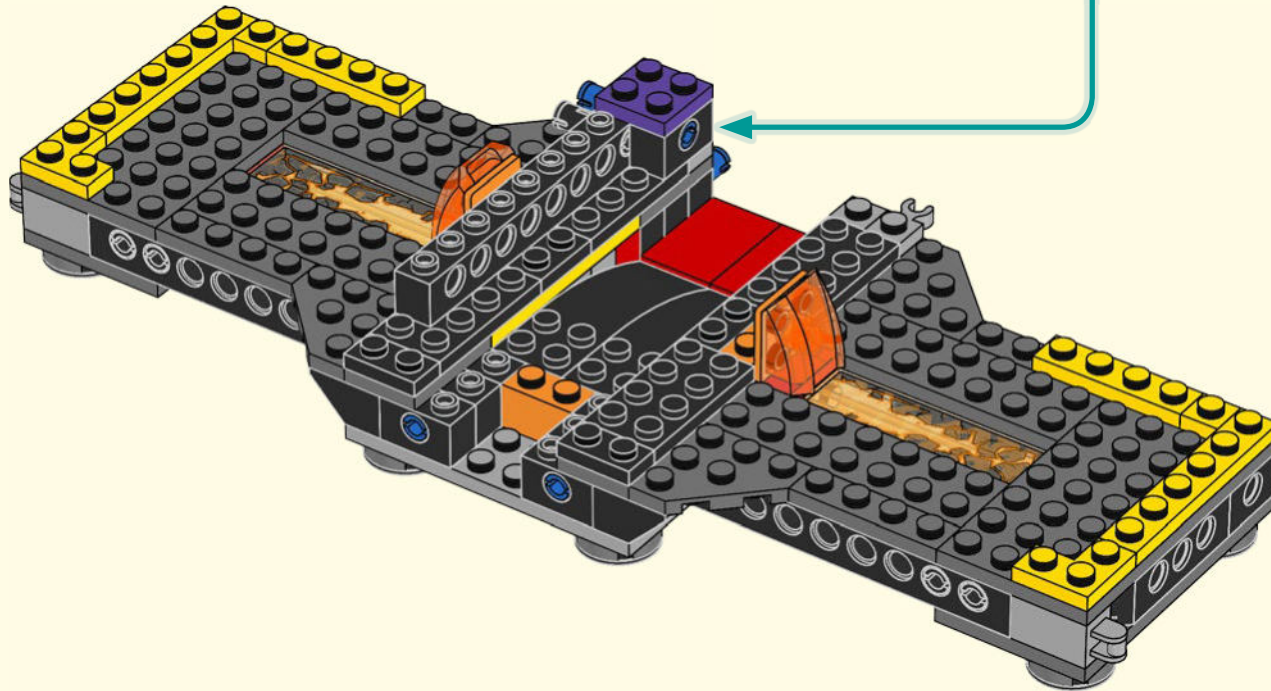
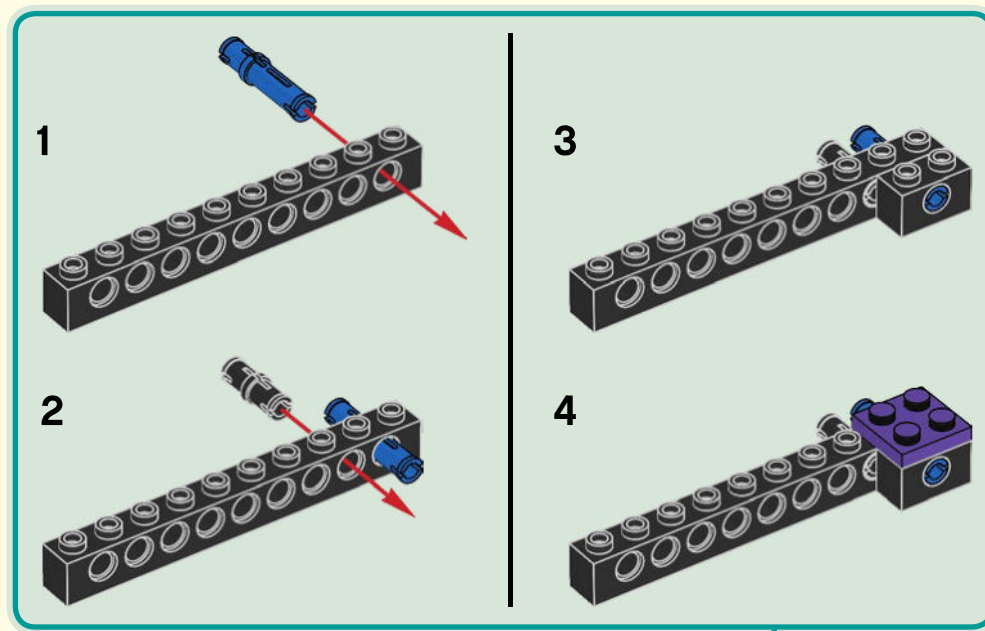

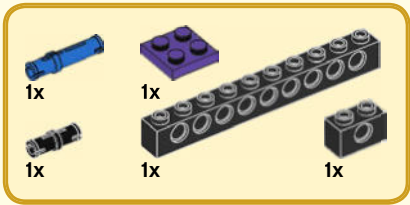

30

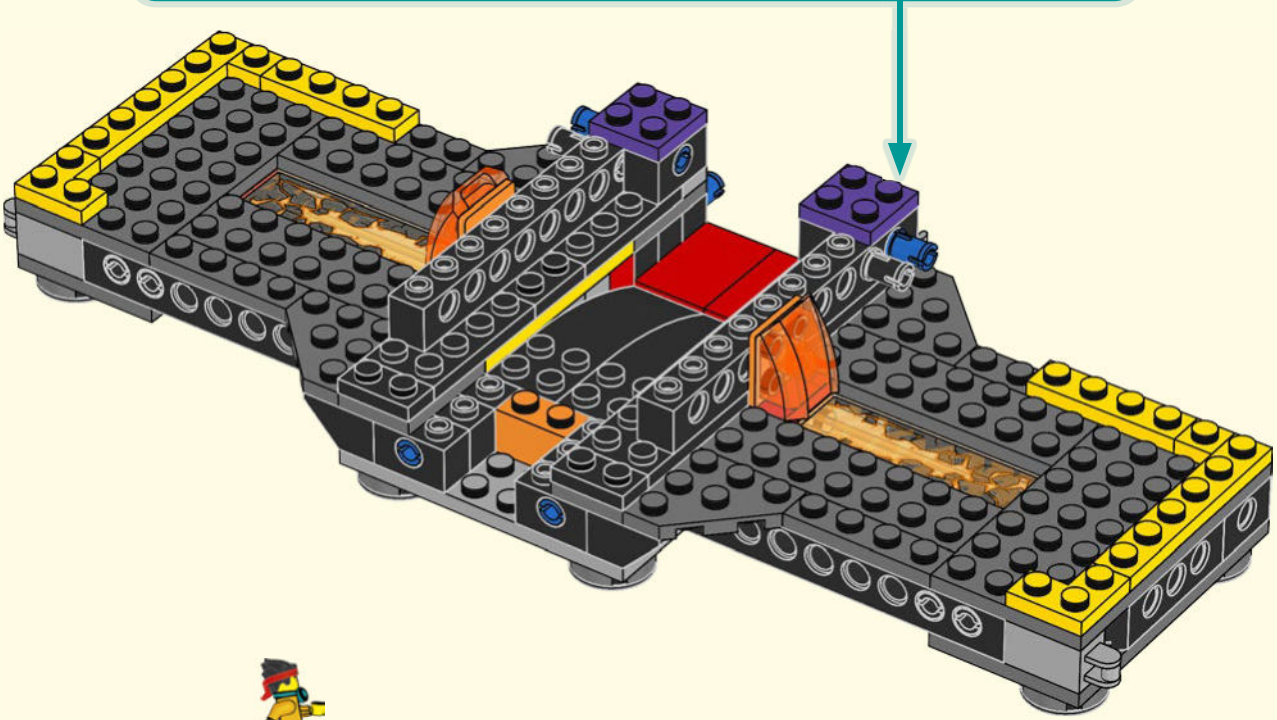
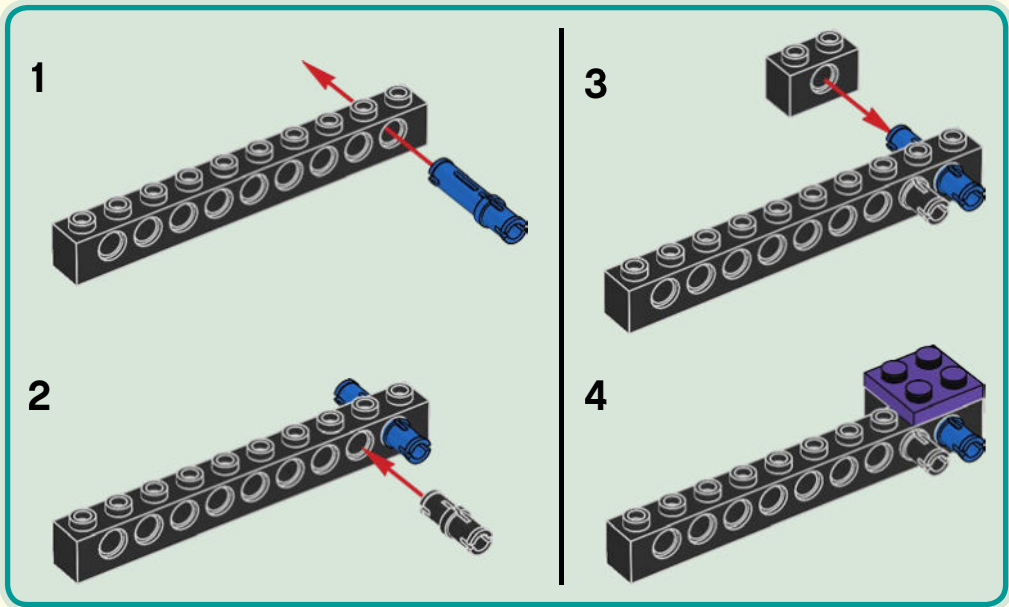



31

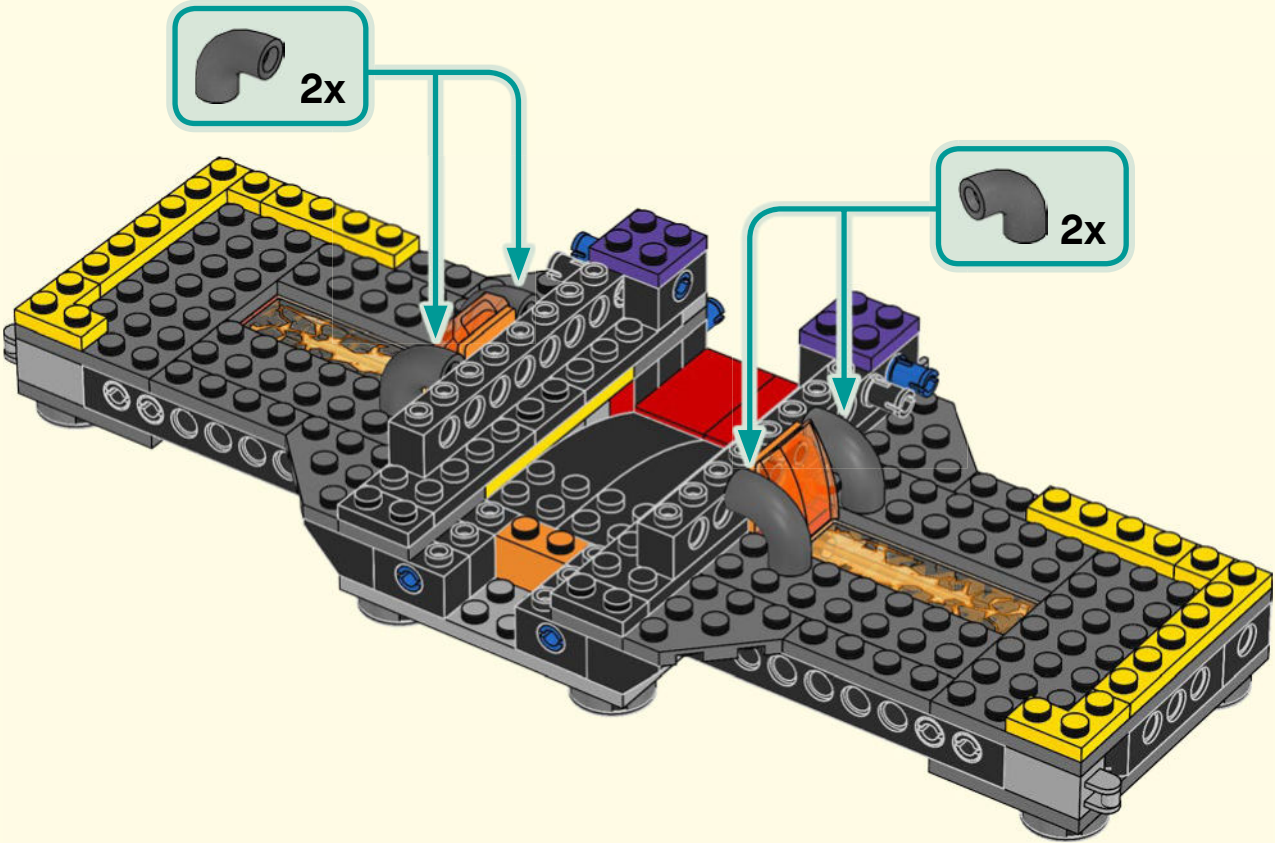

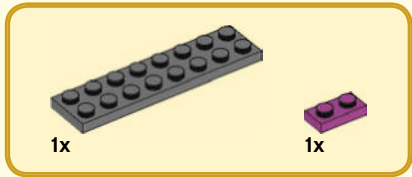
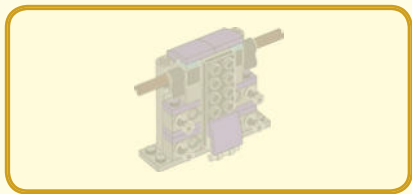

32

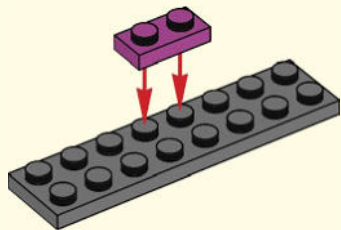

33

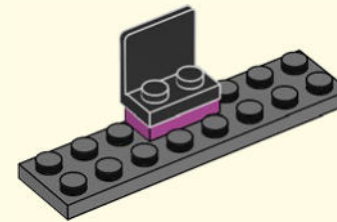

34

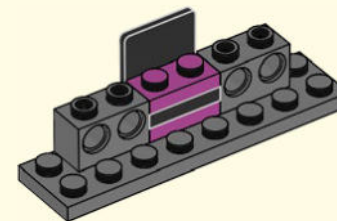

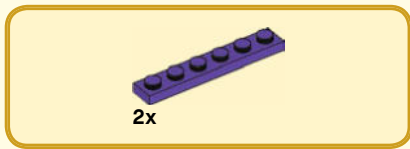

35

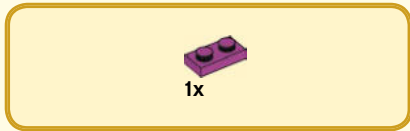
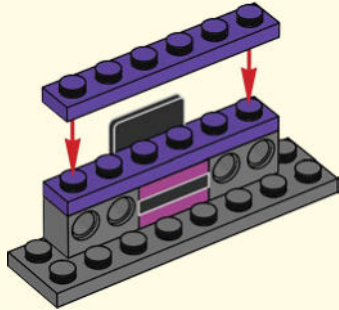

36

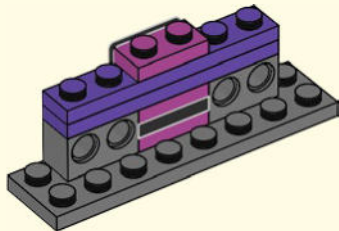

37

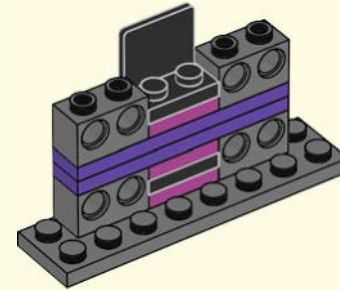

38

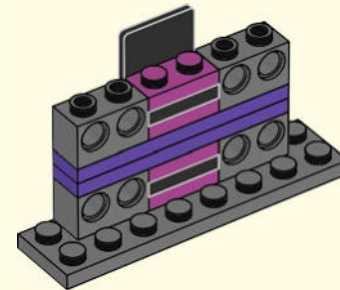

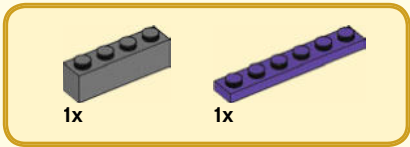

39

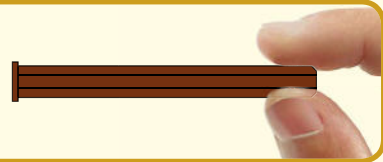
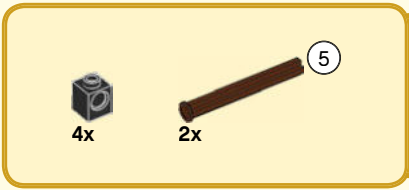
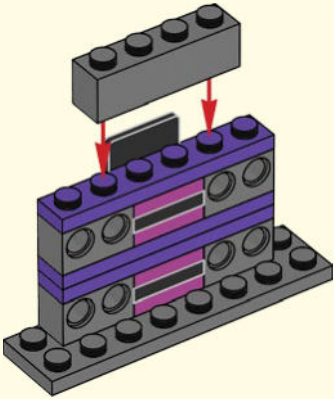

40

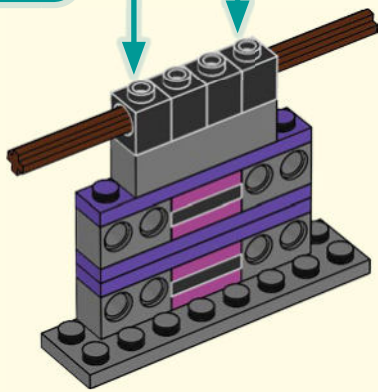
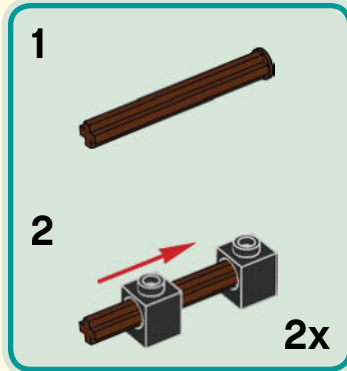

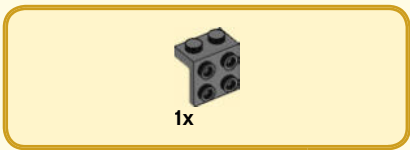

41

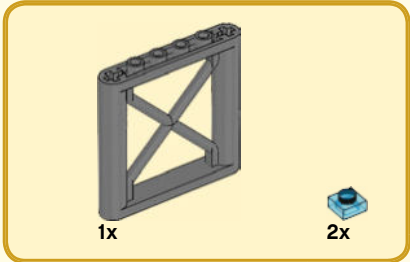
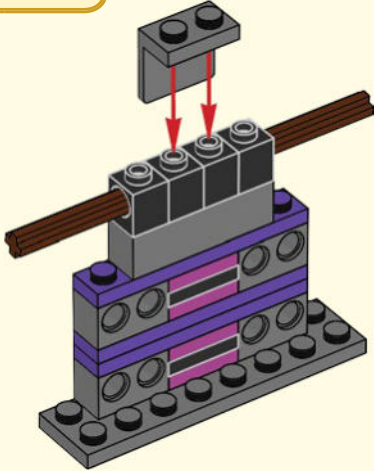

42

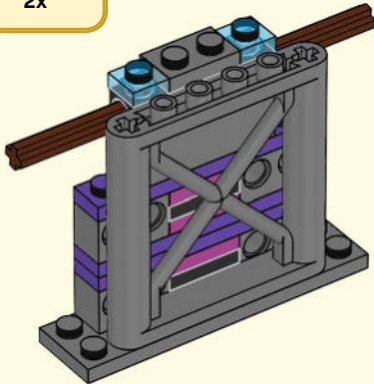

43

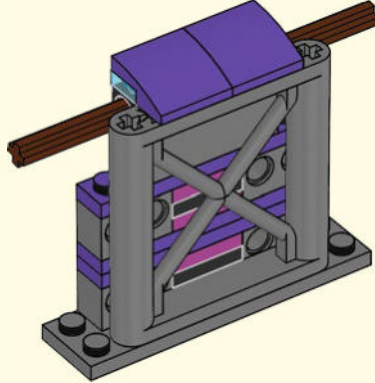

44

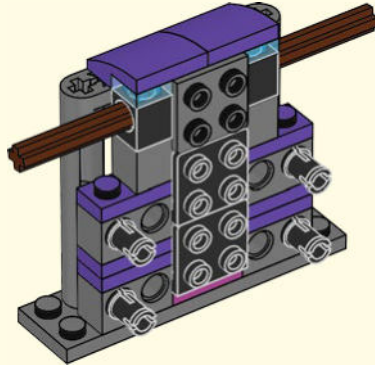



2x

# 45

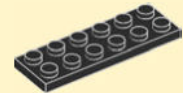
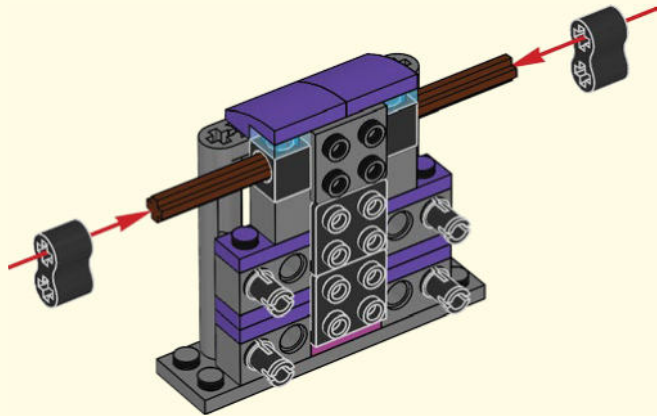

1x



1x



1x

# 46

1

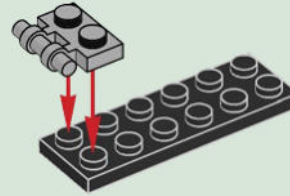

2

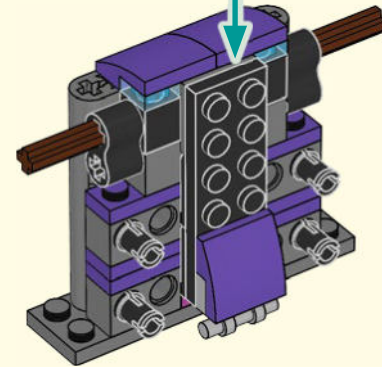
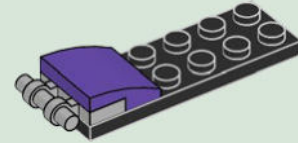



47

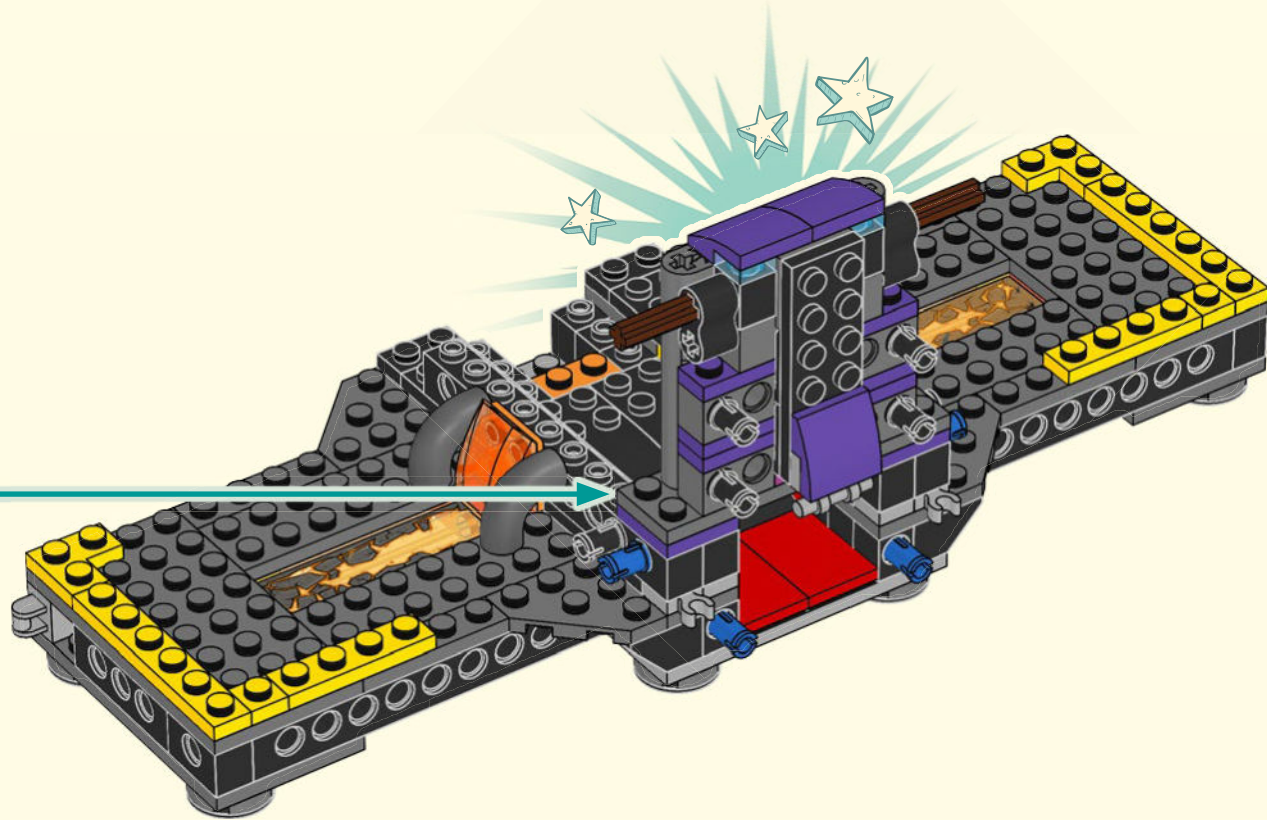

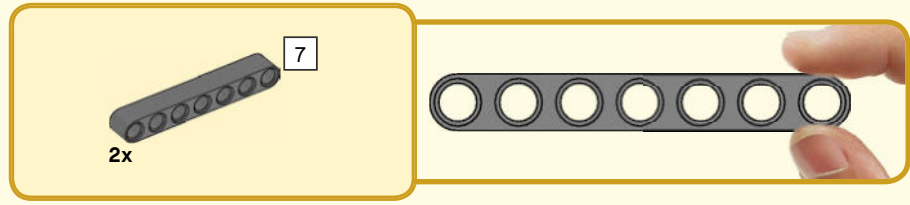

48

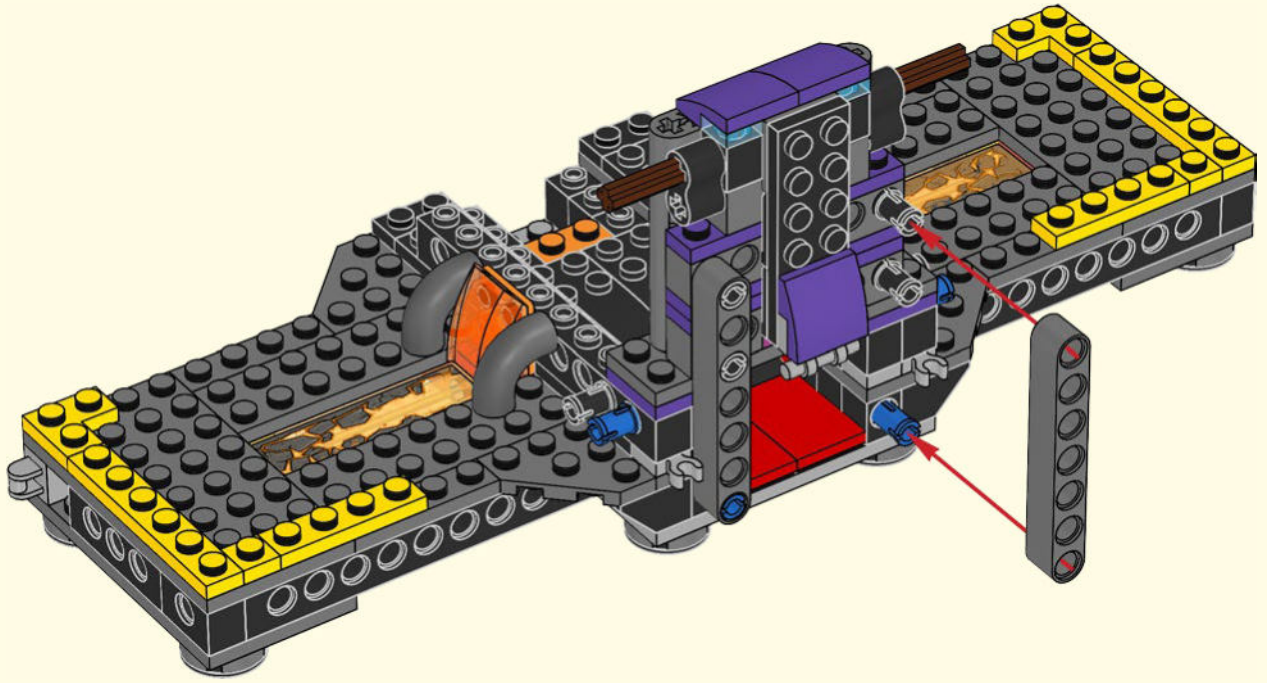



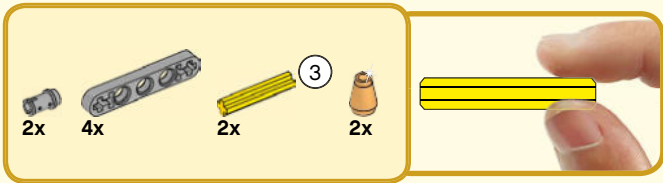

# 50

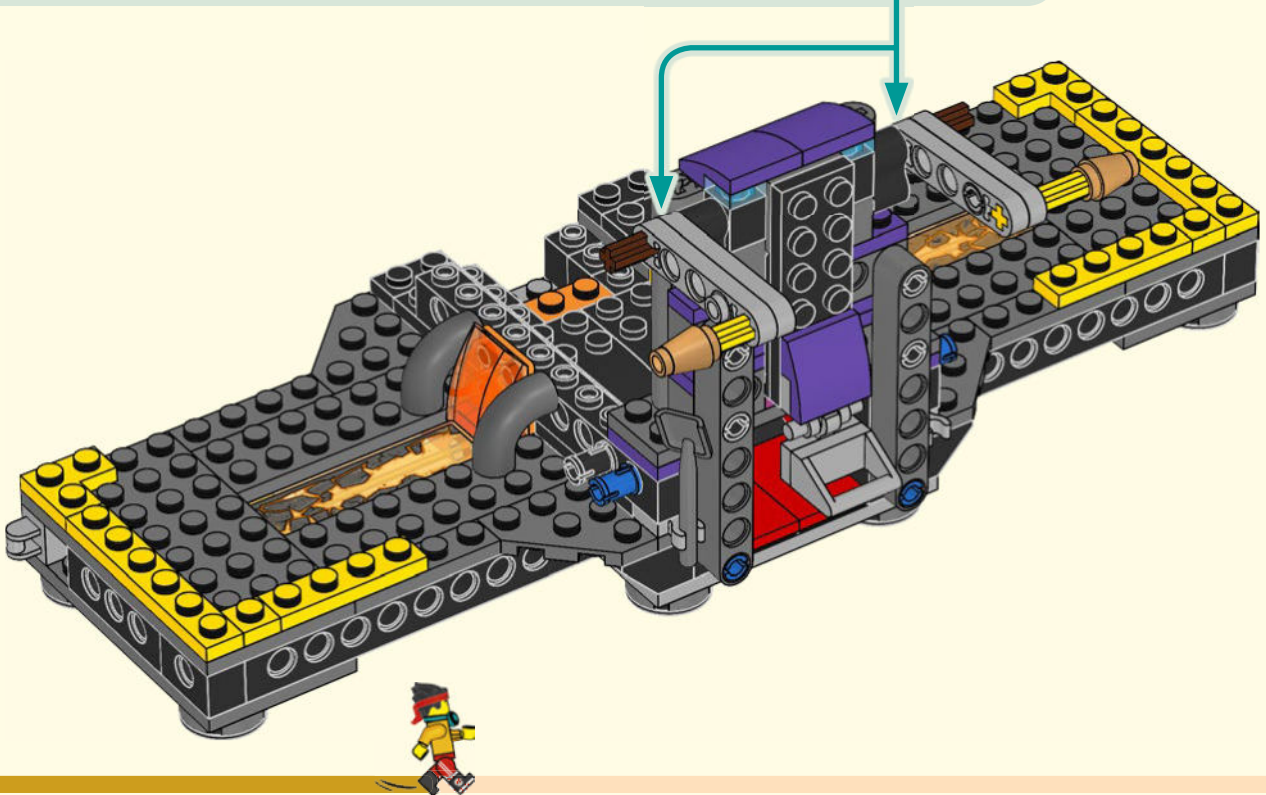
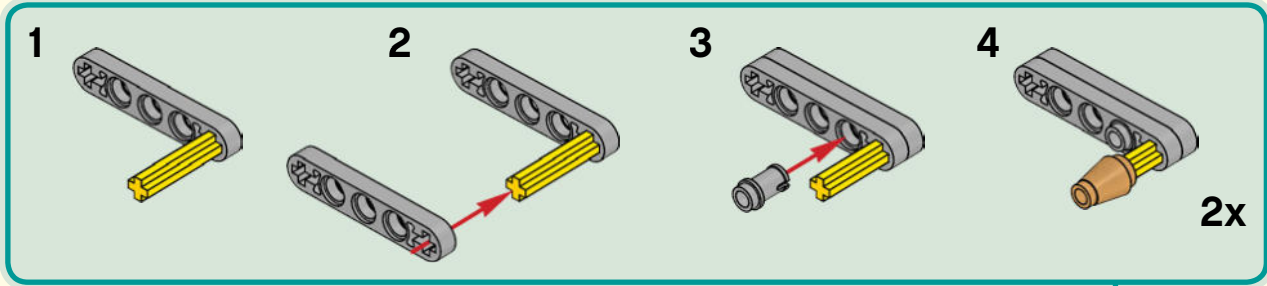



2x

51



2x

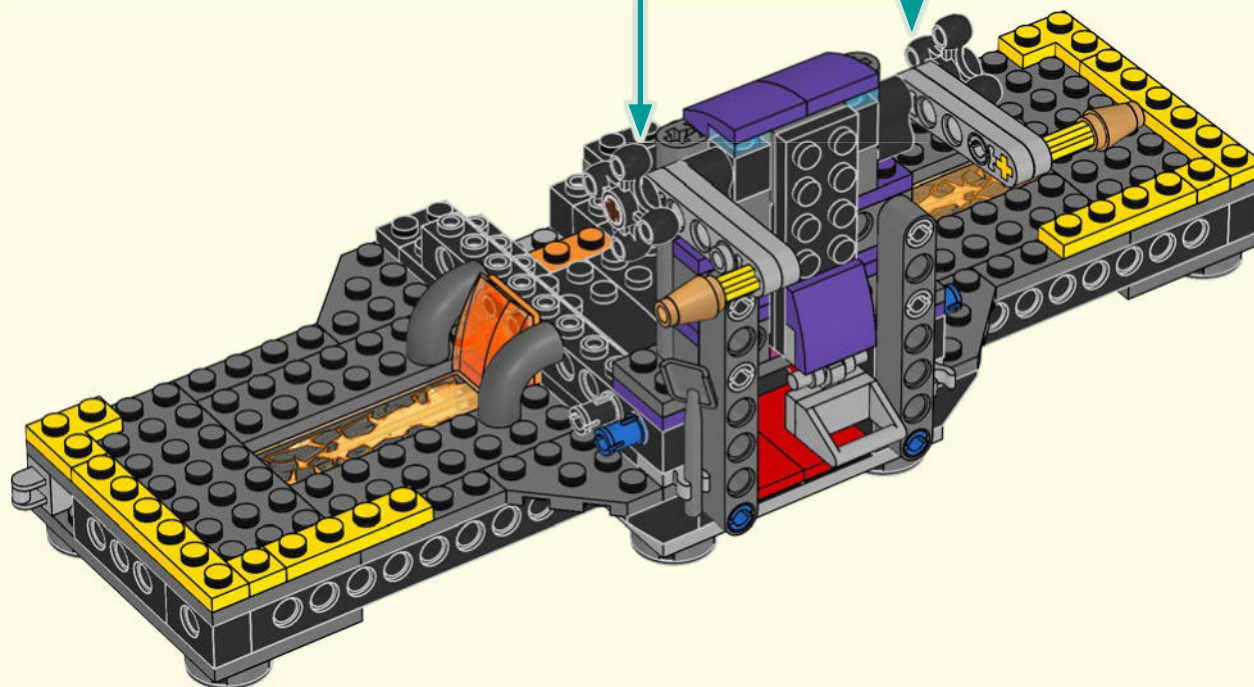

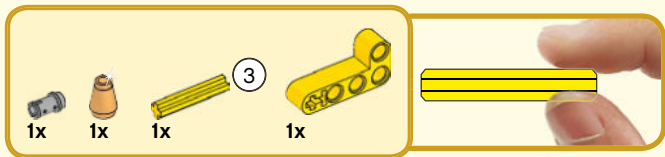

52

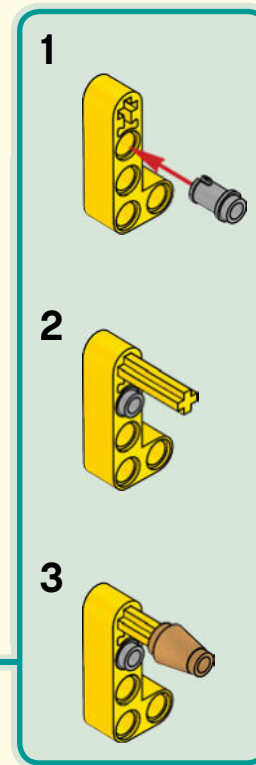
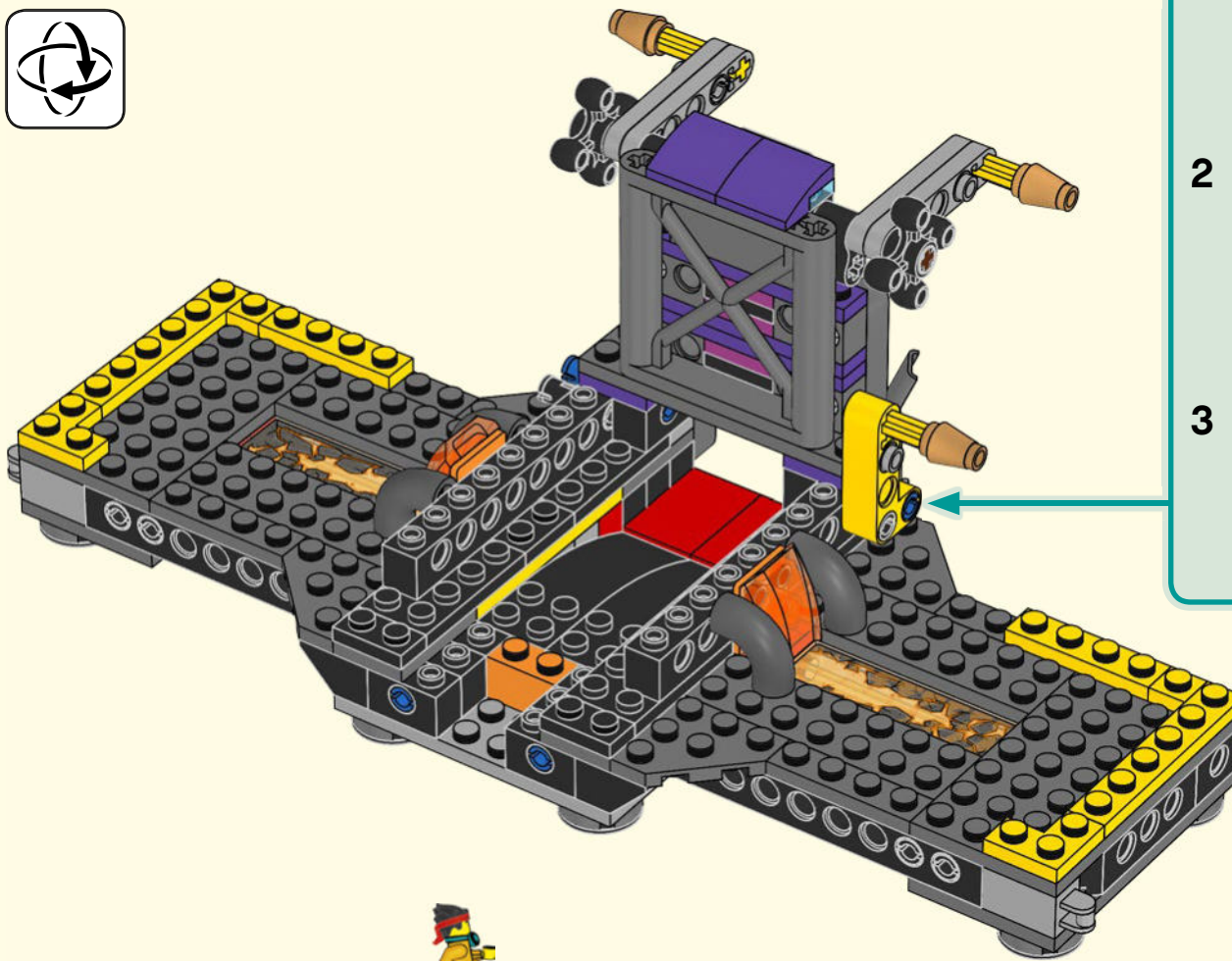

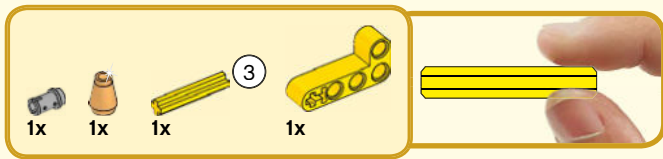

53

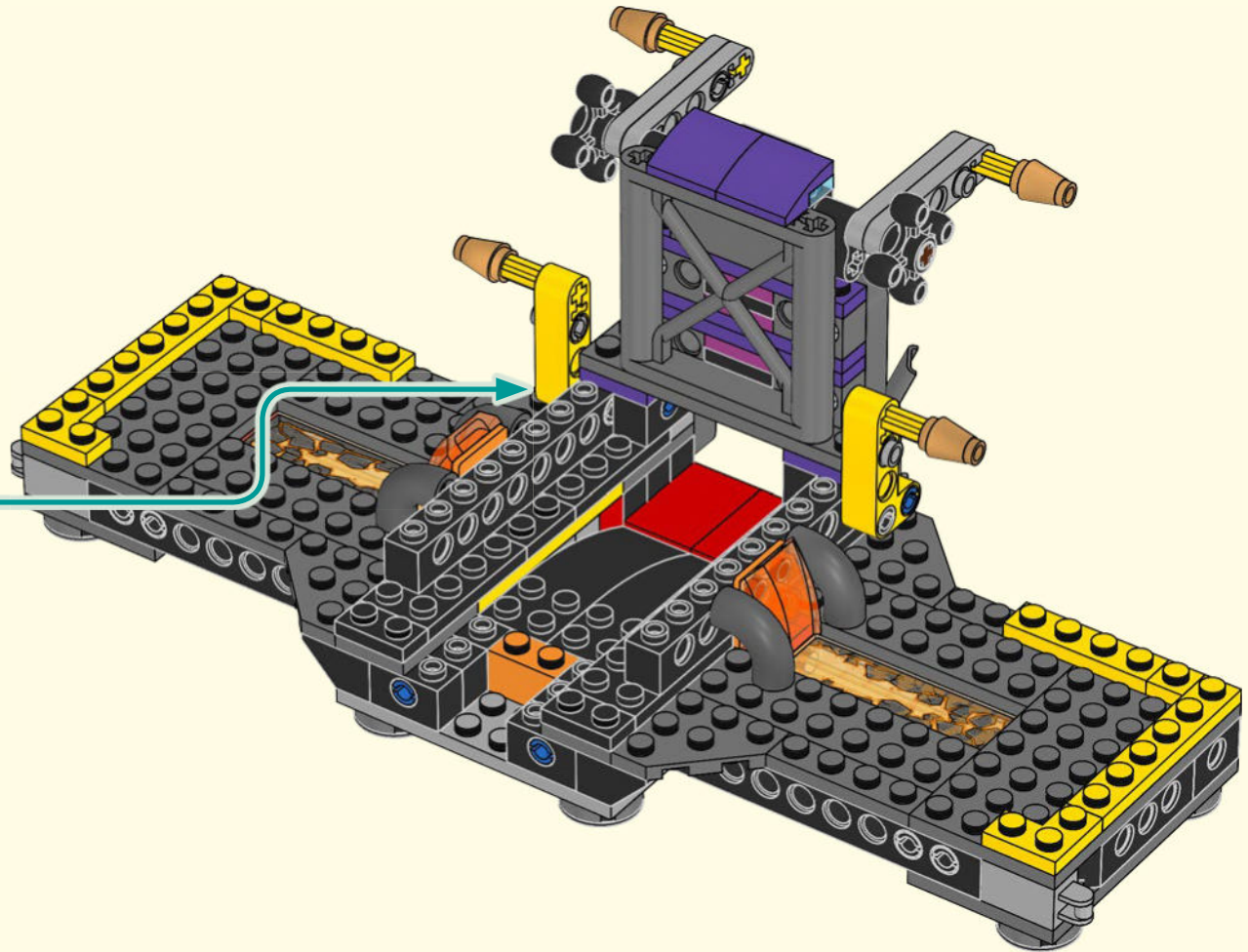
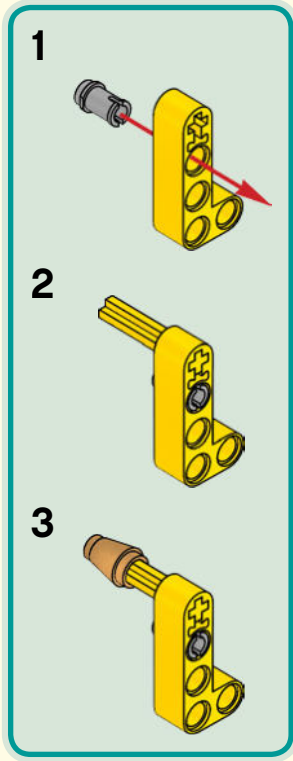

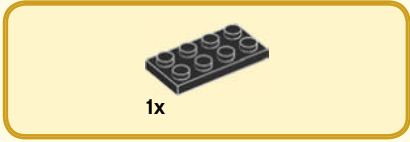
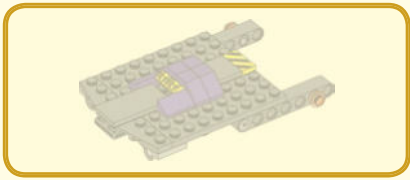

1x

54

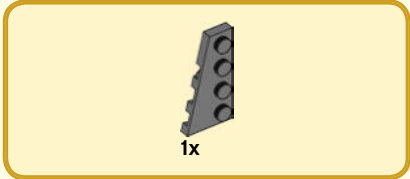
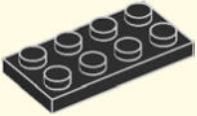

1x

55

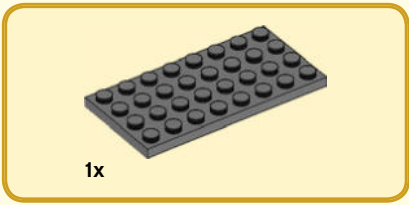
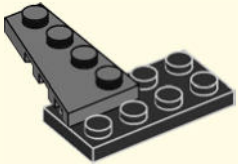

1x

56

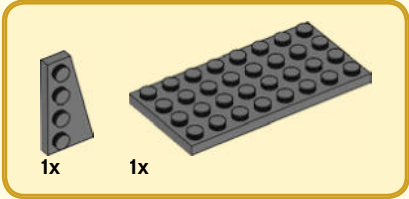
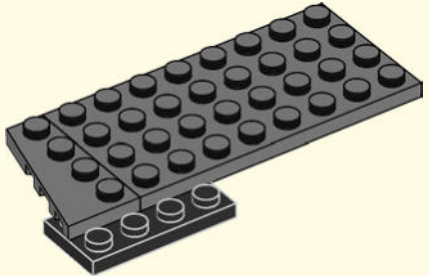

1x

1x

57

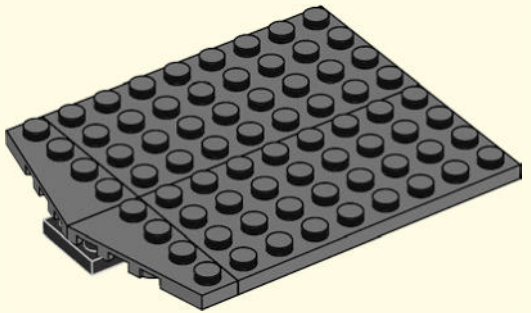



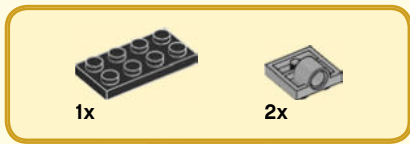

58

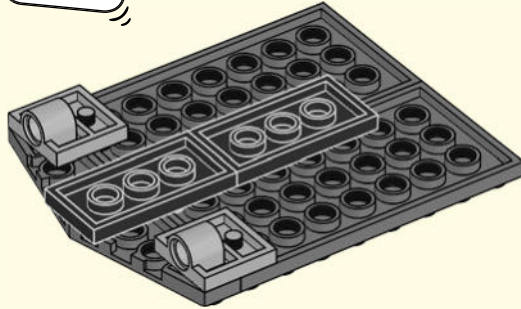

59

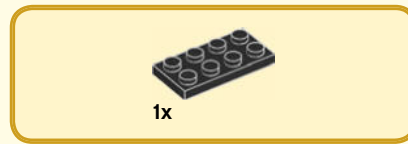
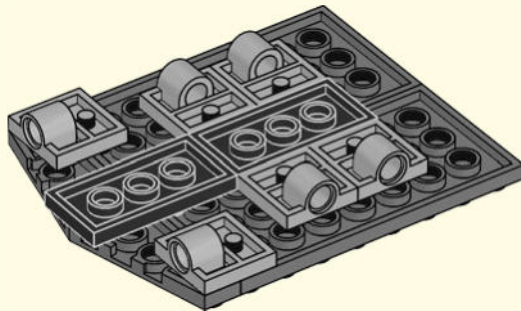

60

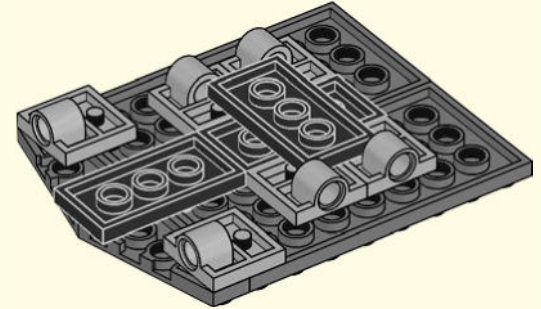

61

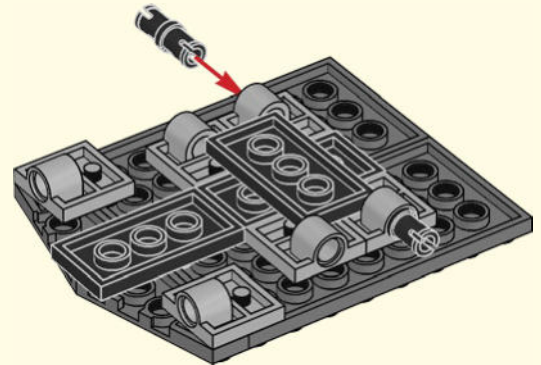

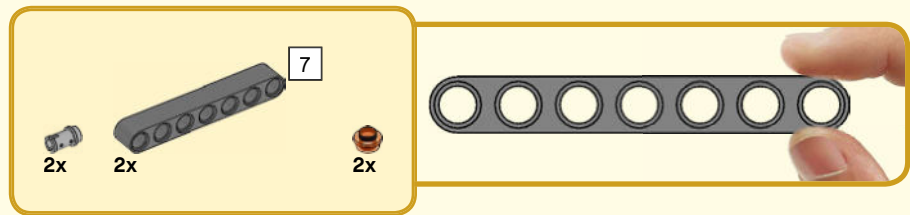

62

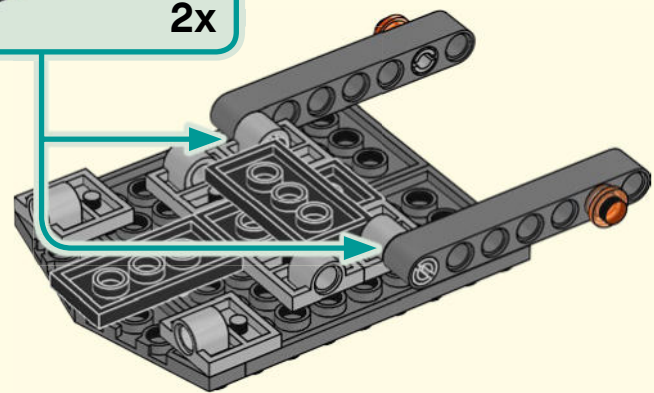
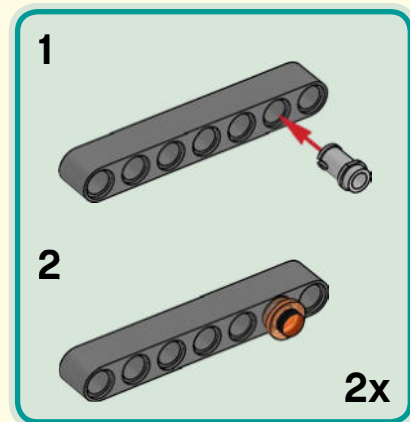

63

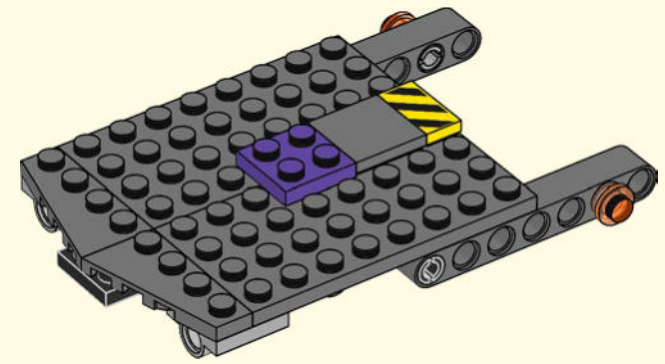
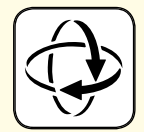



64

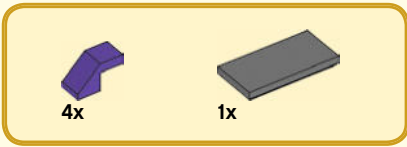
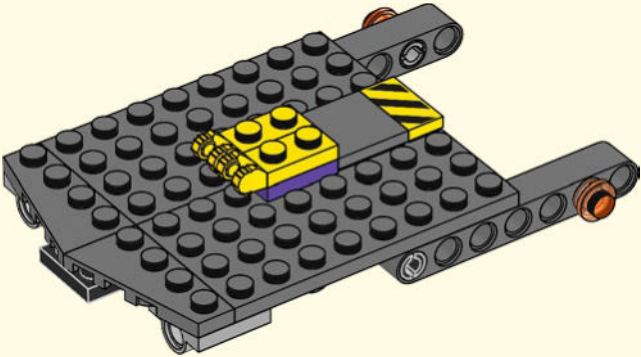

65

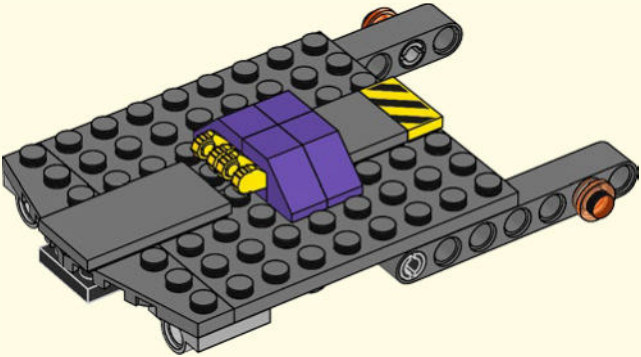



2x

66

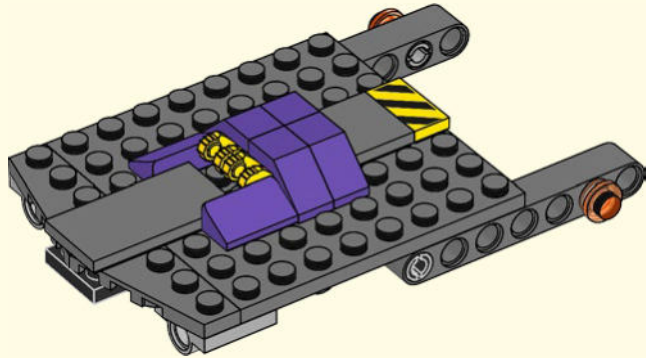

67

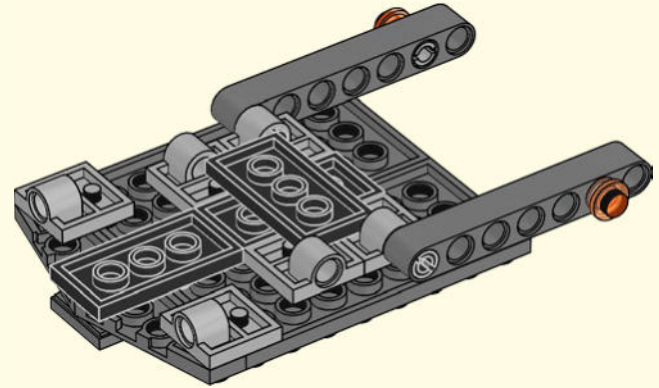
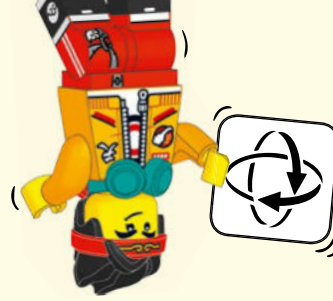



69

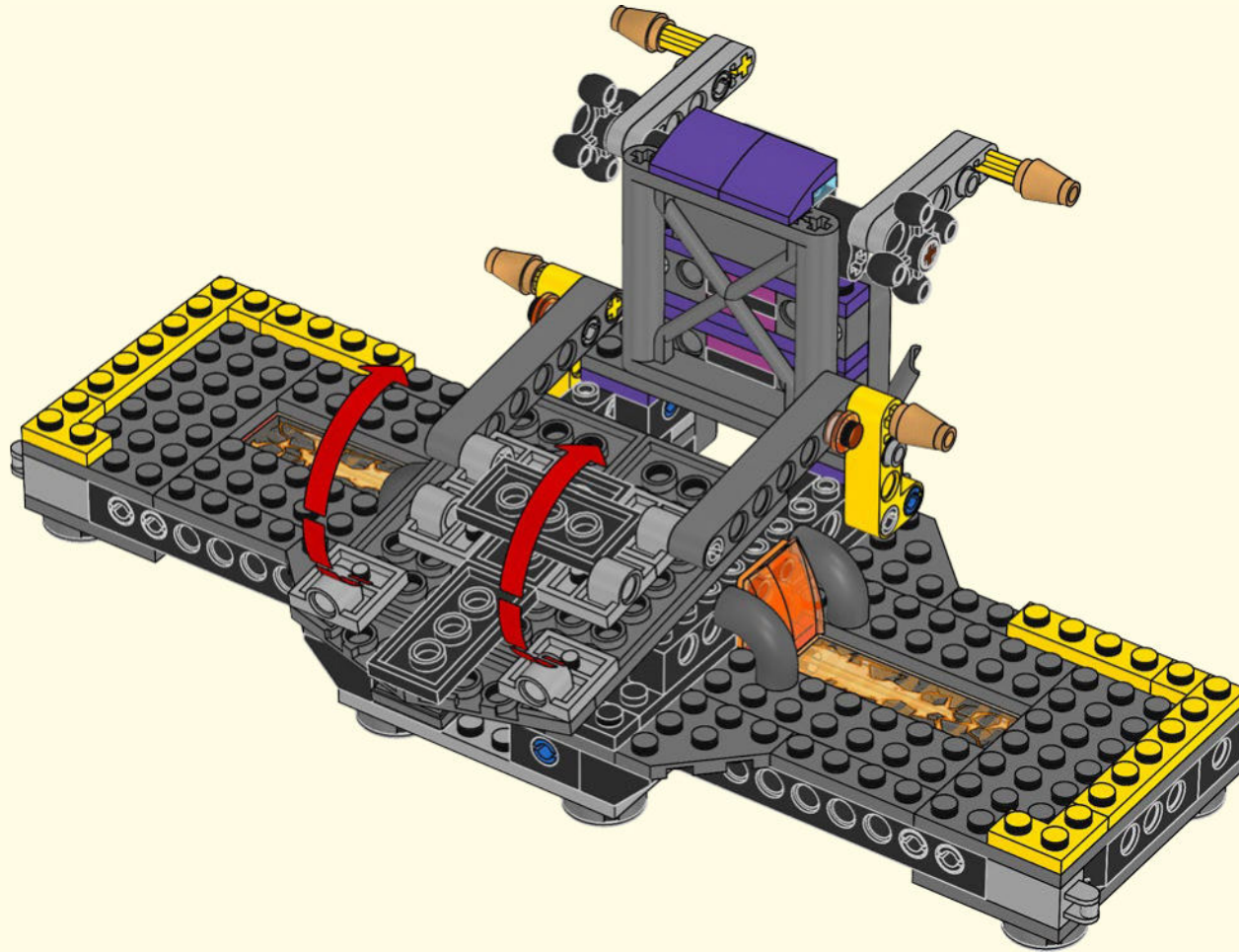



70

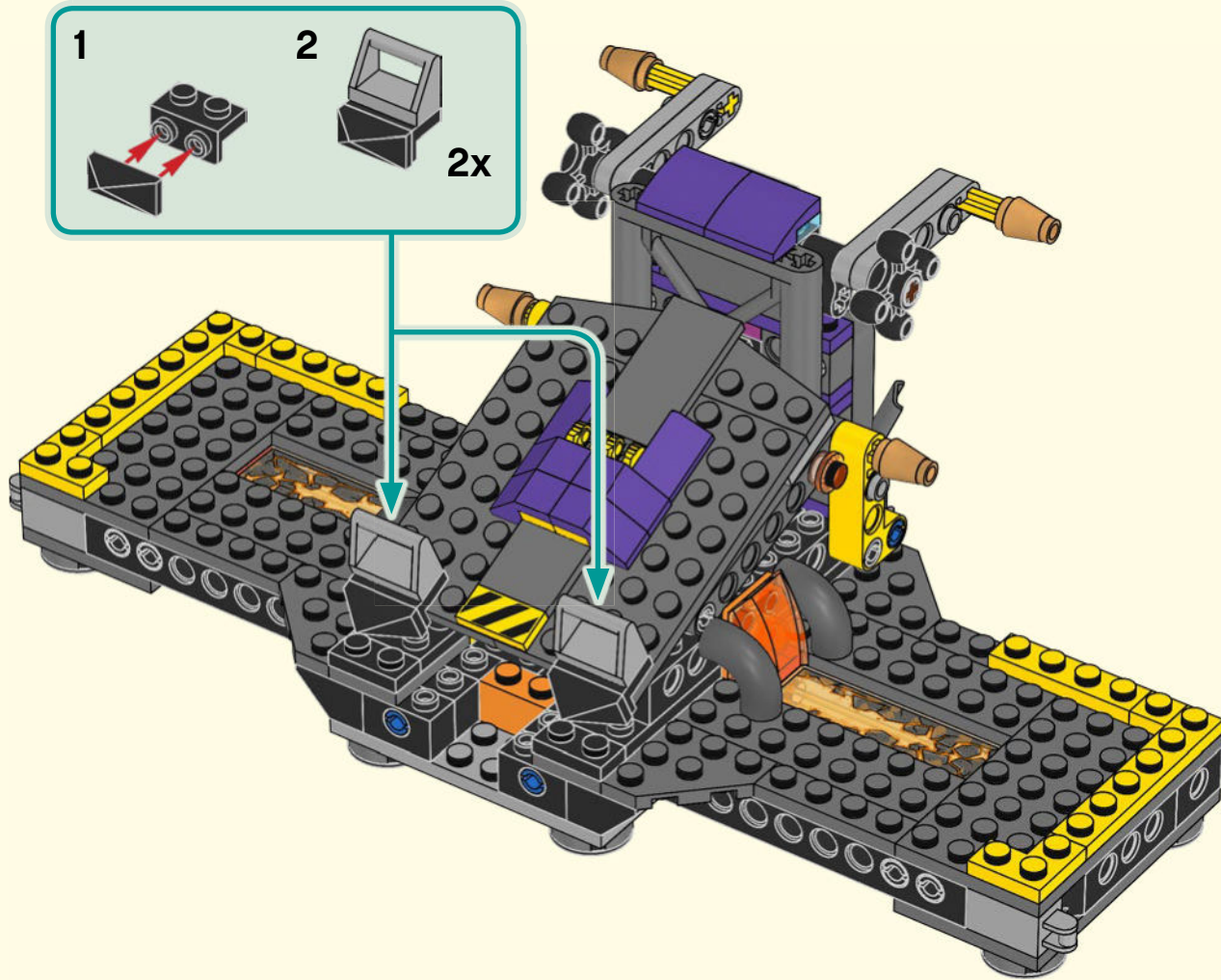

71

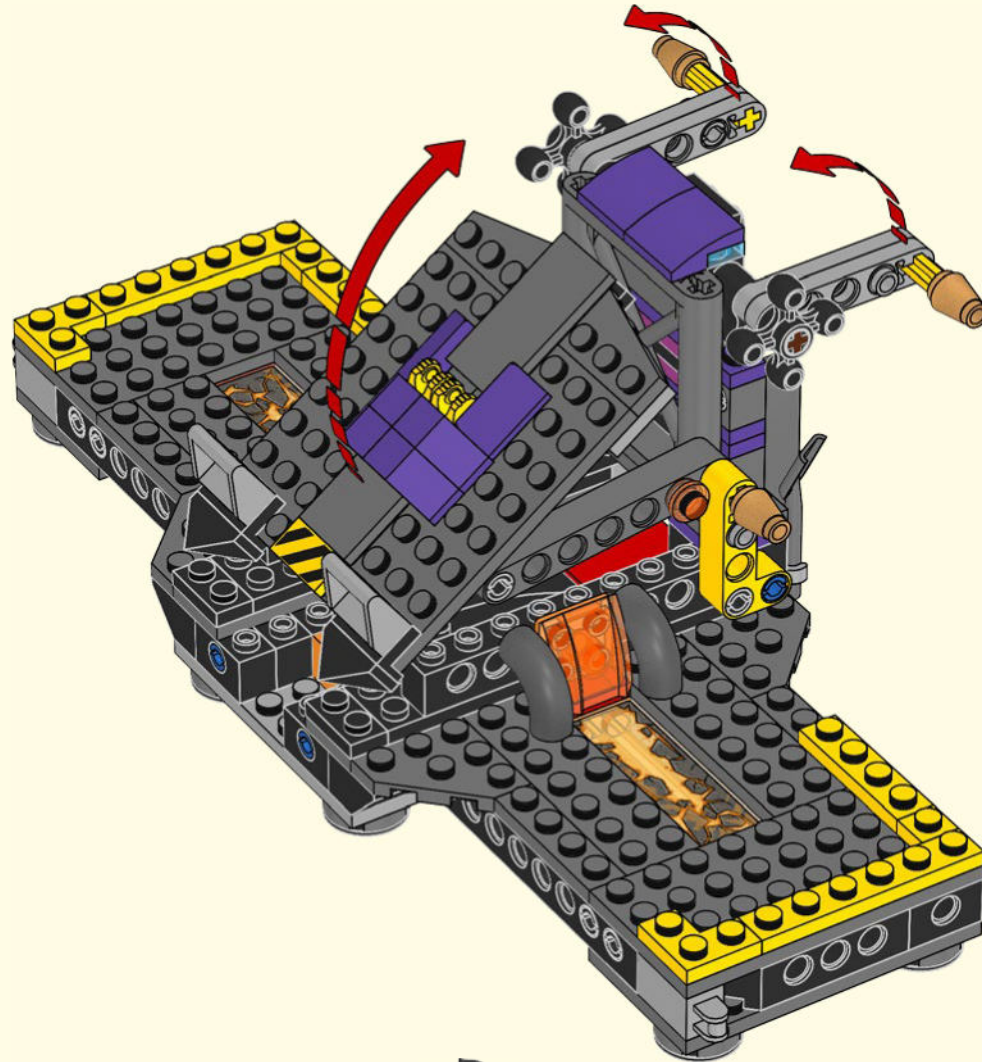



72

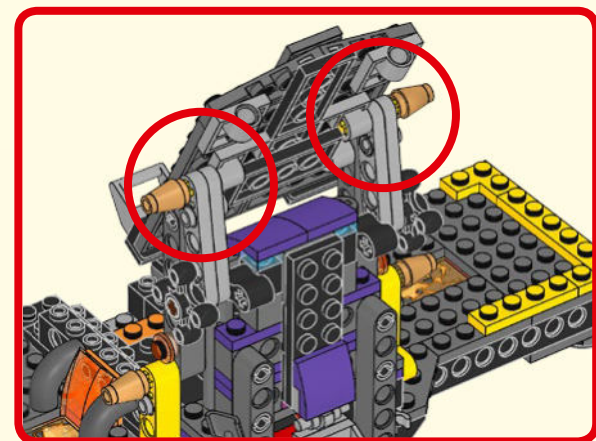
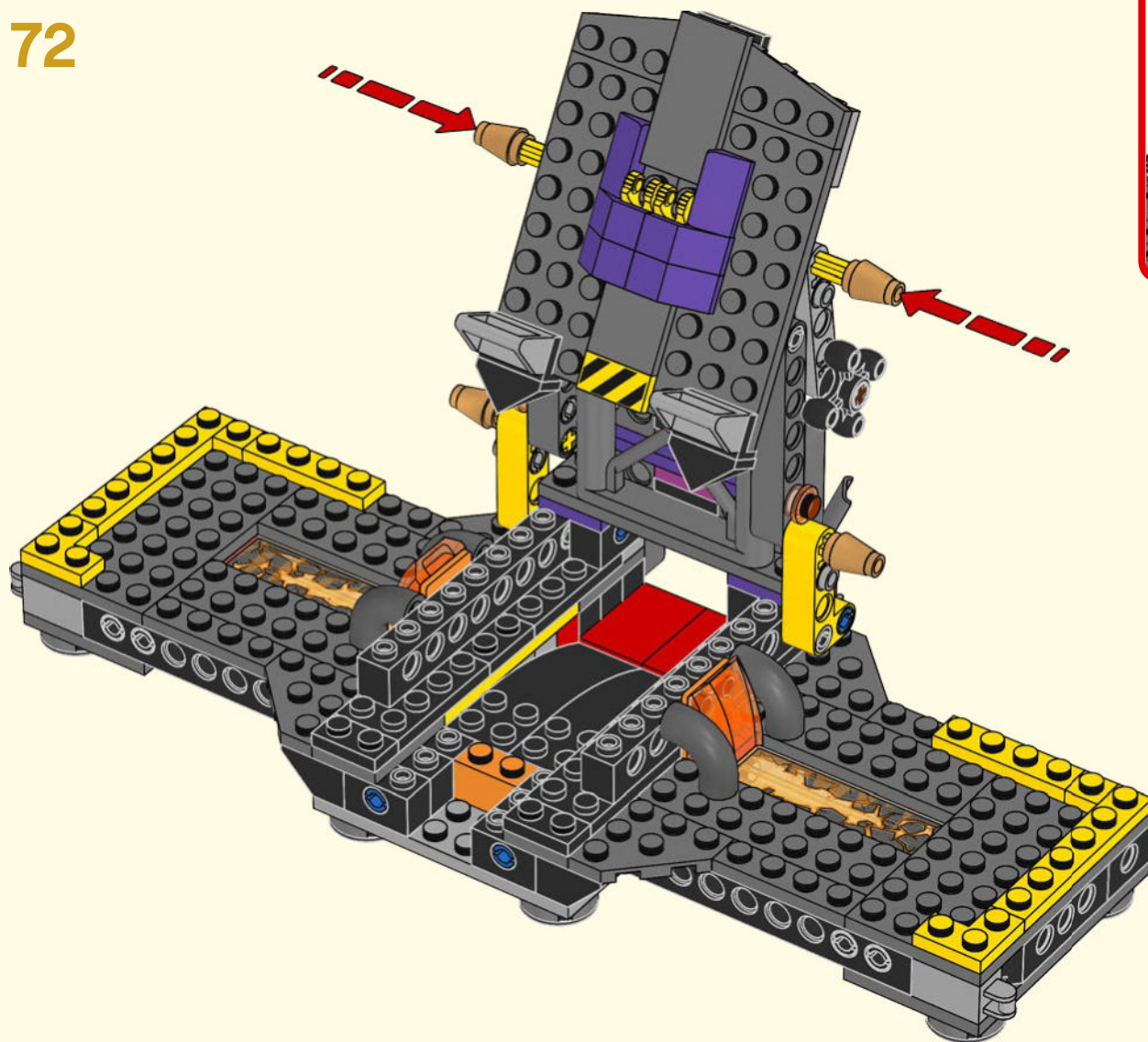





3x

73

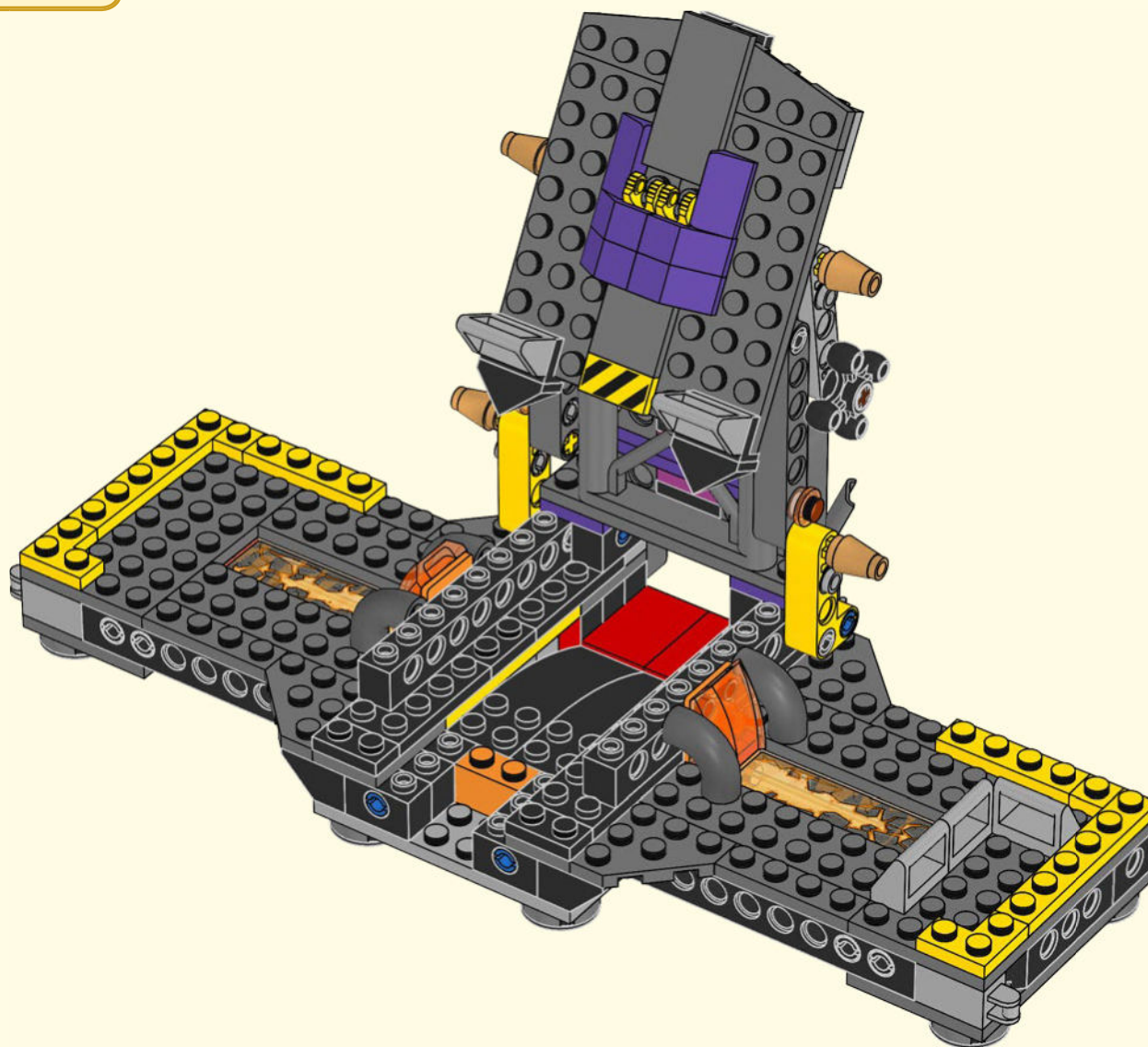

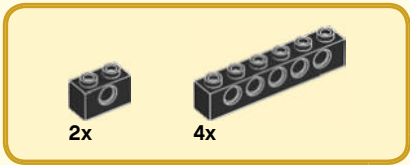

74

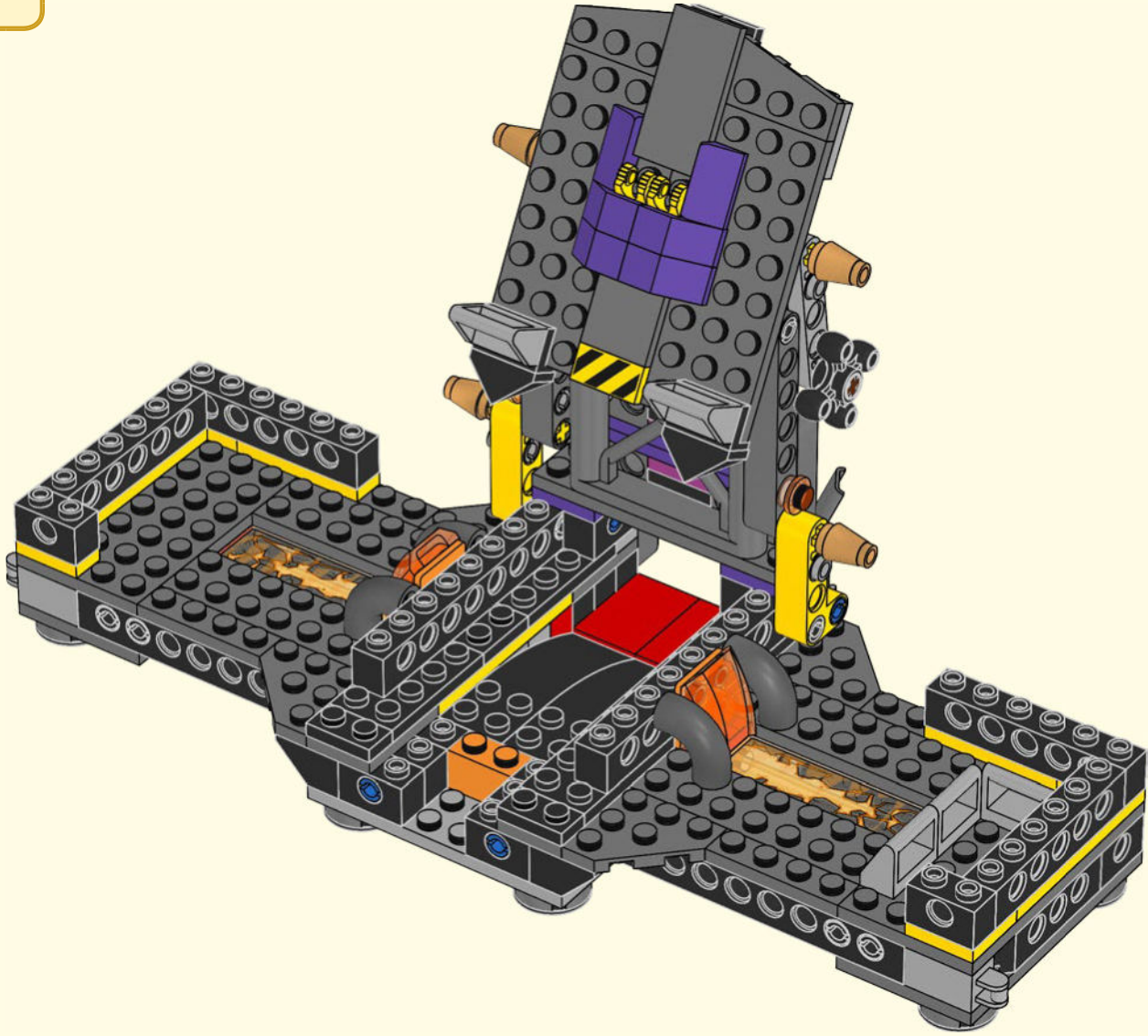

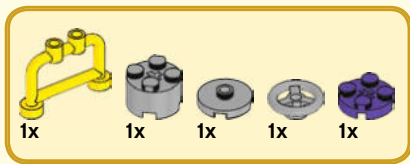

75

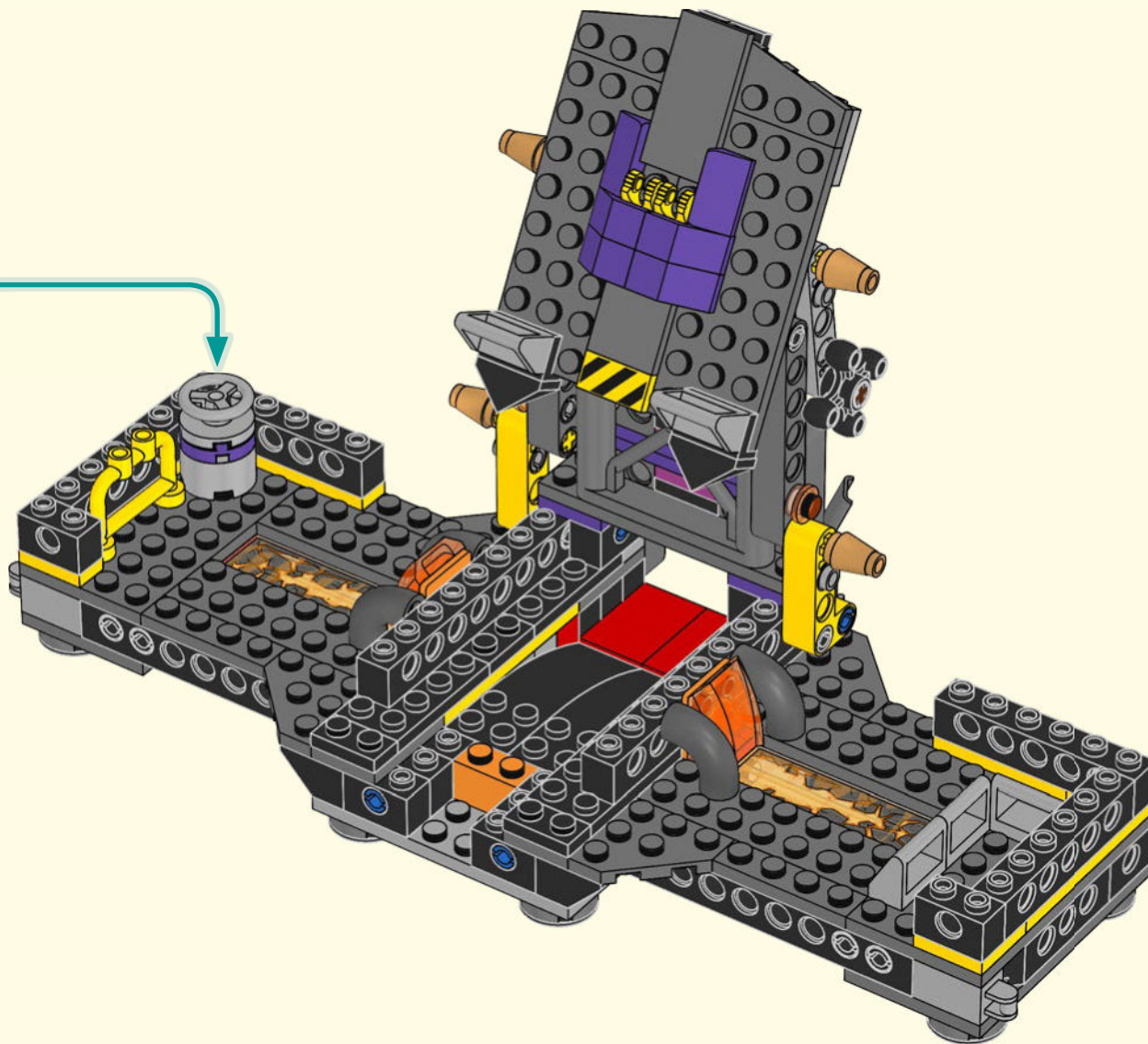
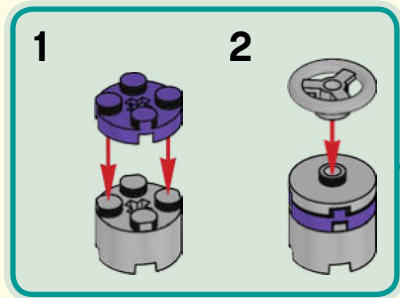

1x



1x



76

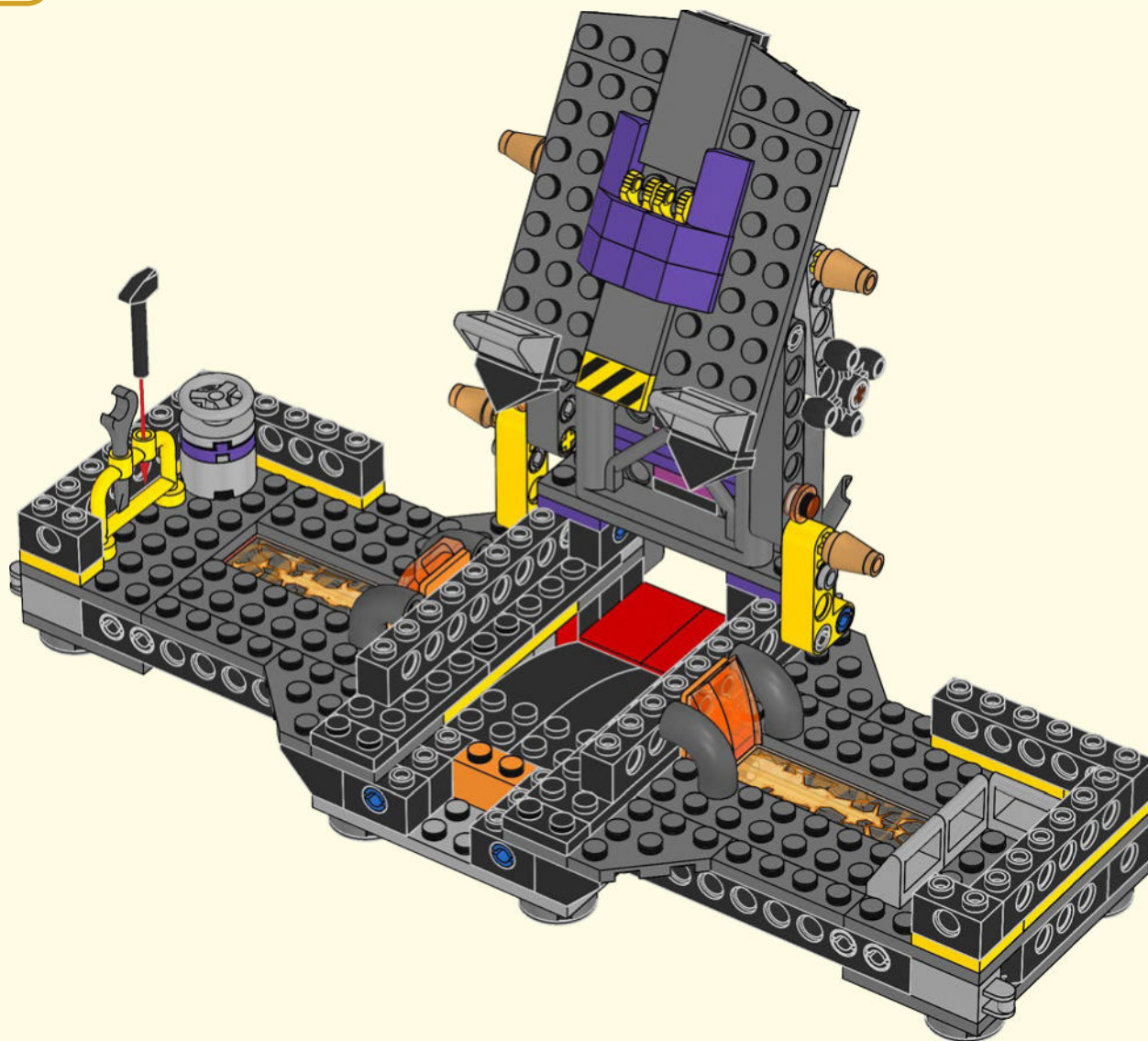

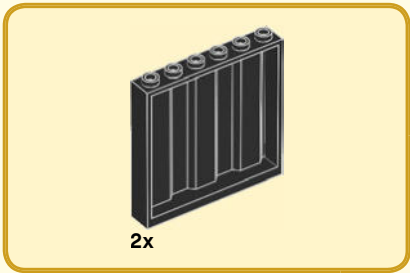

77

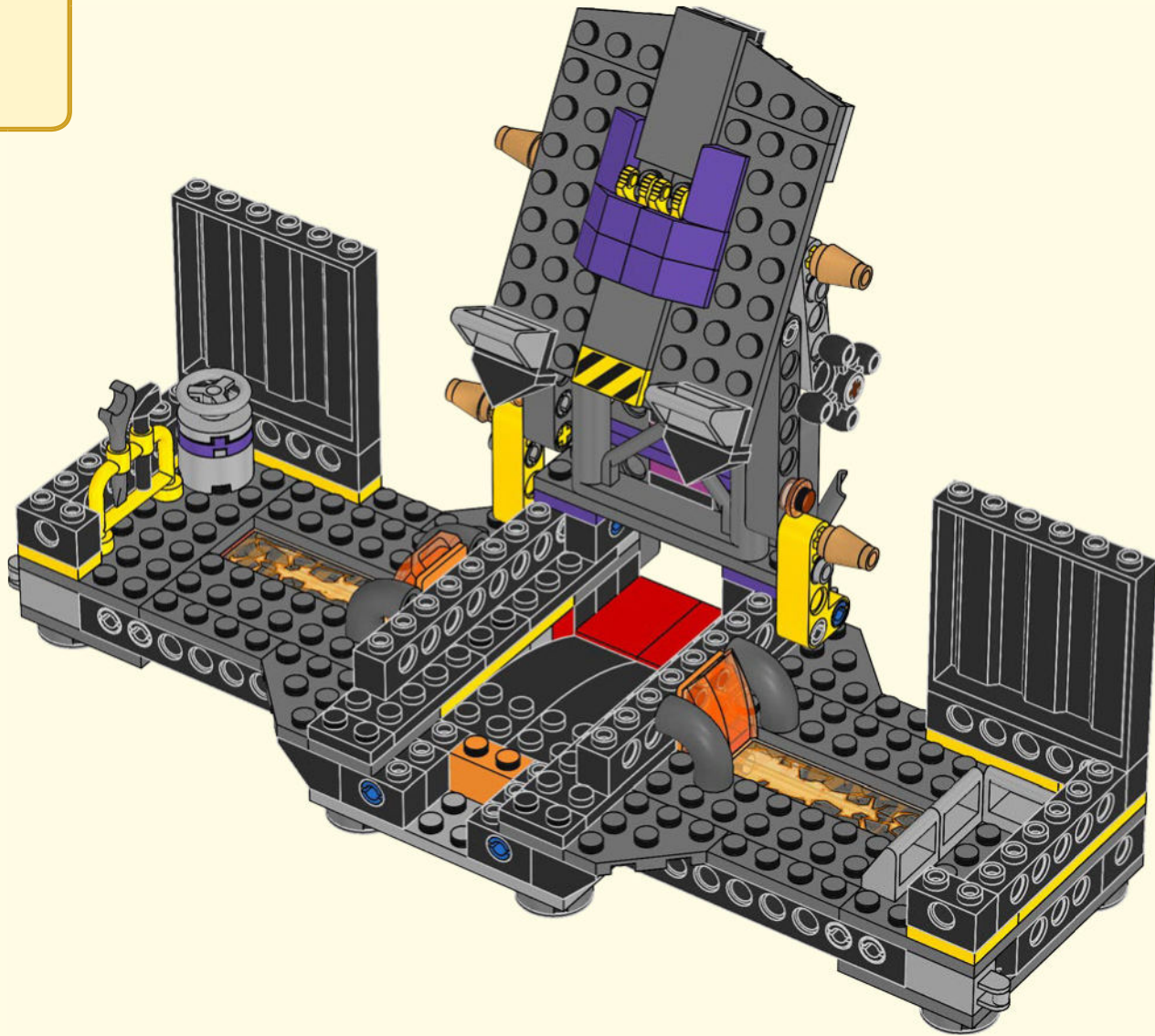

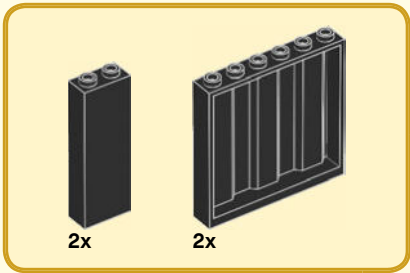

78

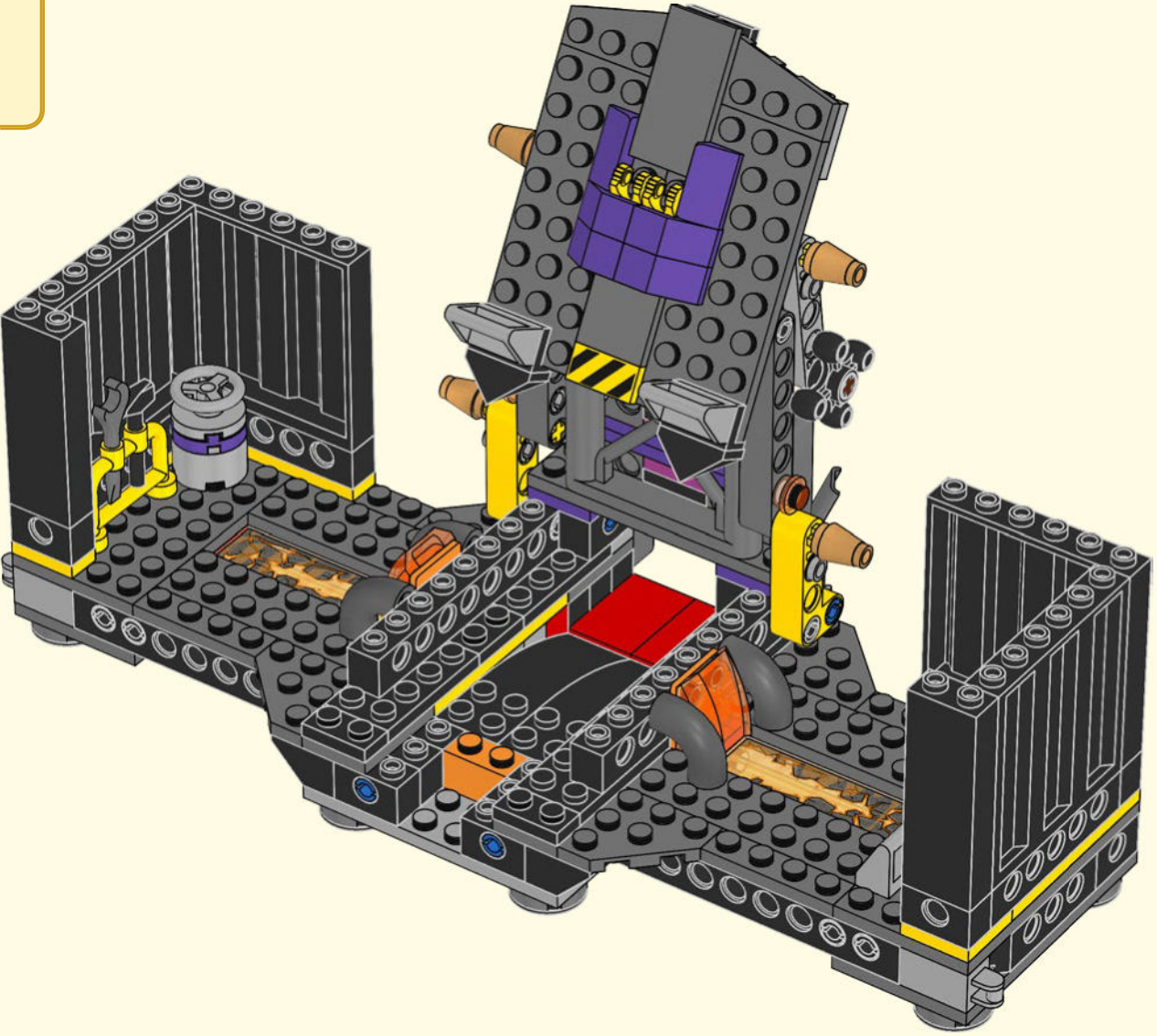



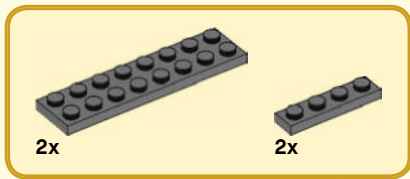

79

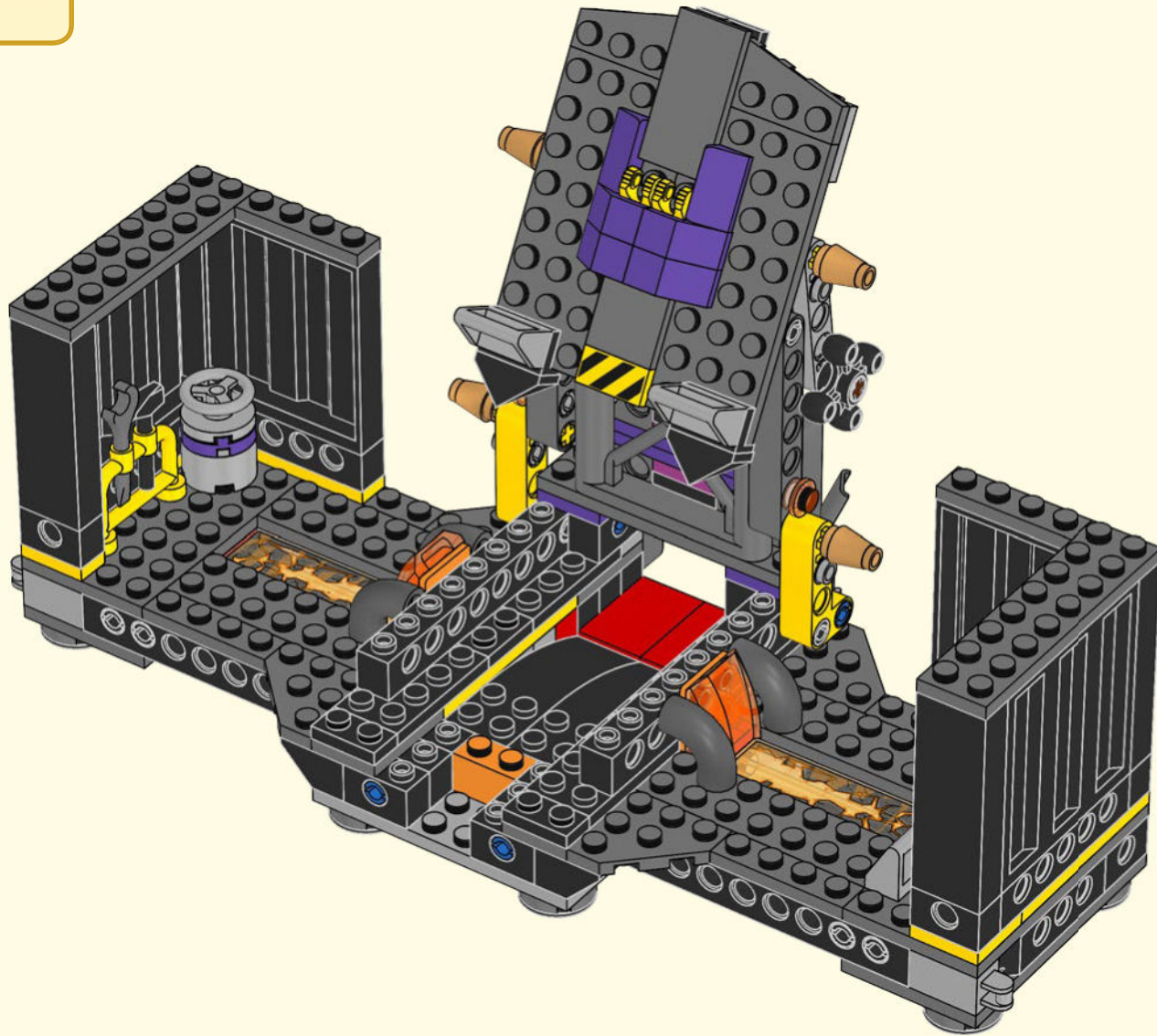

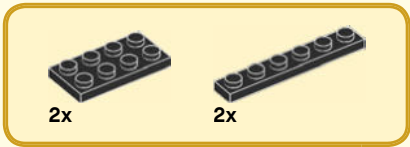

80

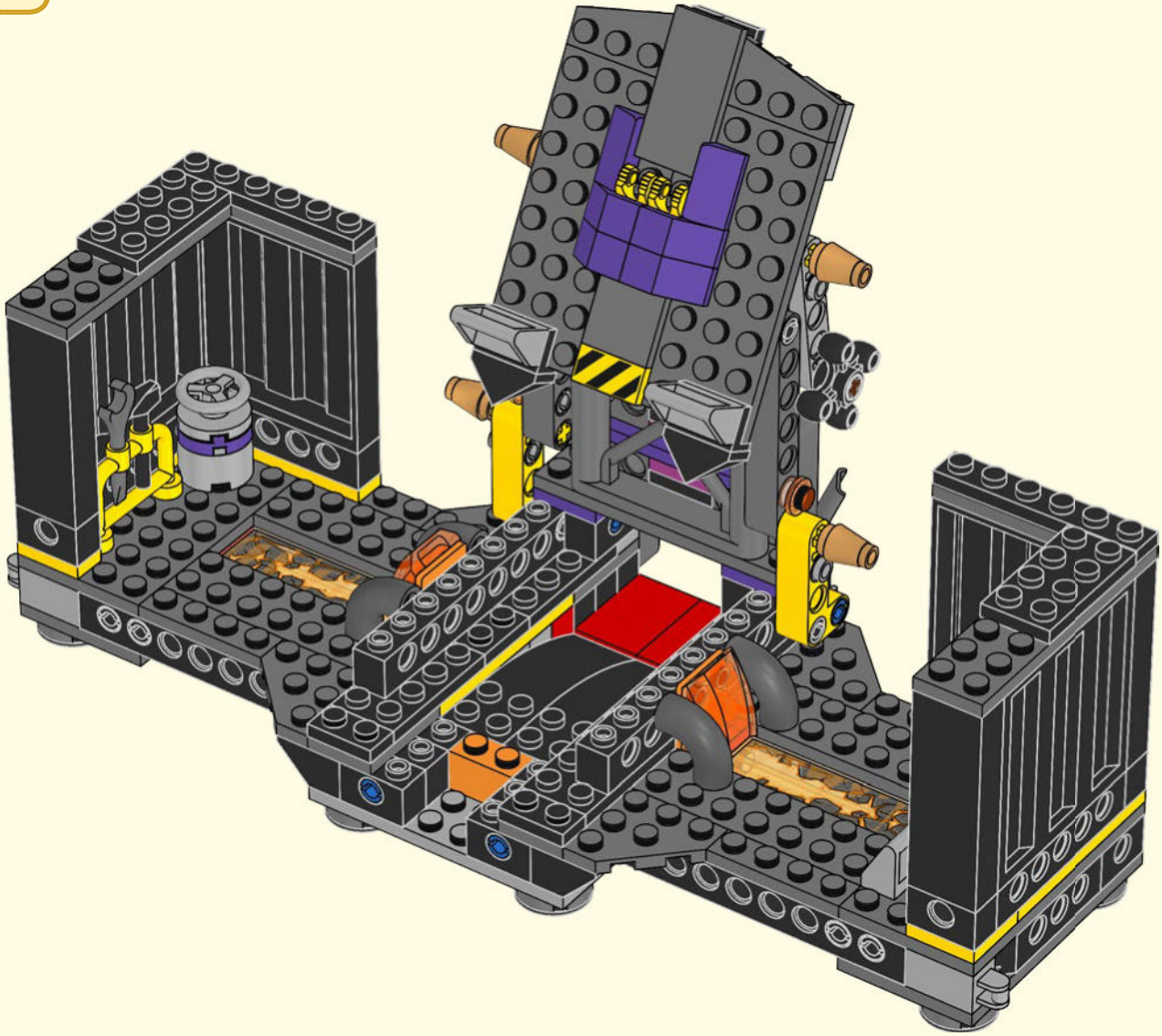

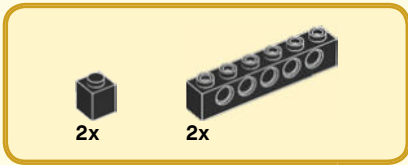

81

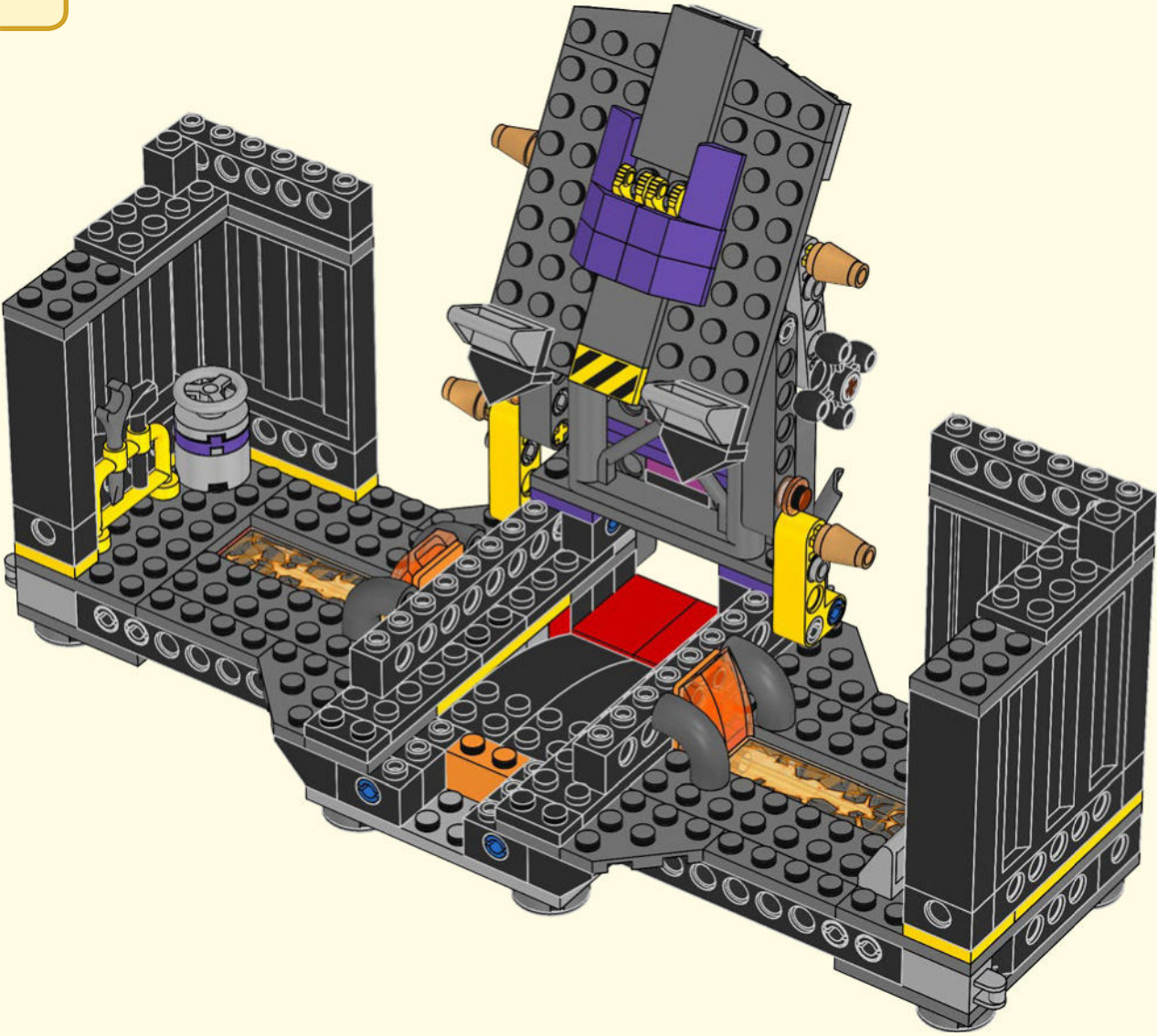

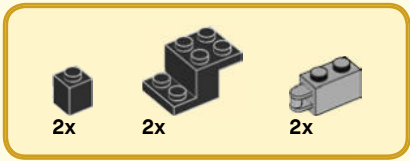

# 82

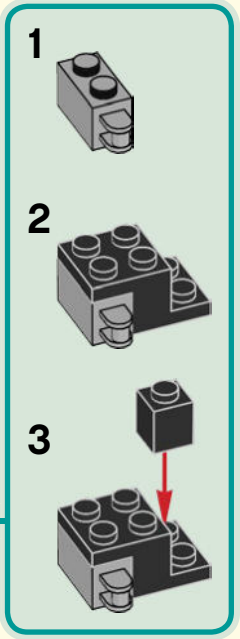
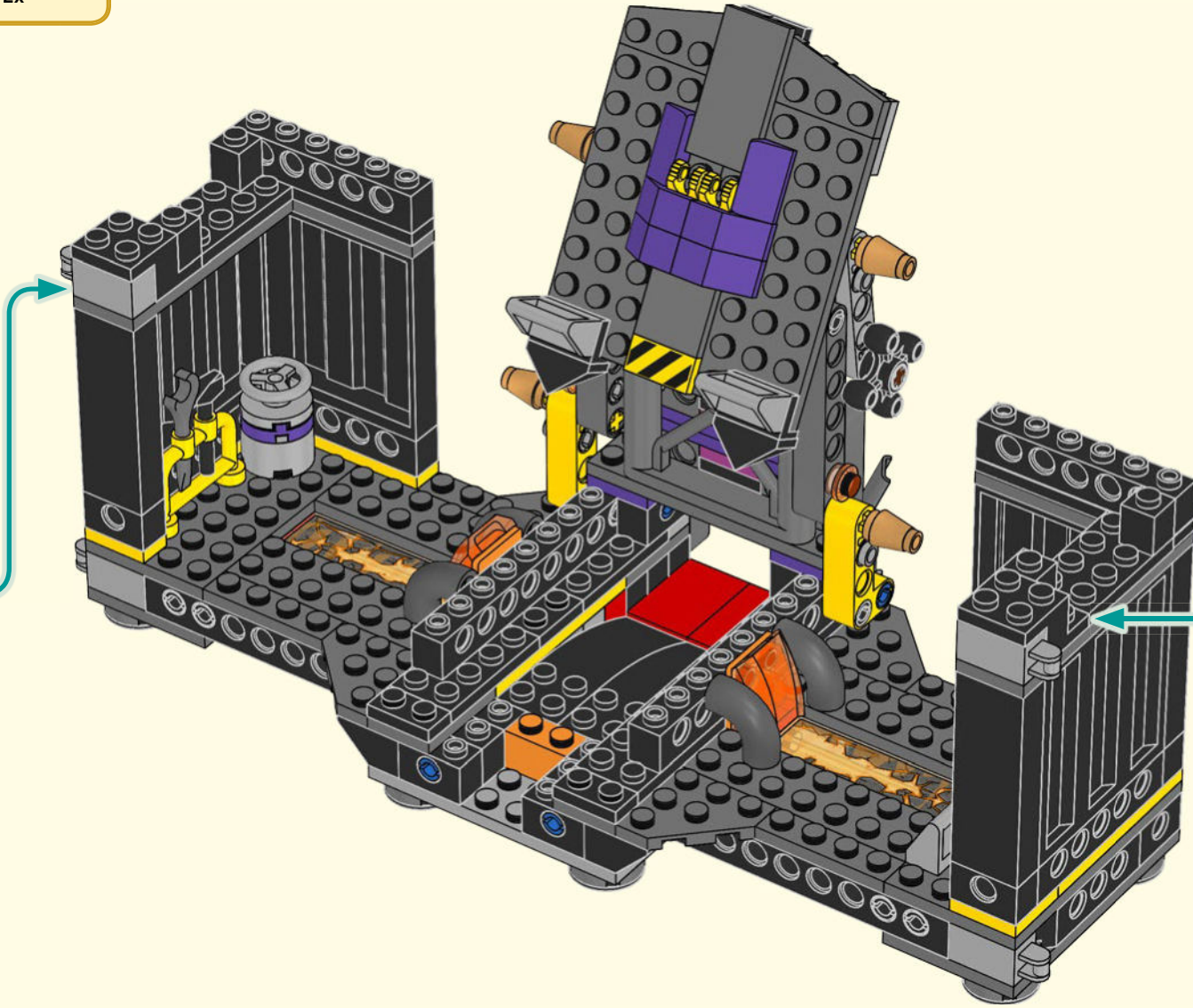
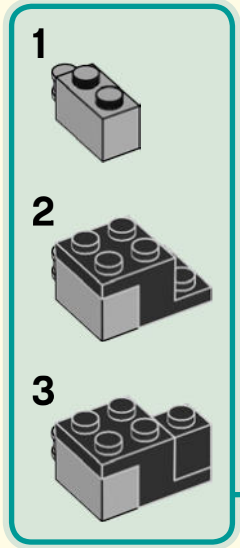

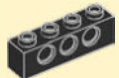

2x

83

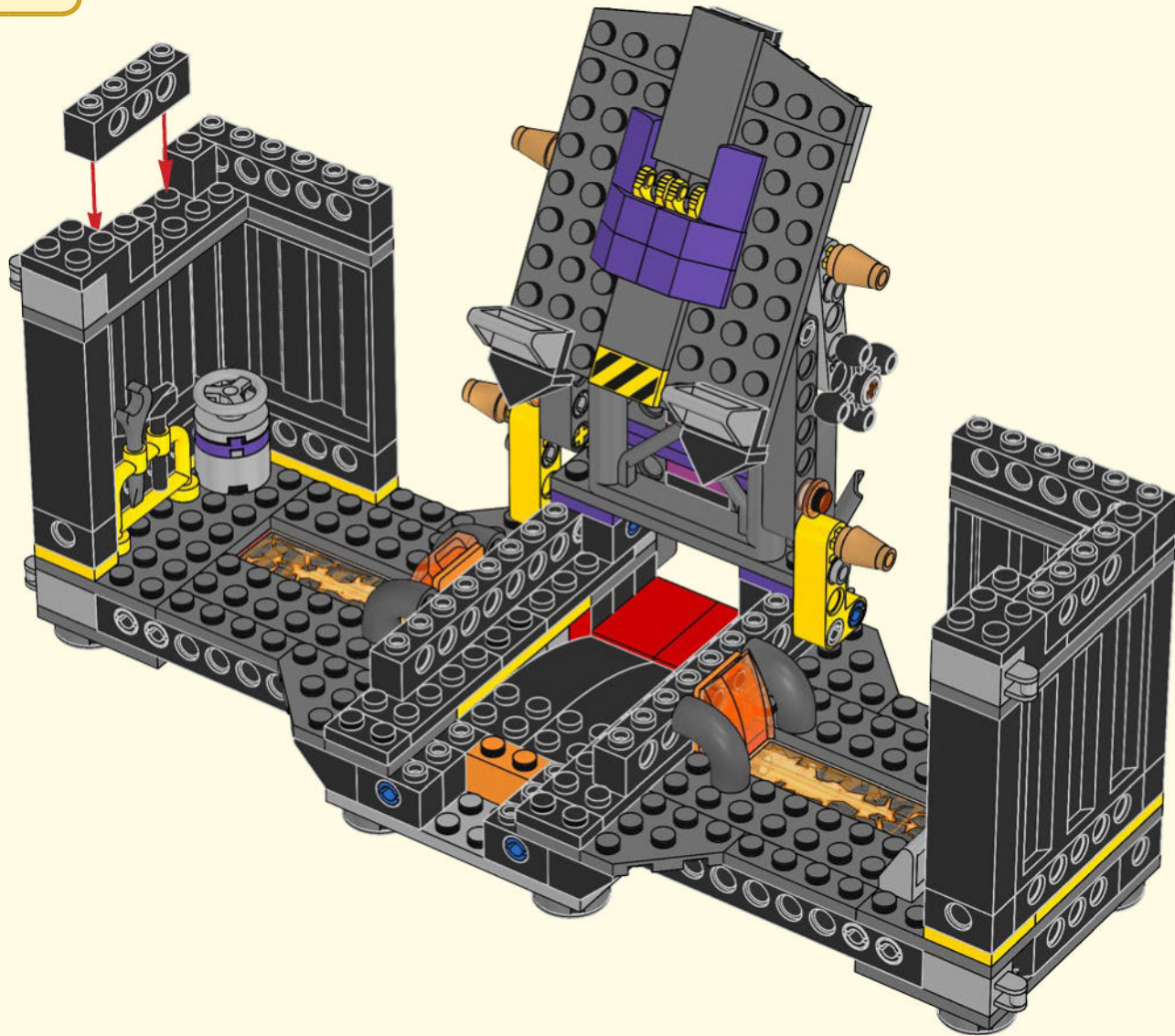

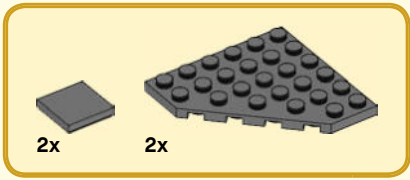

84

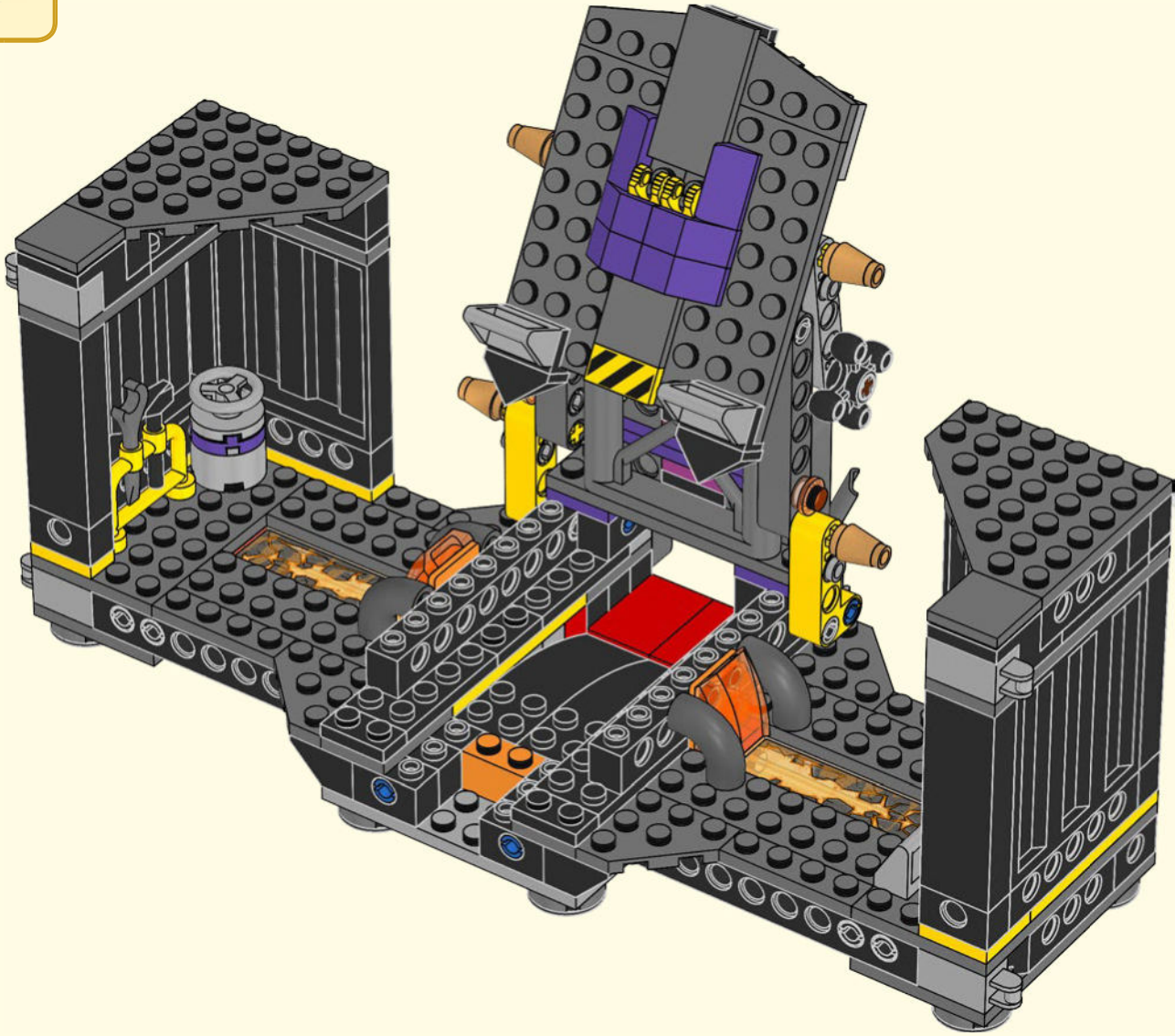

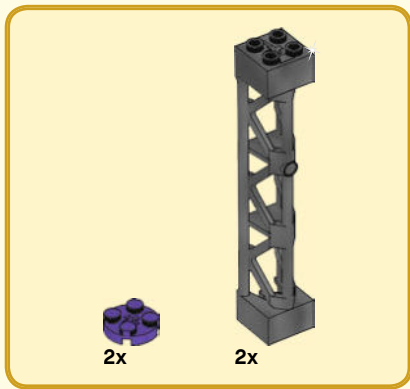

85

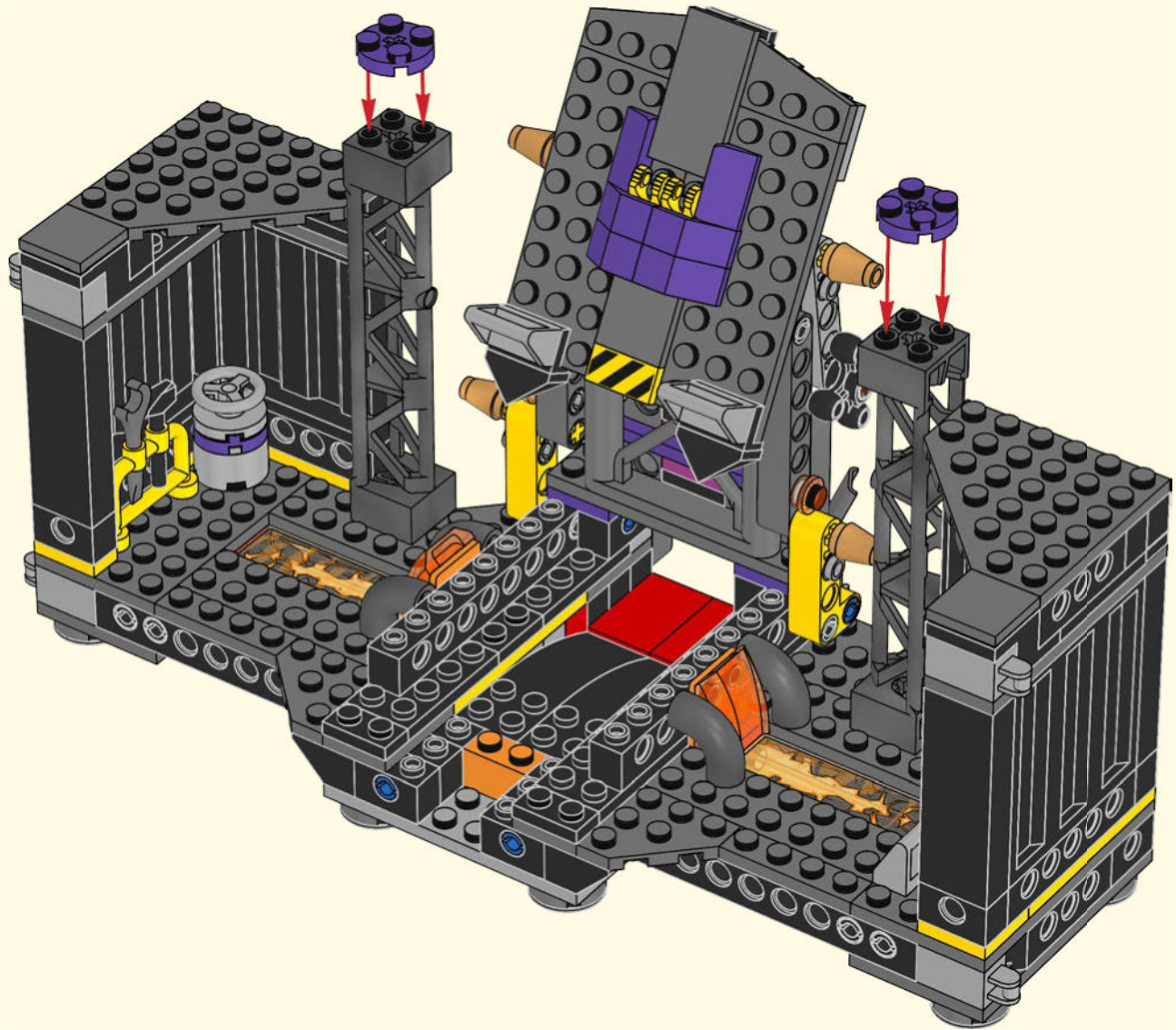

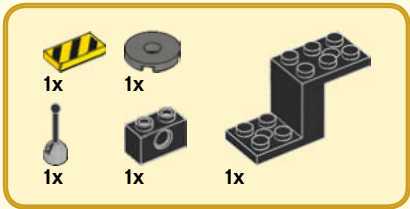

86

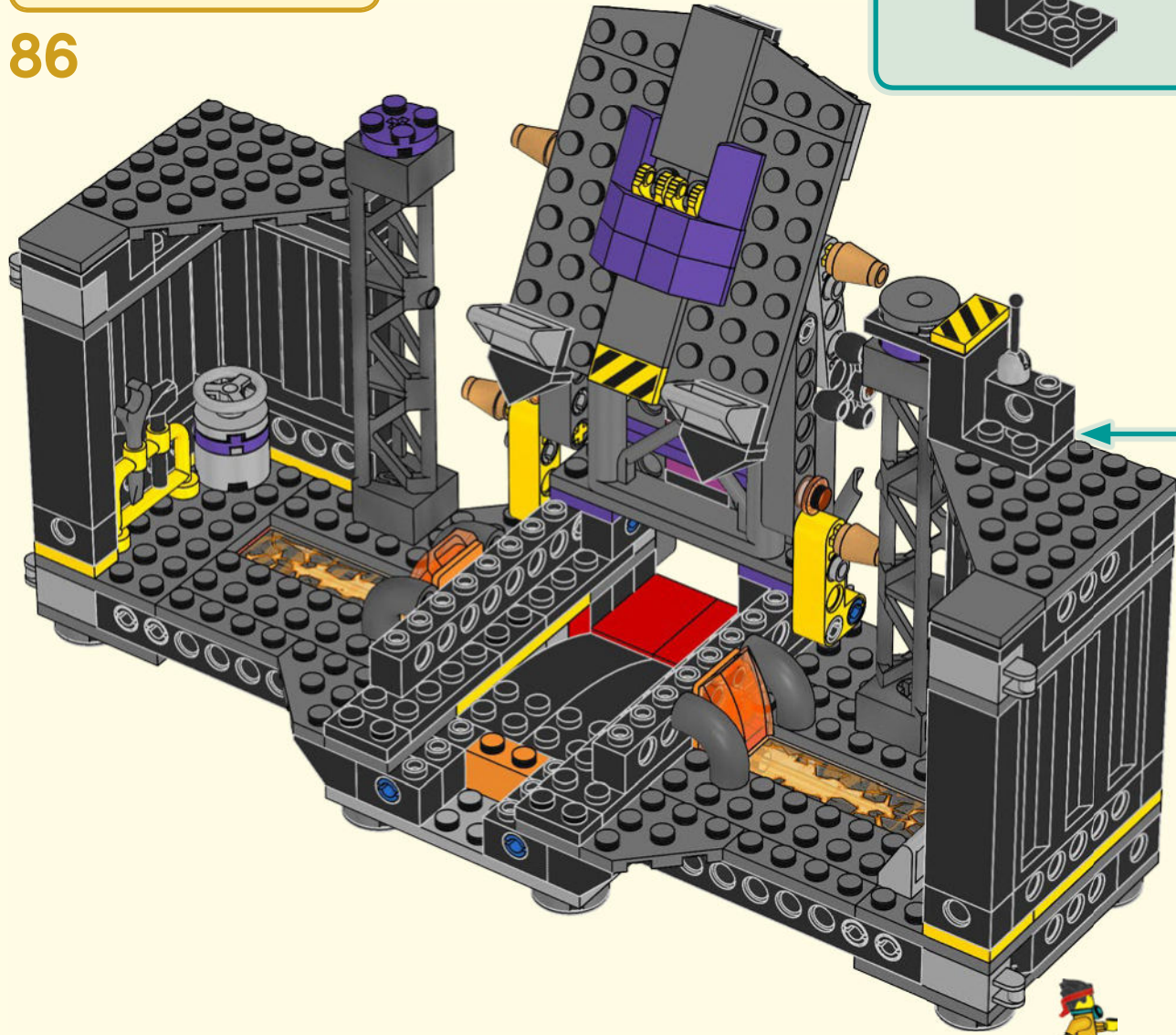
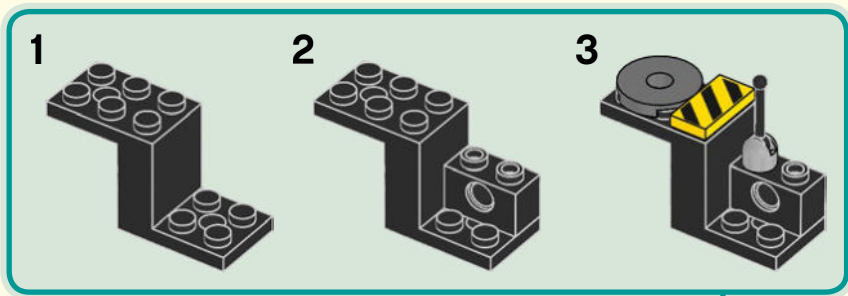



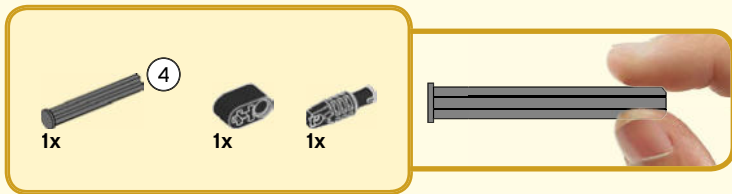

87

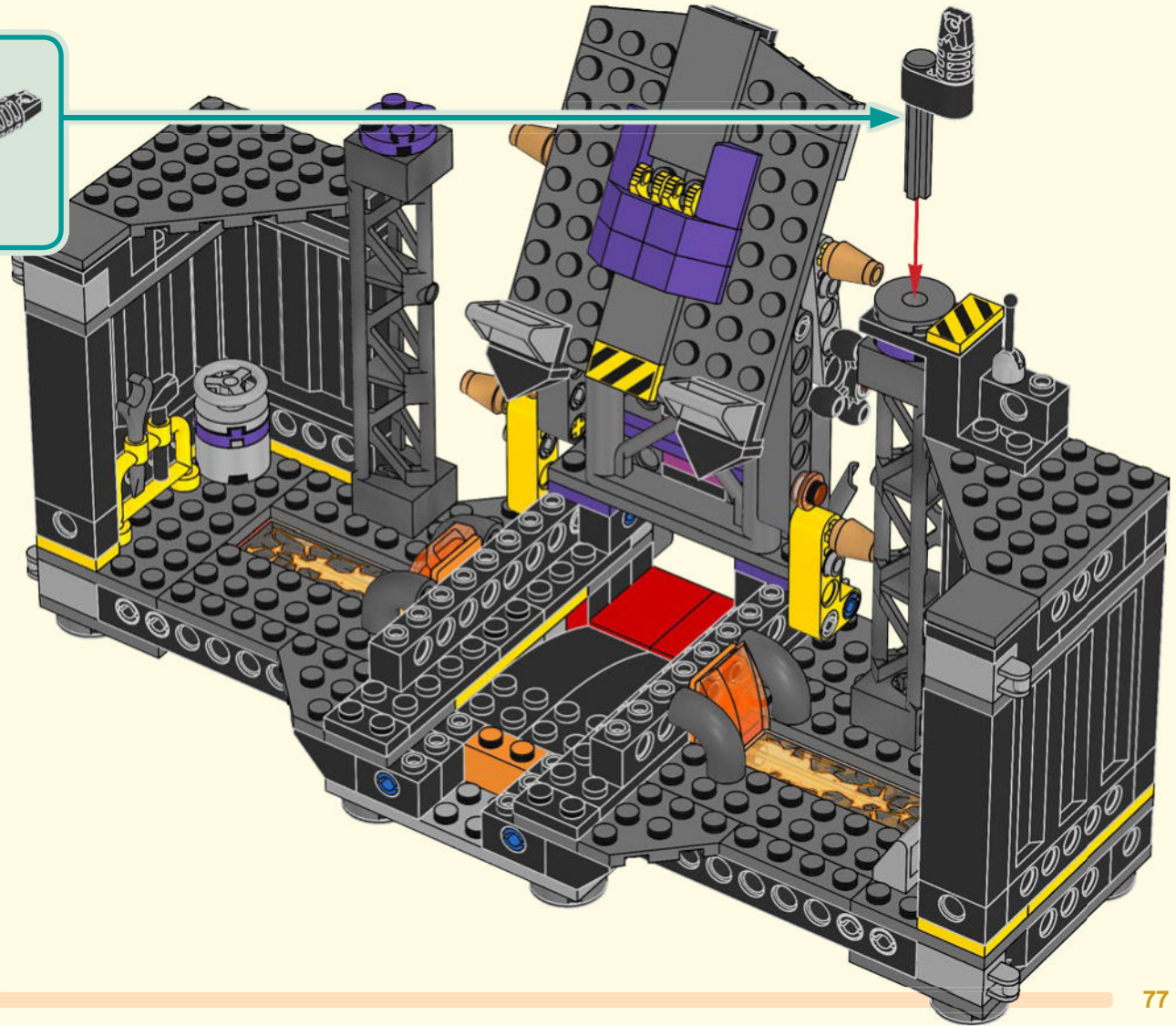
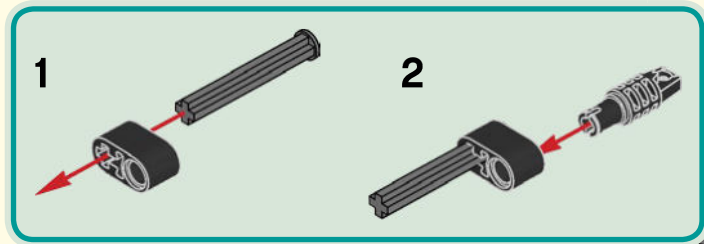

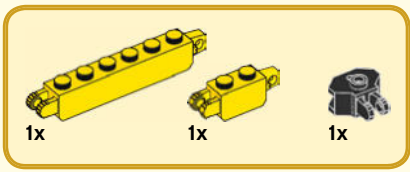

88

1

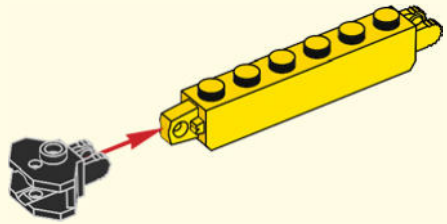

2

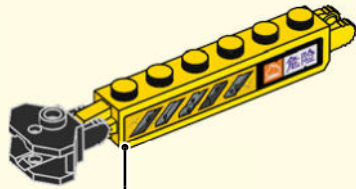

3

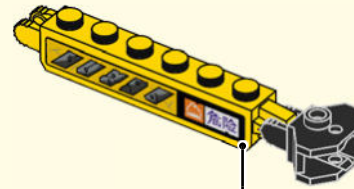
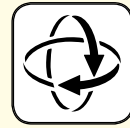

4

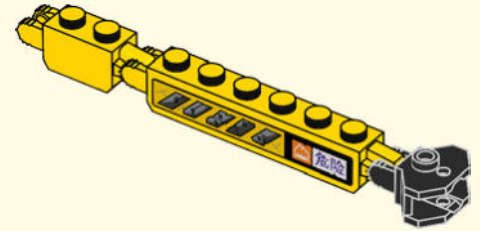

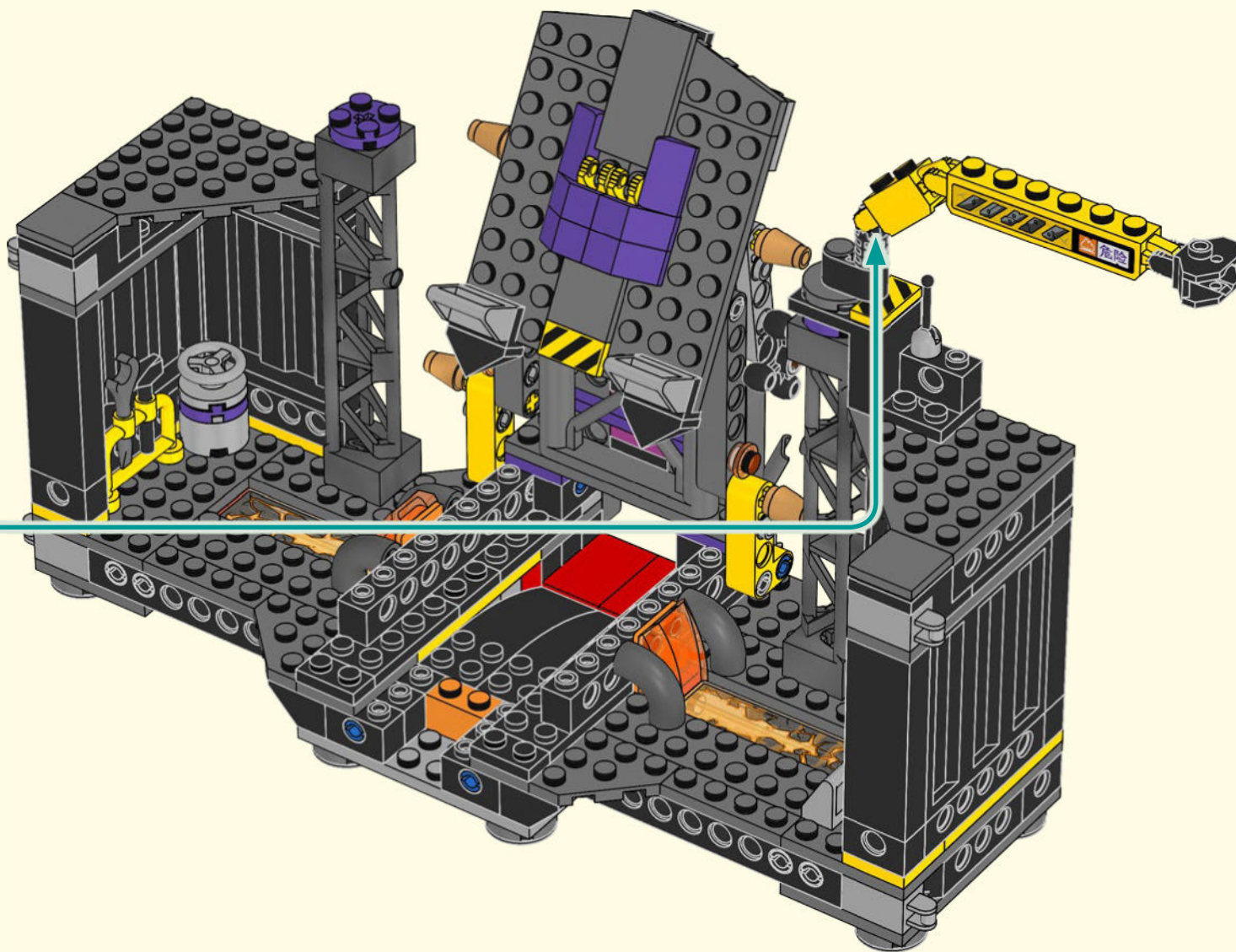



89

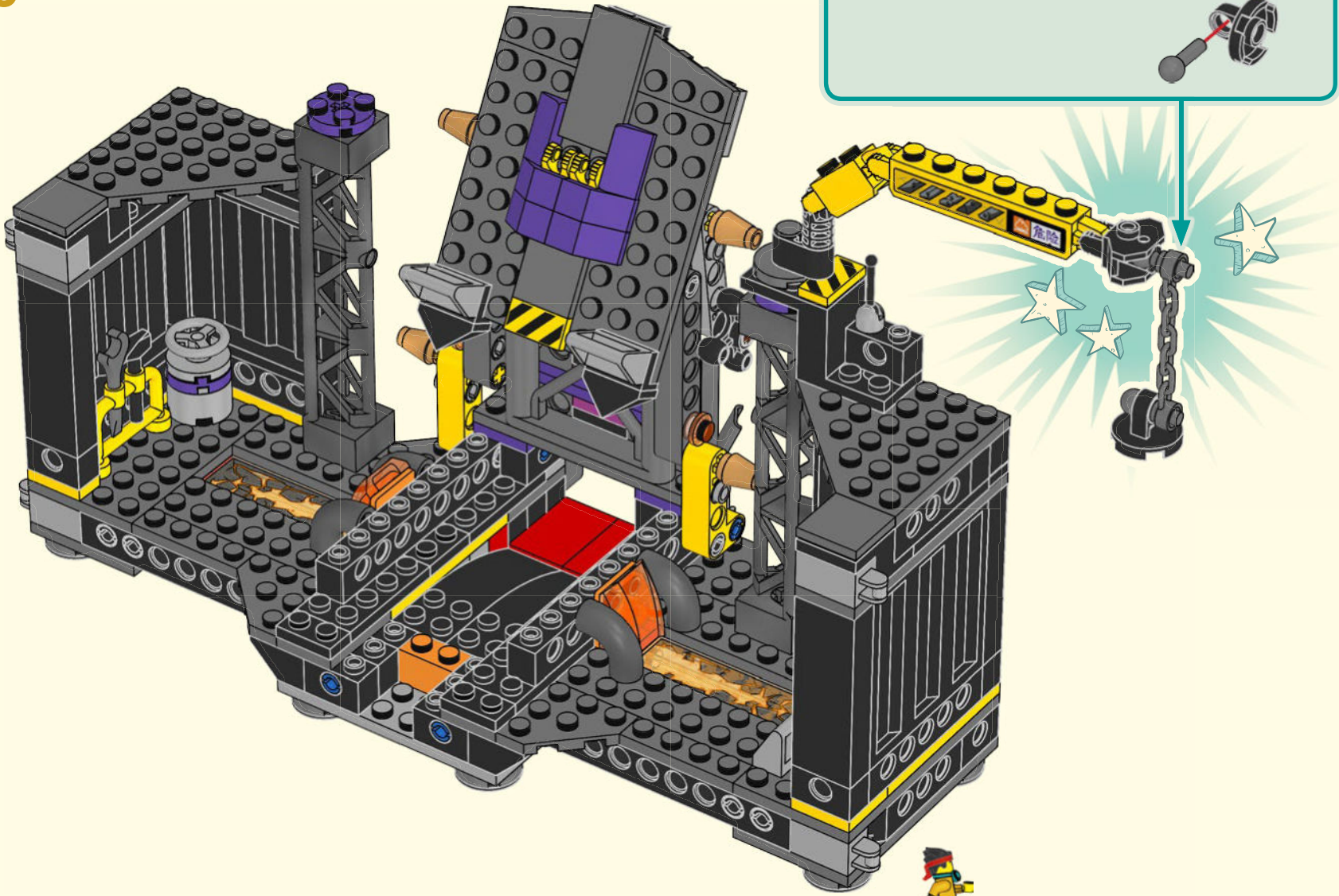
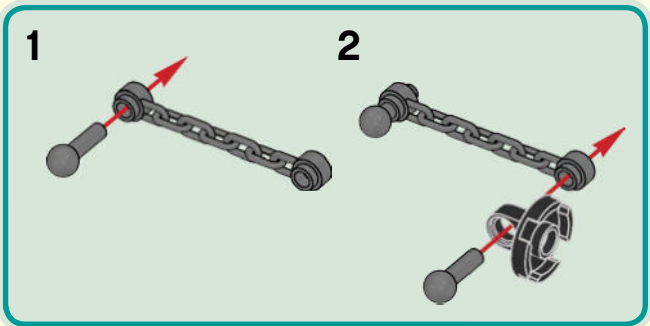



90

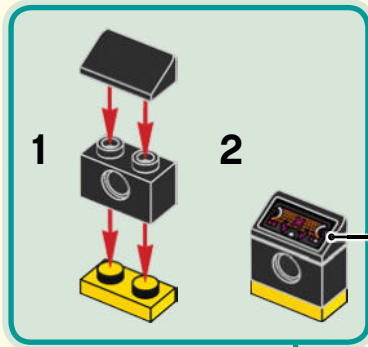
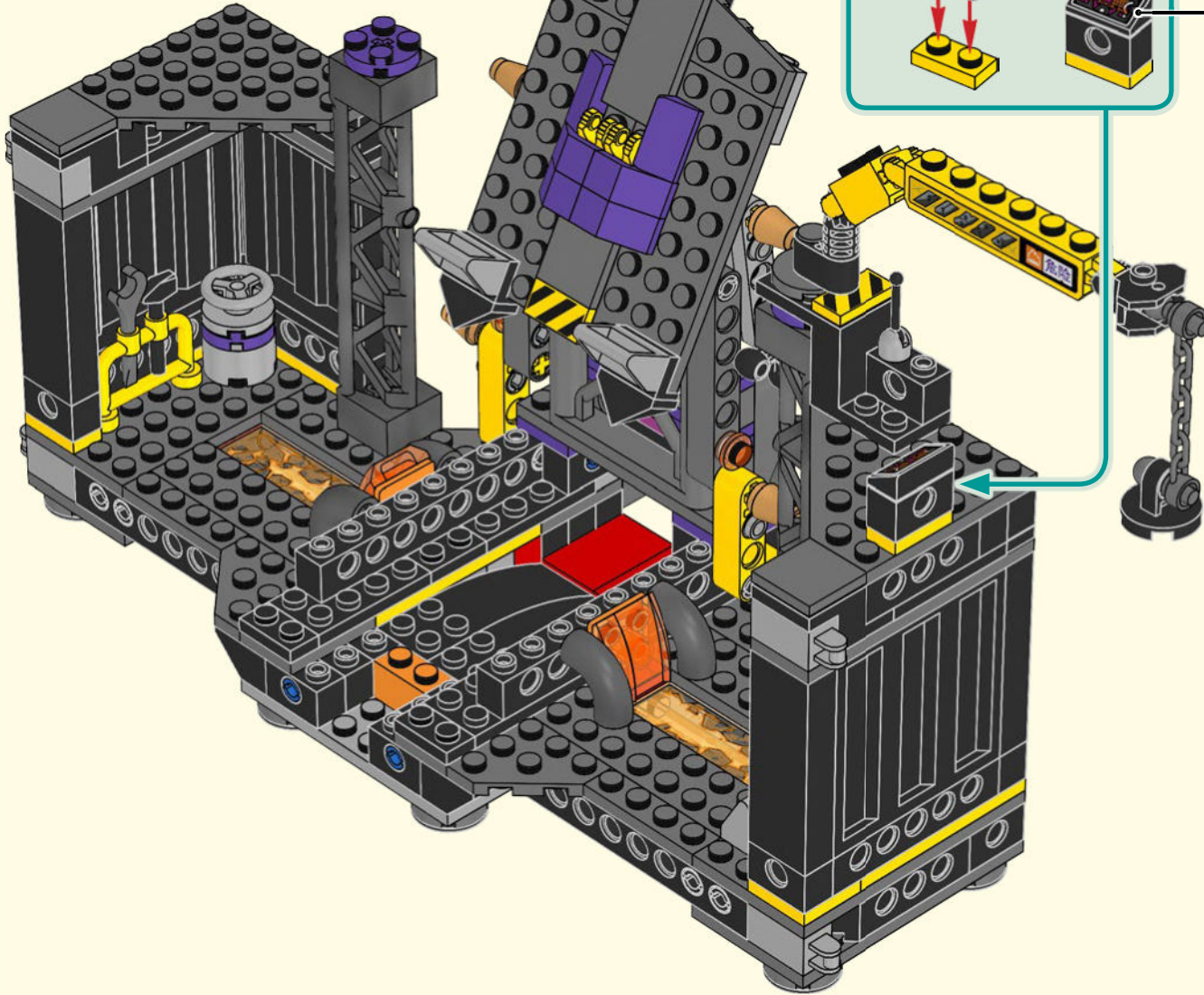

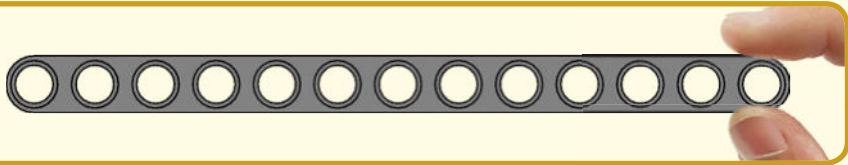
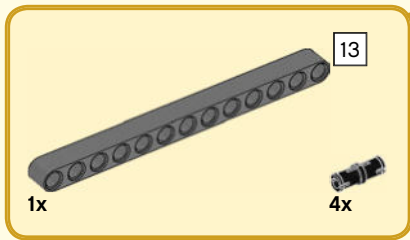

91

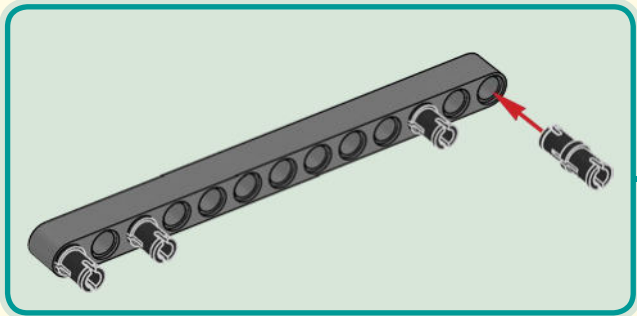
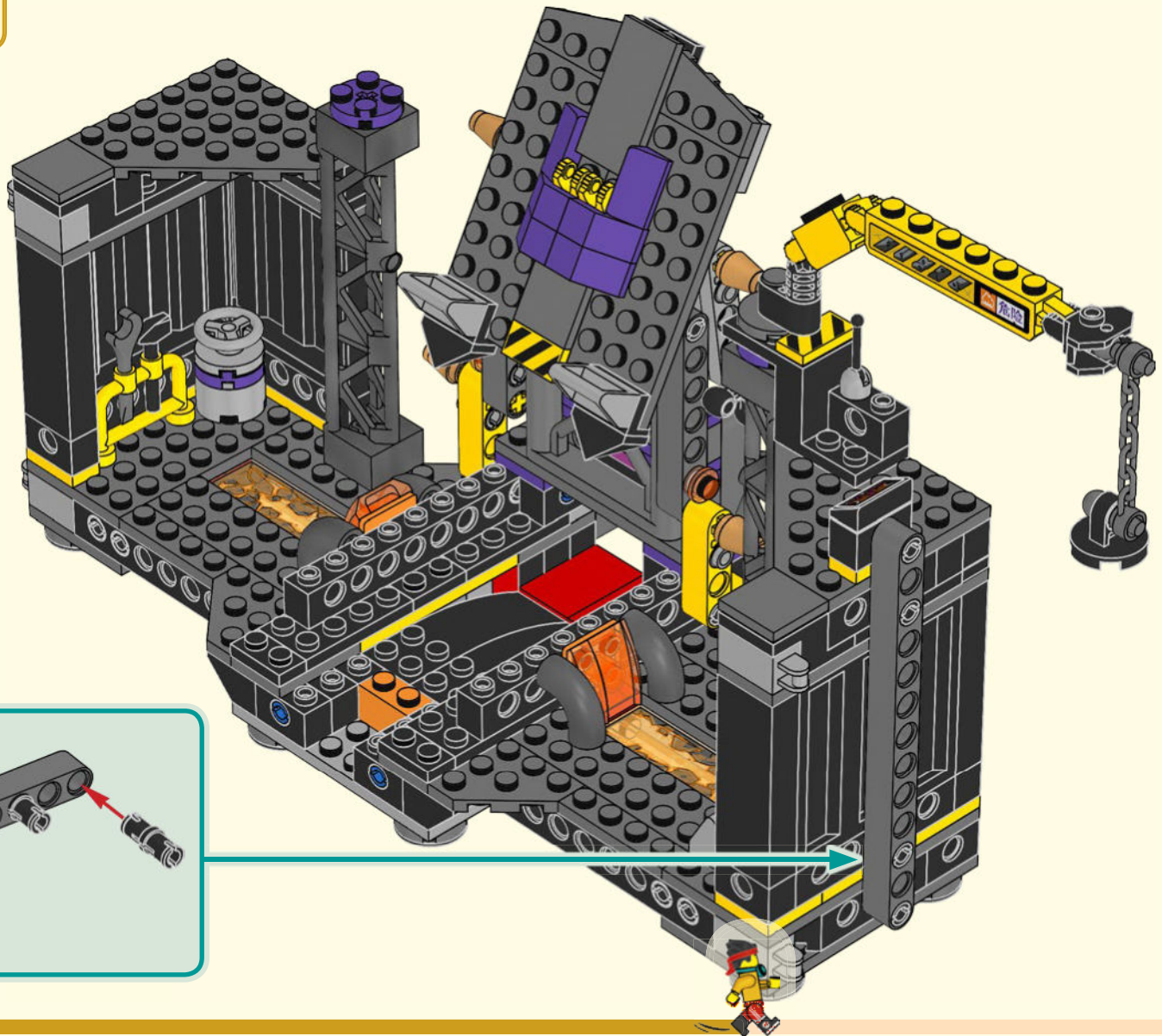

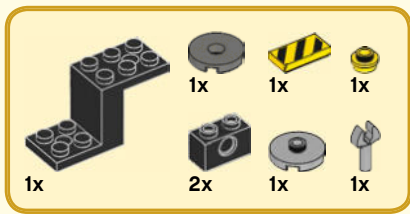

92

1

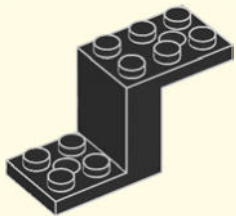

2

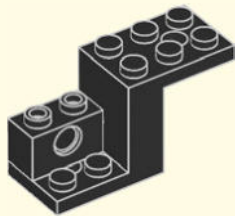

3

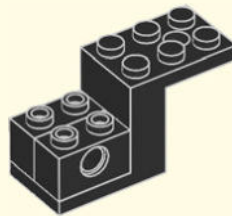

4



5

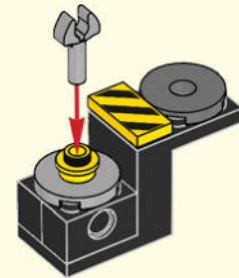

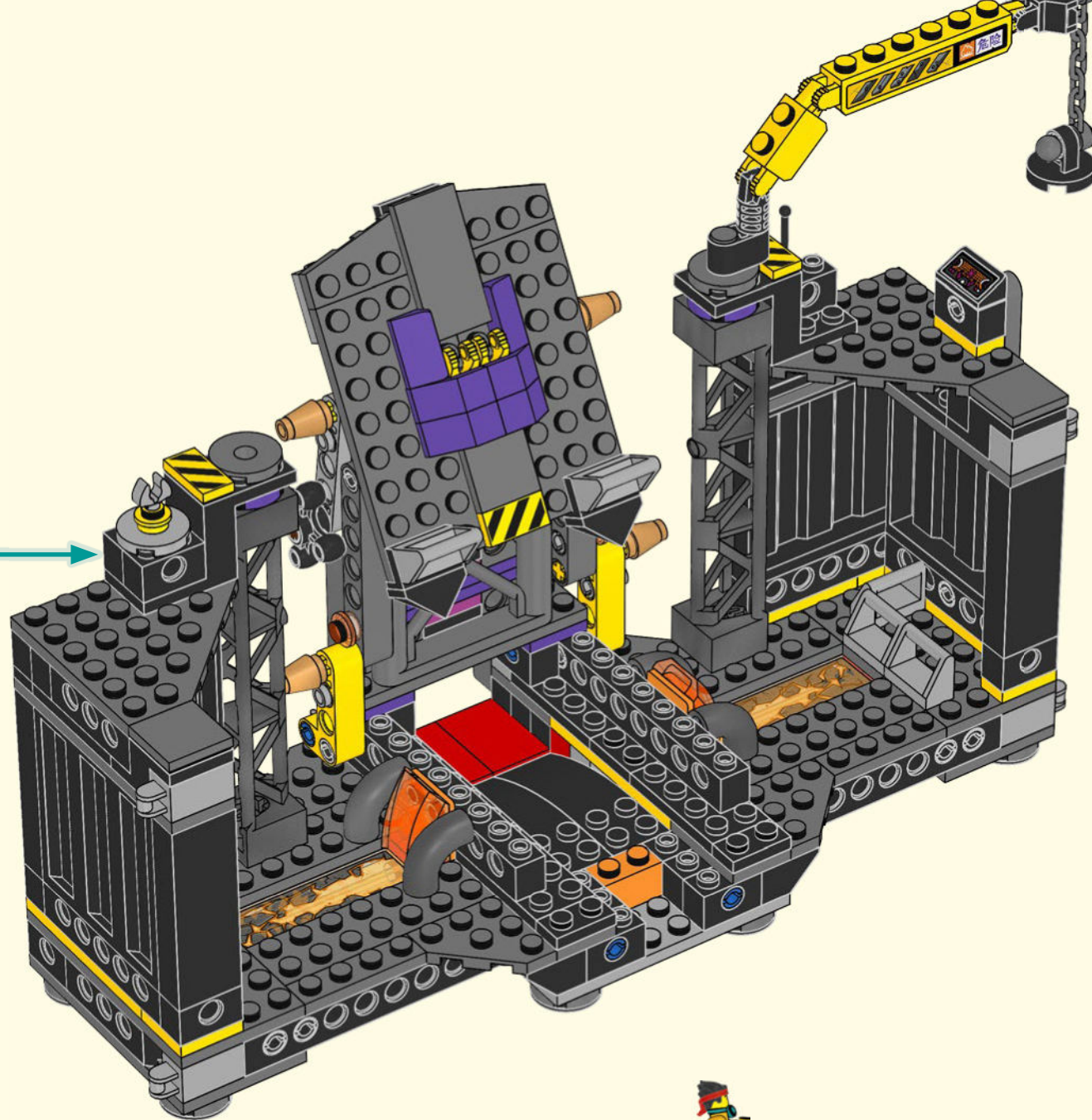





93

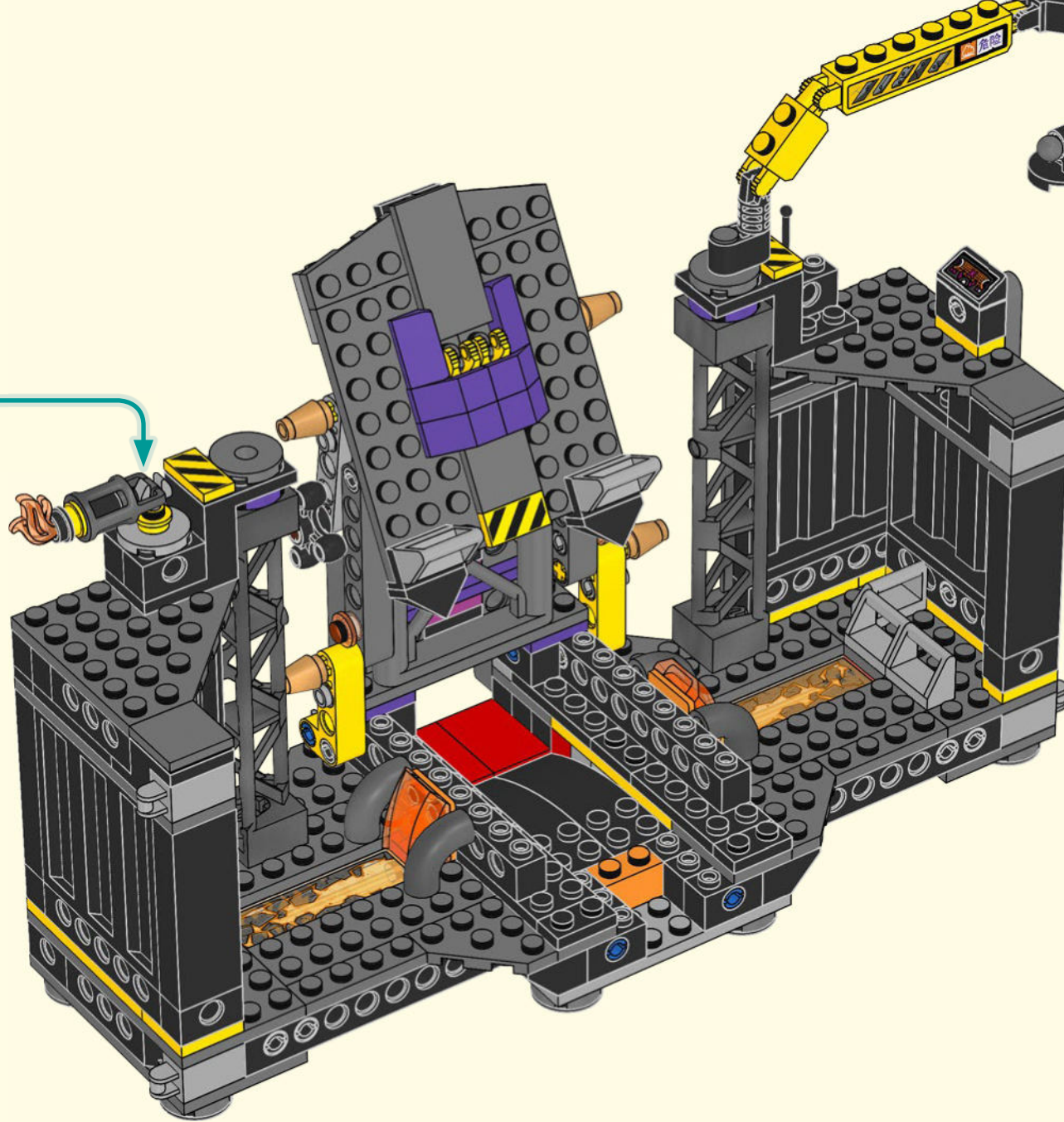
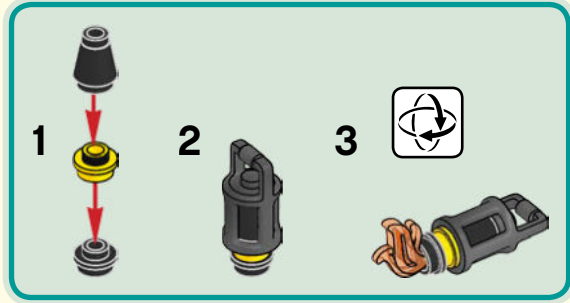

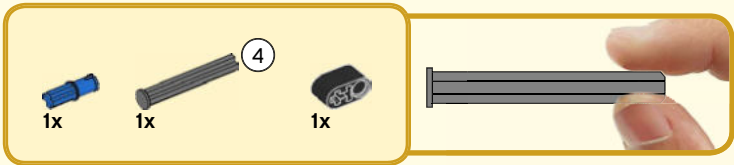

94

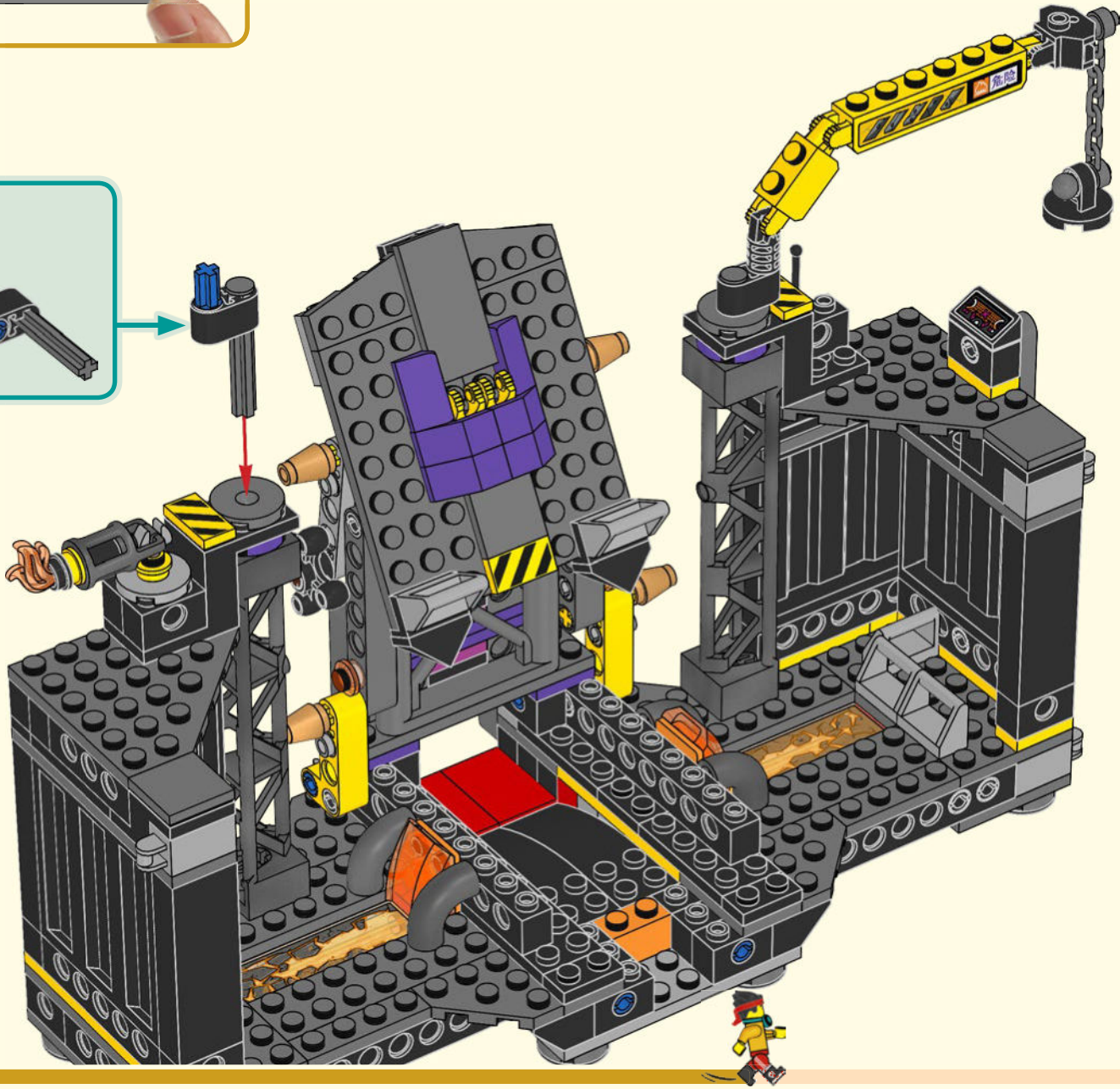
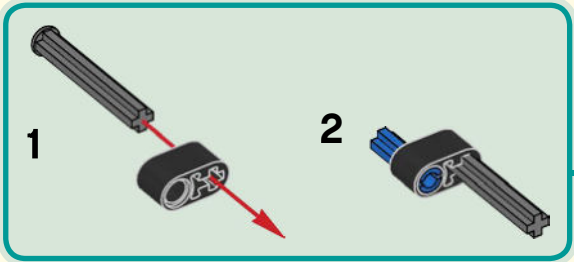



95

1

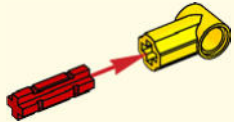

2

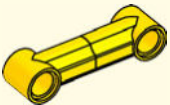

3



4



5

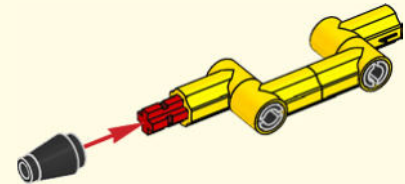

6

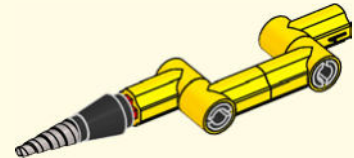

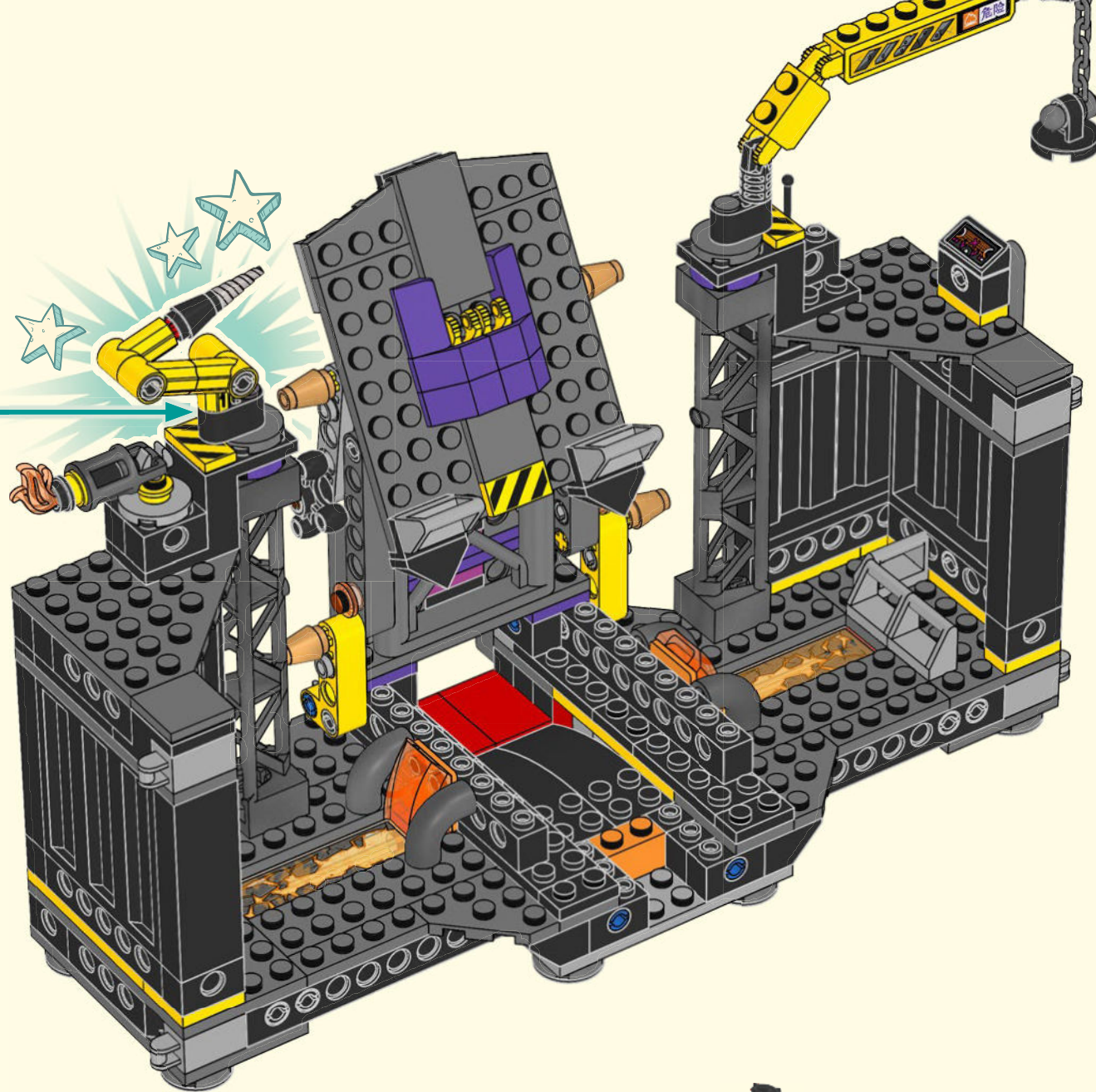



96

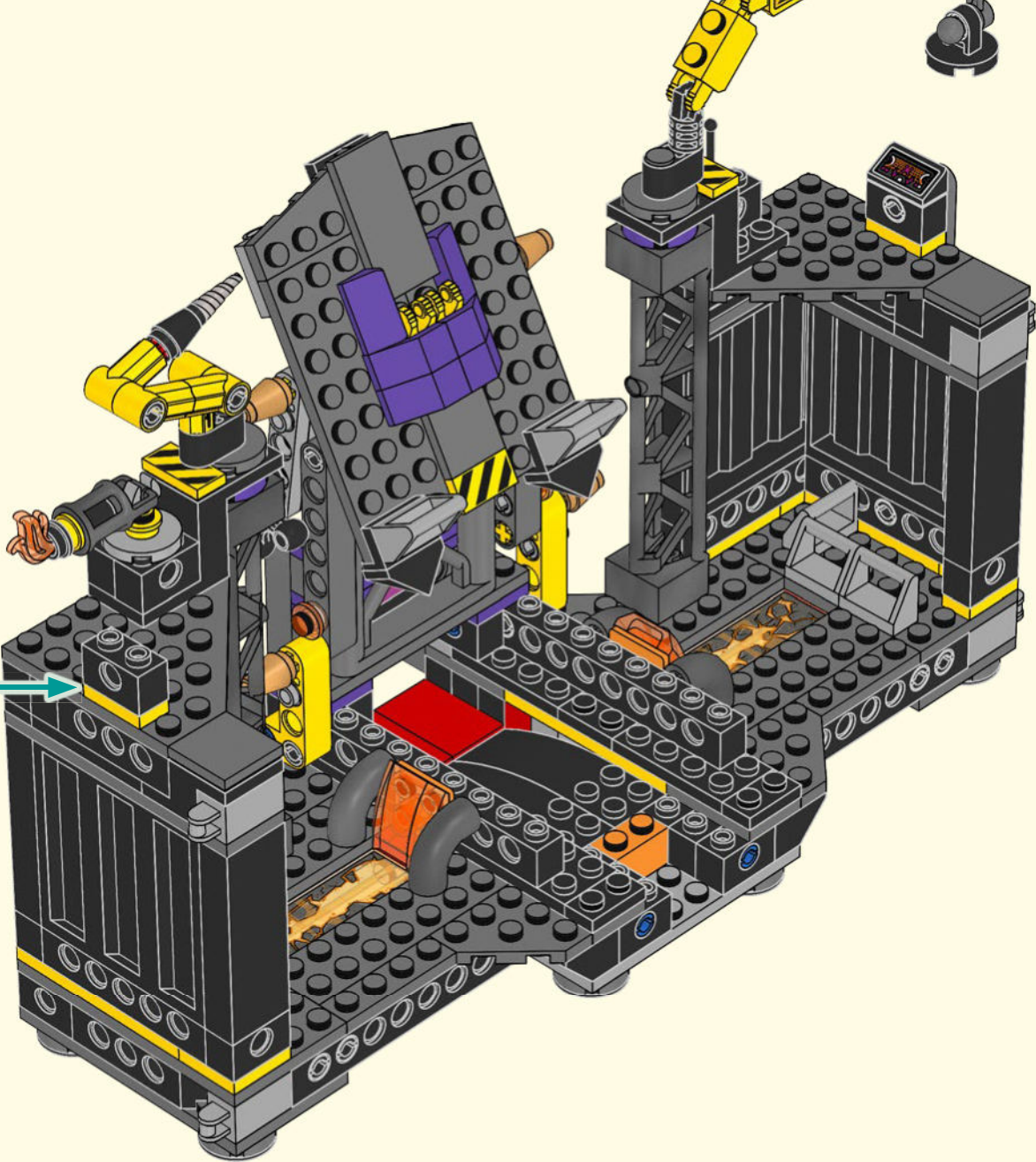
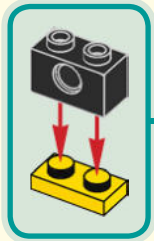

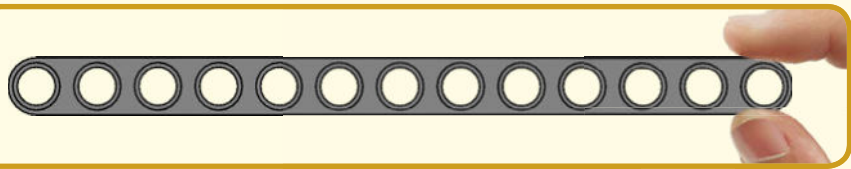
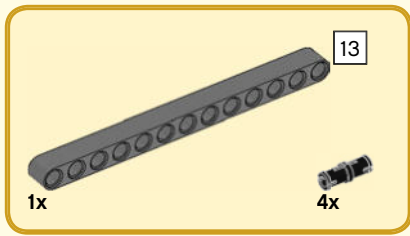

97

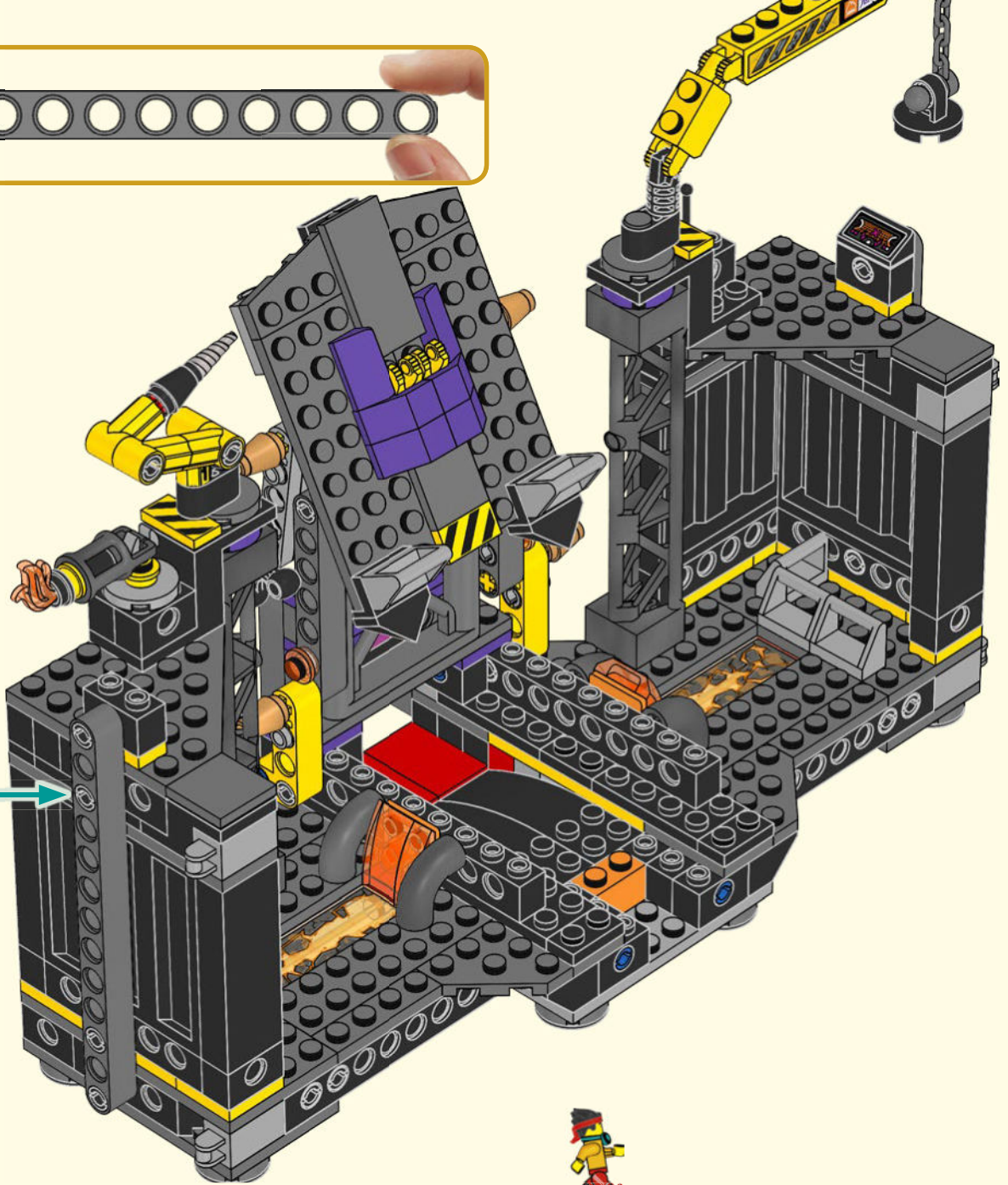
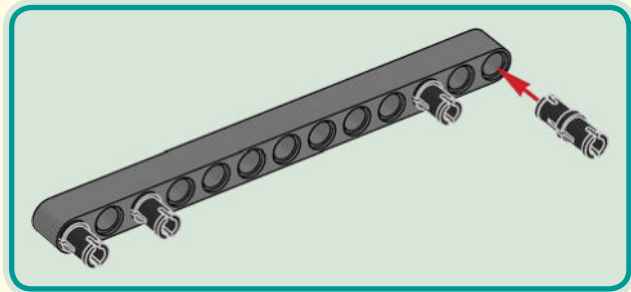

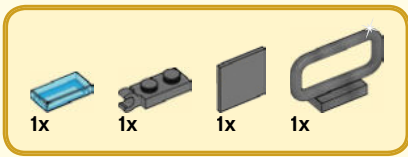

98

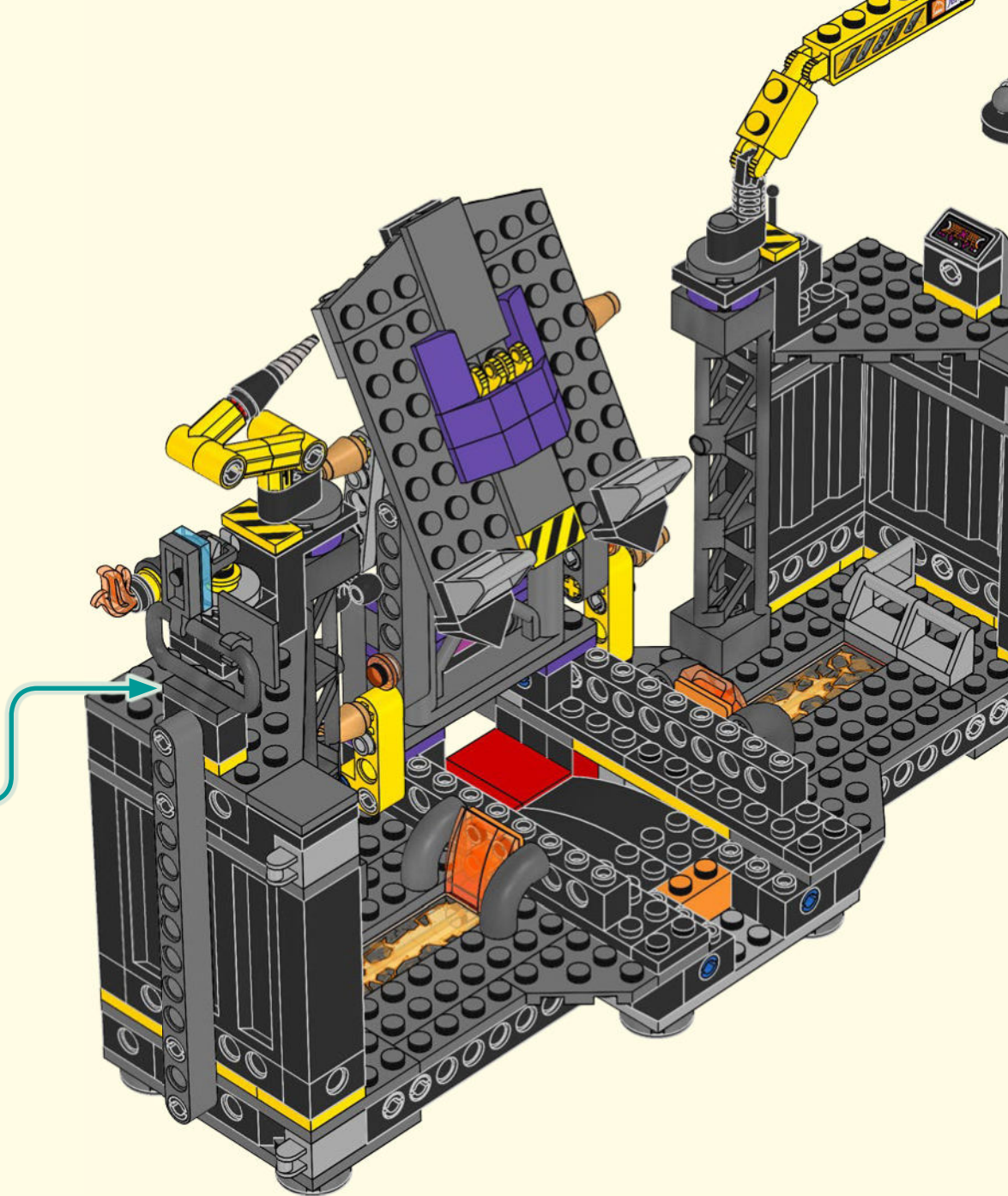
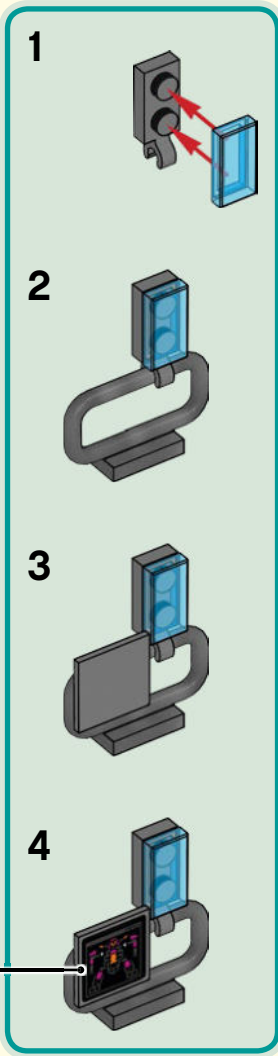

1x

99

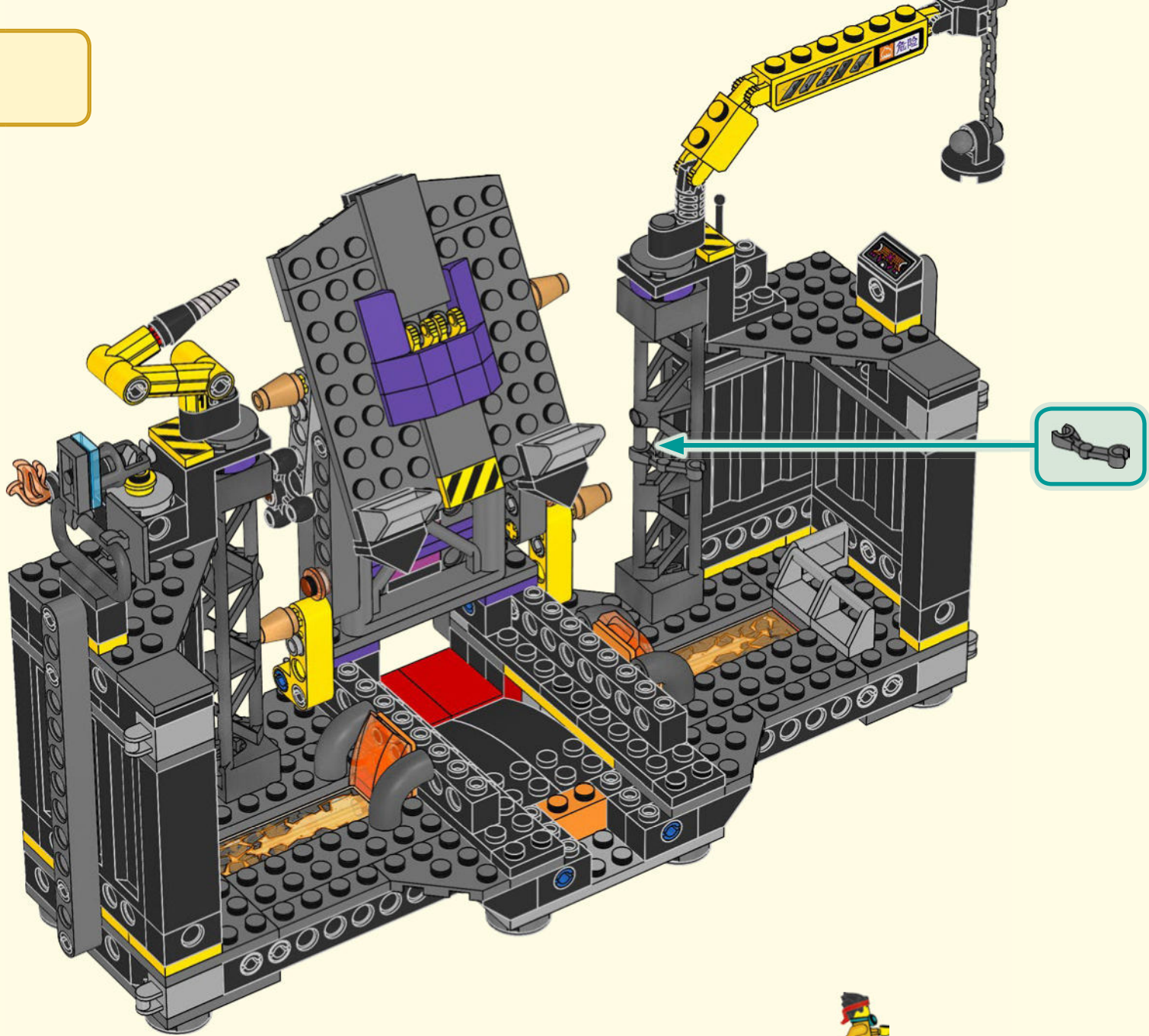





100

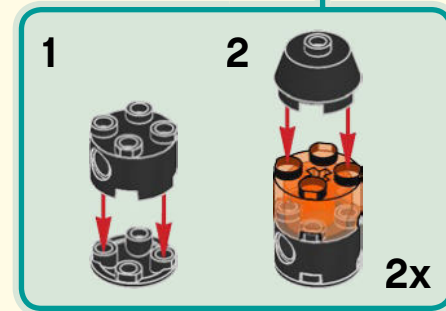
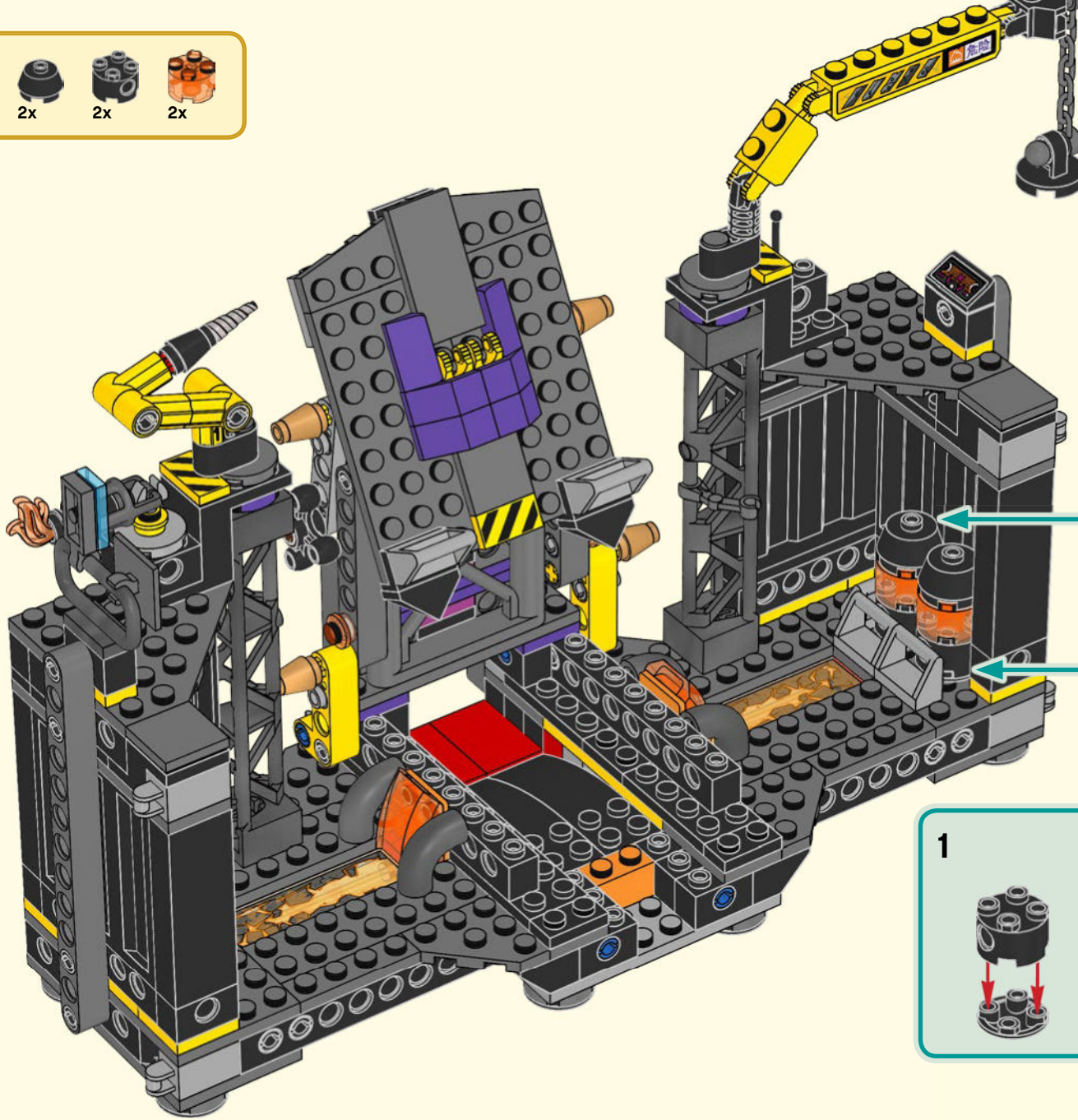



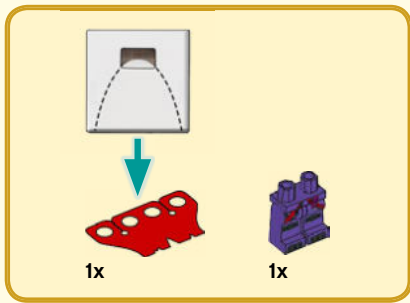

1

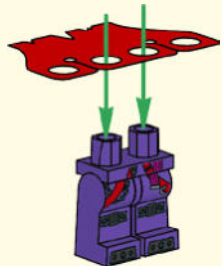

2

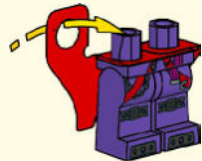

3

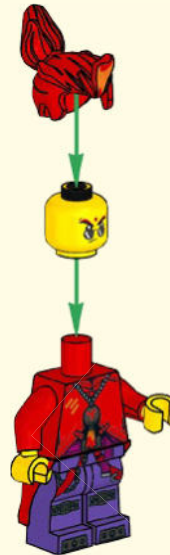

4

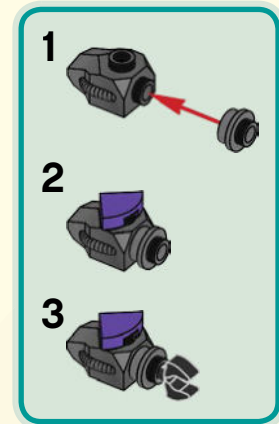

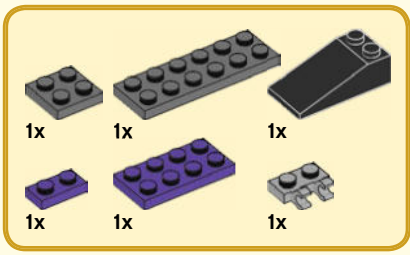

101

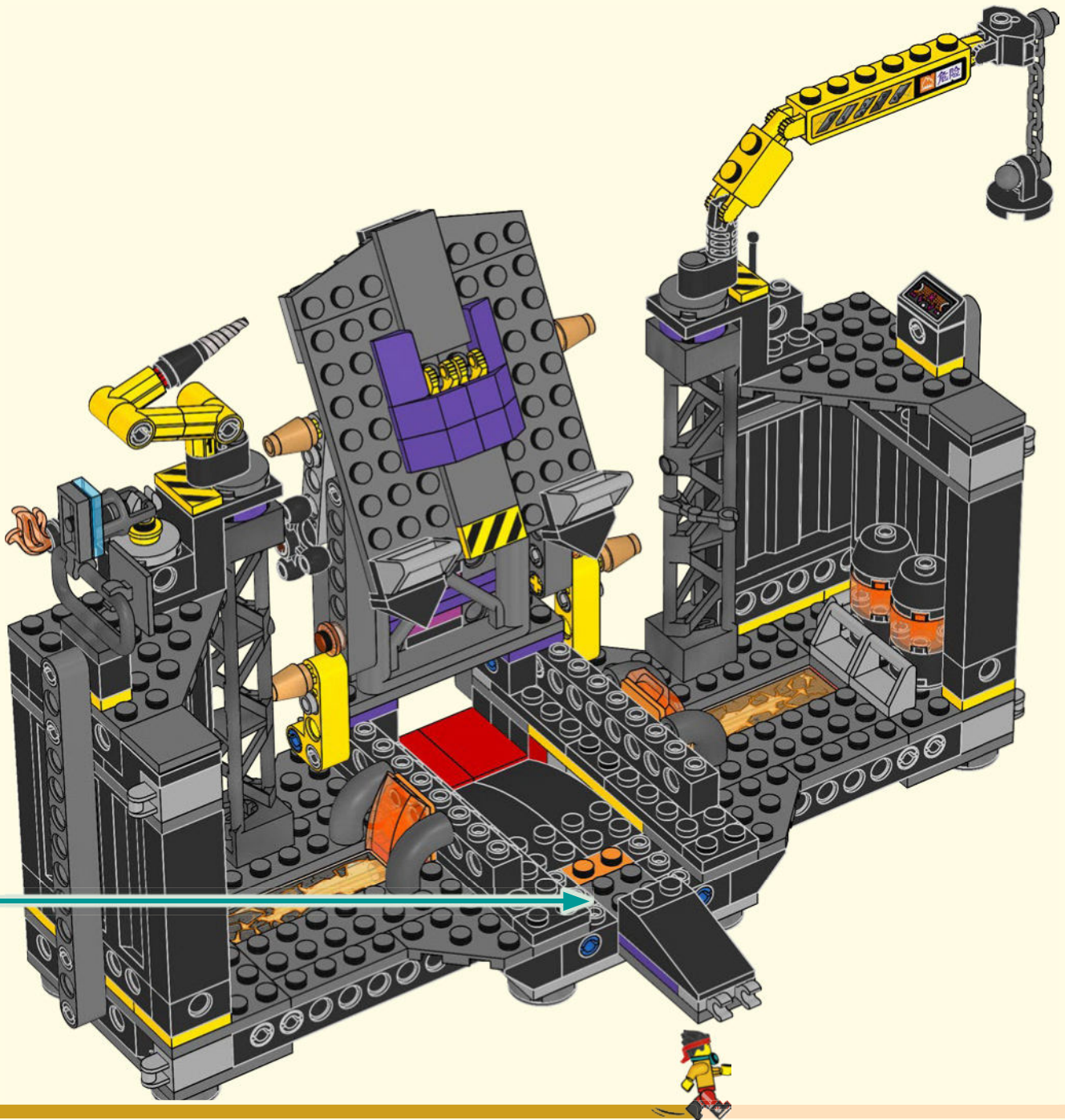
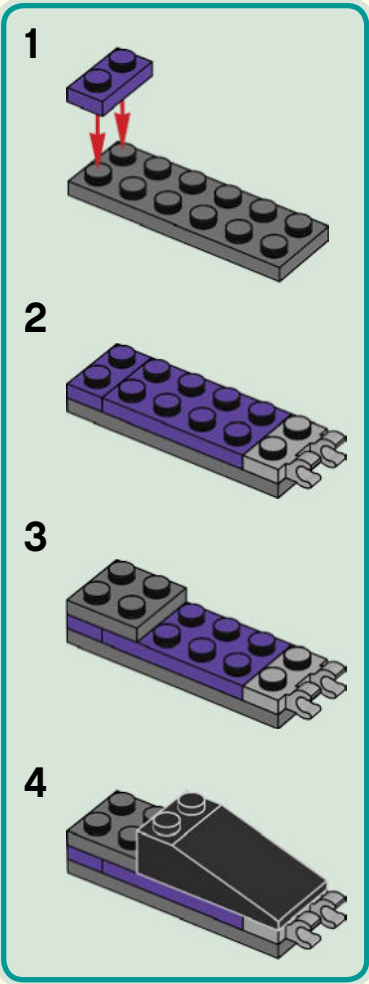

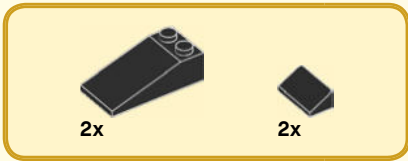

102

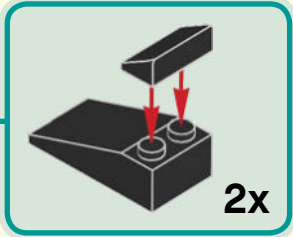
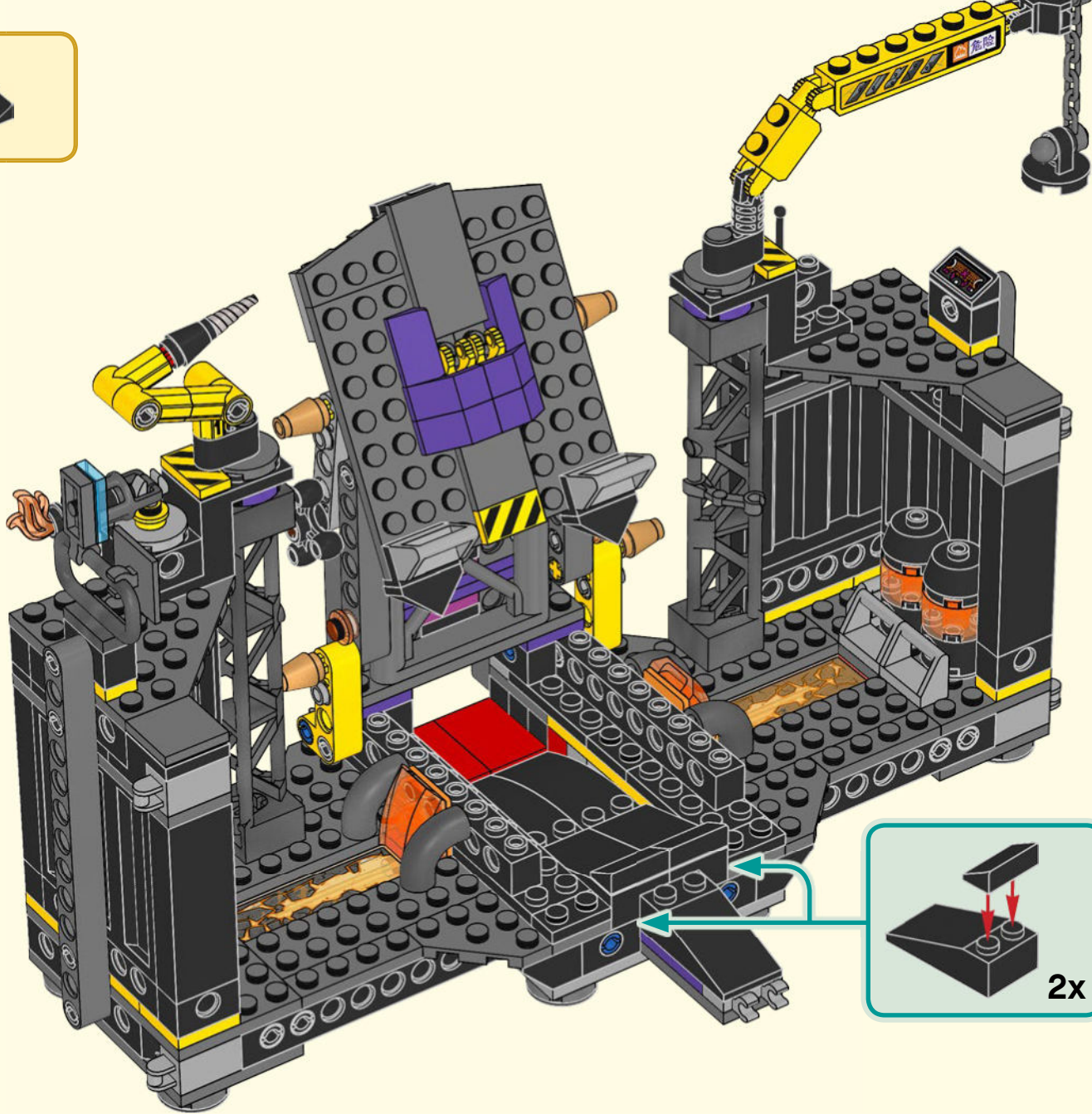

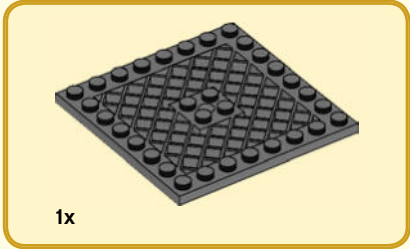

1x

103

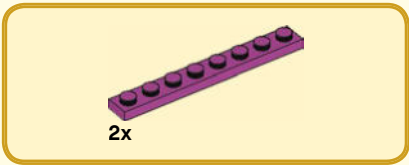
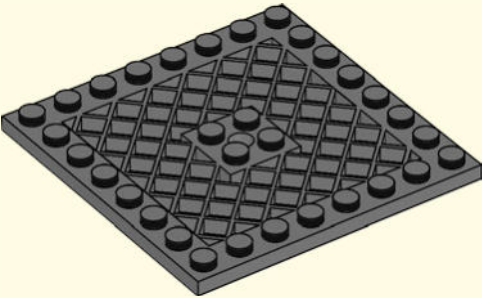

2x

104

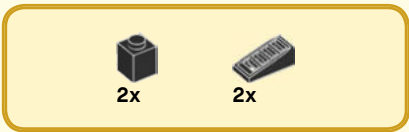
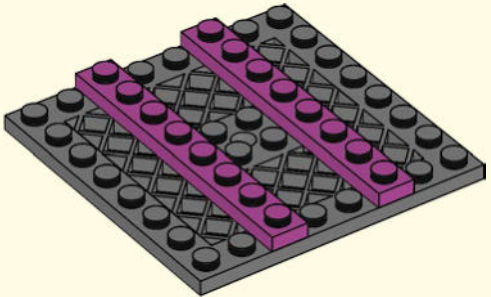

2x

2x

105

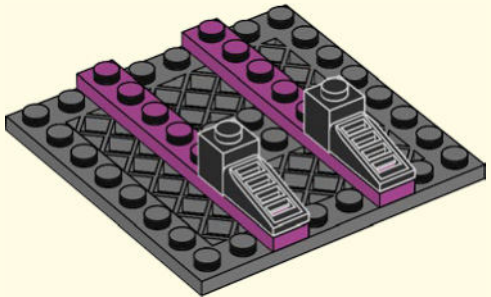



106

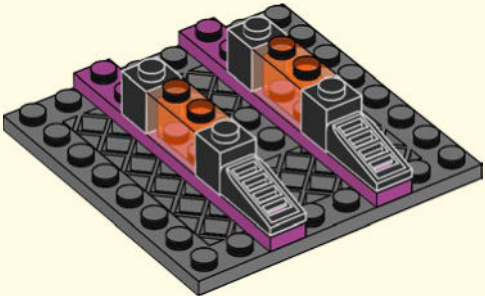

107

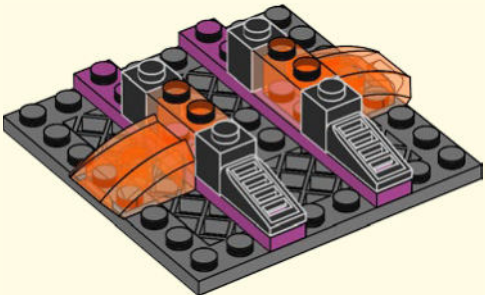

108

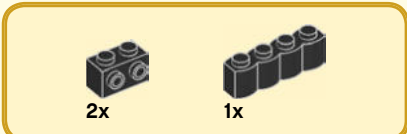
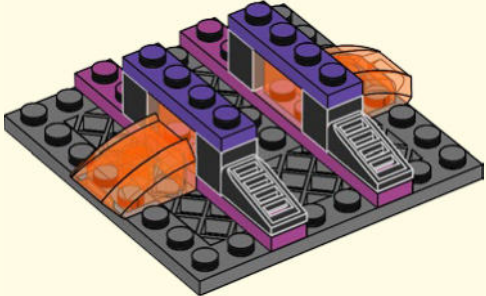

109

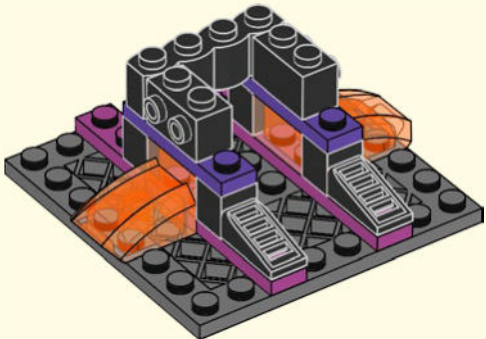

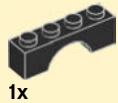

1x

110

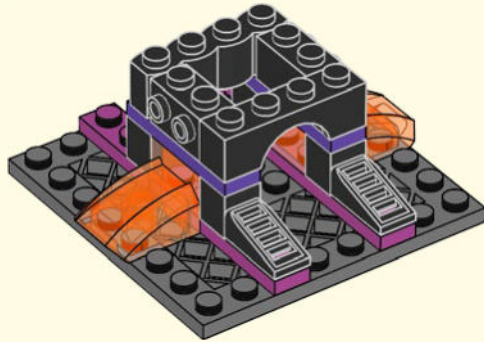

1x

111

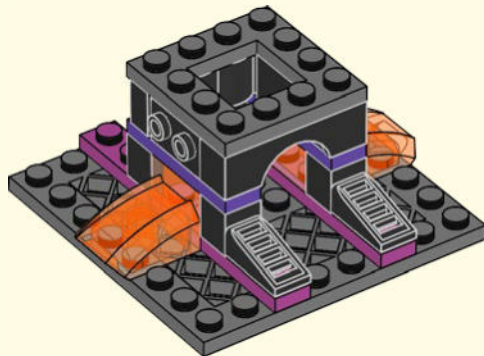

2x

112

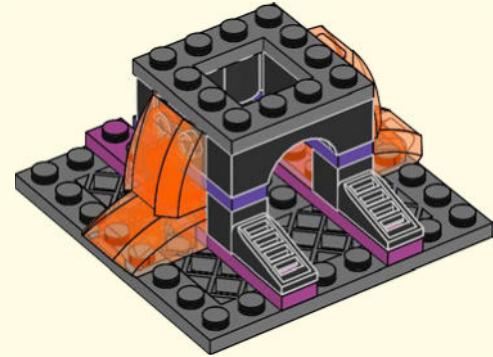

4x

113

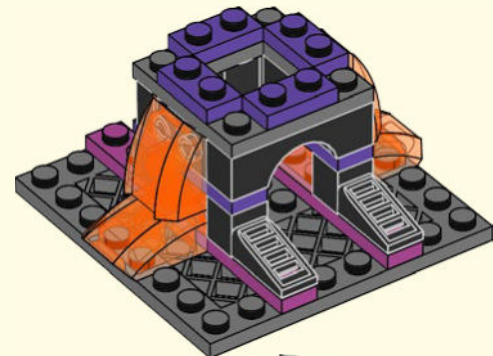



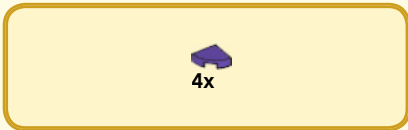

114

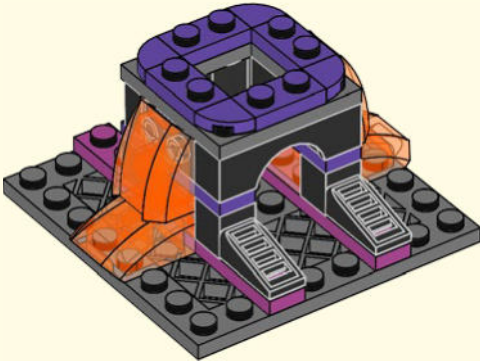

115

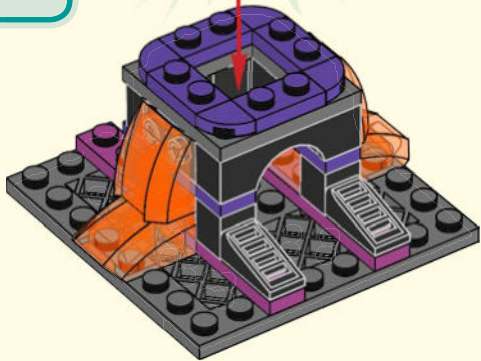
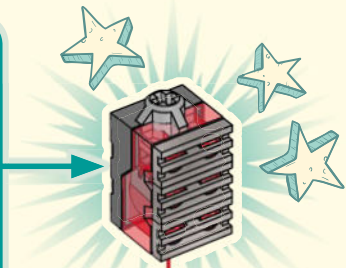
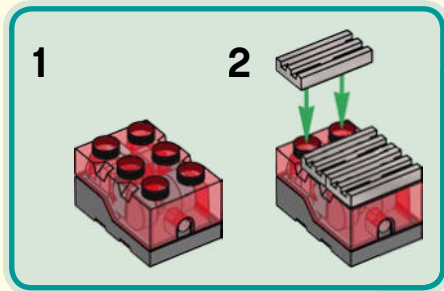



1x



1x

# 116

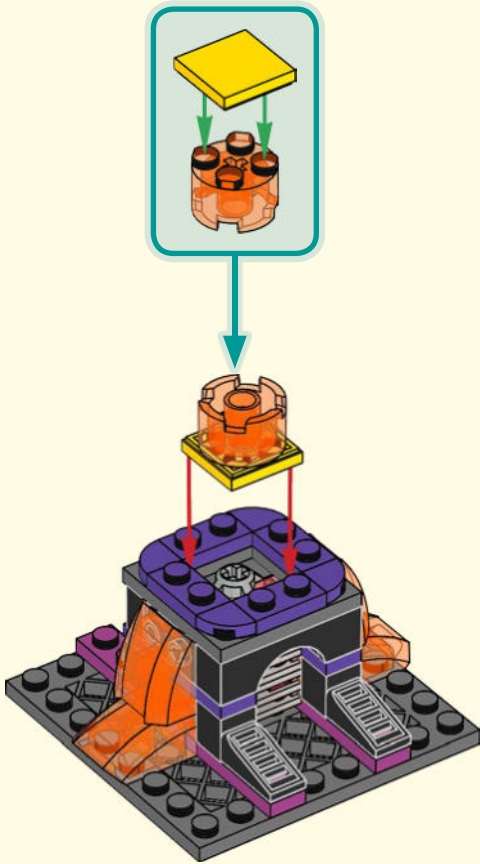

1x

# 117

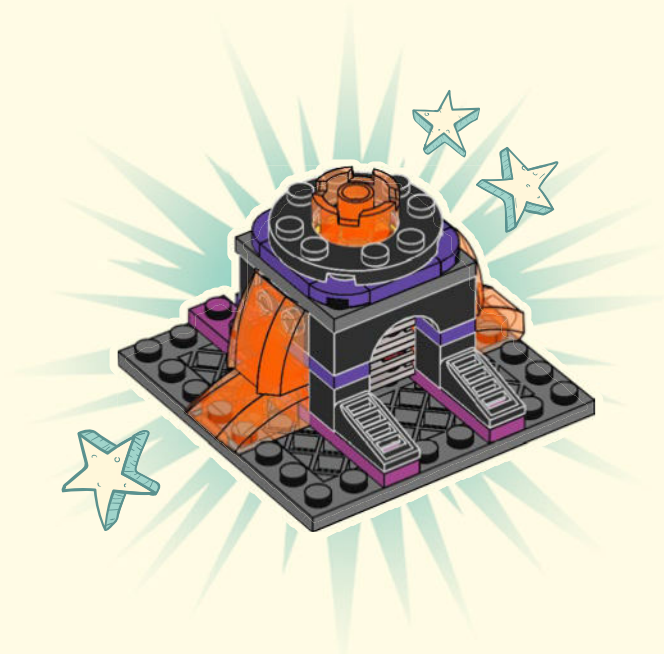

118

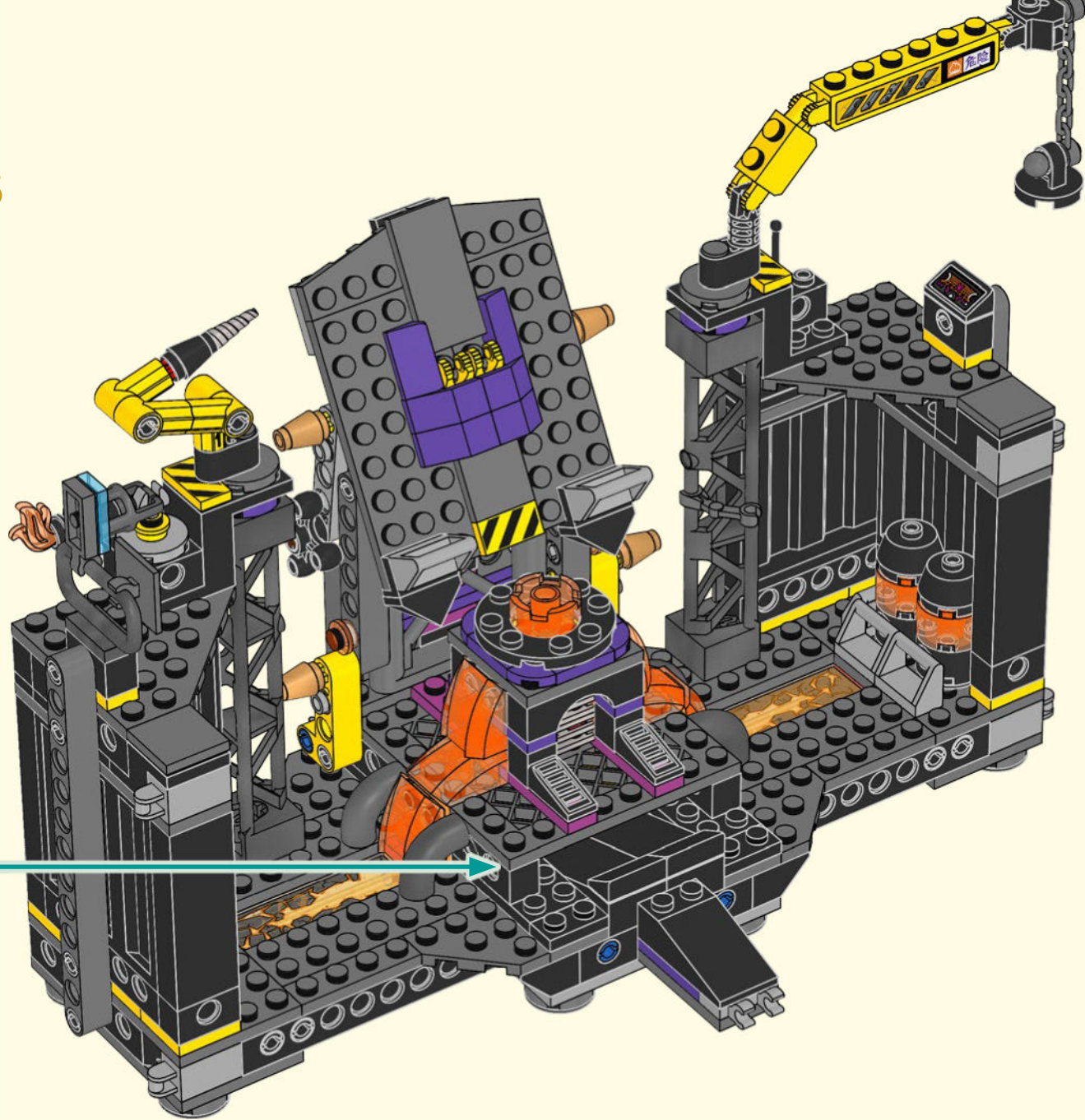



2x

119

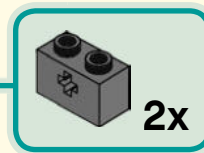
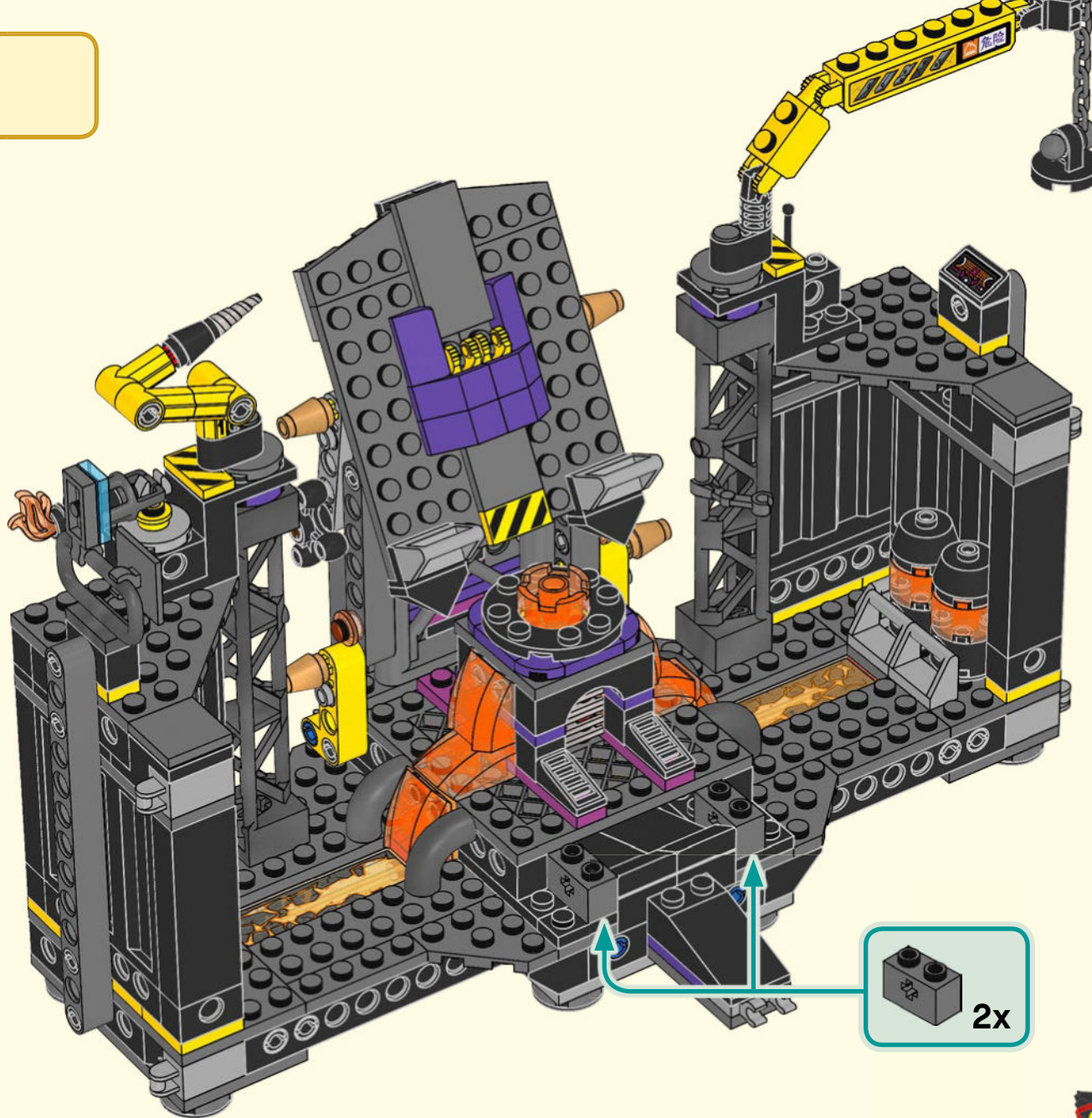

2x





2x

120

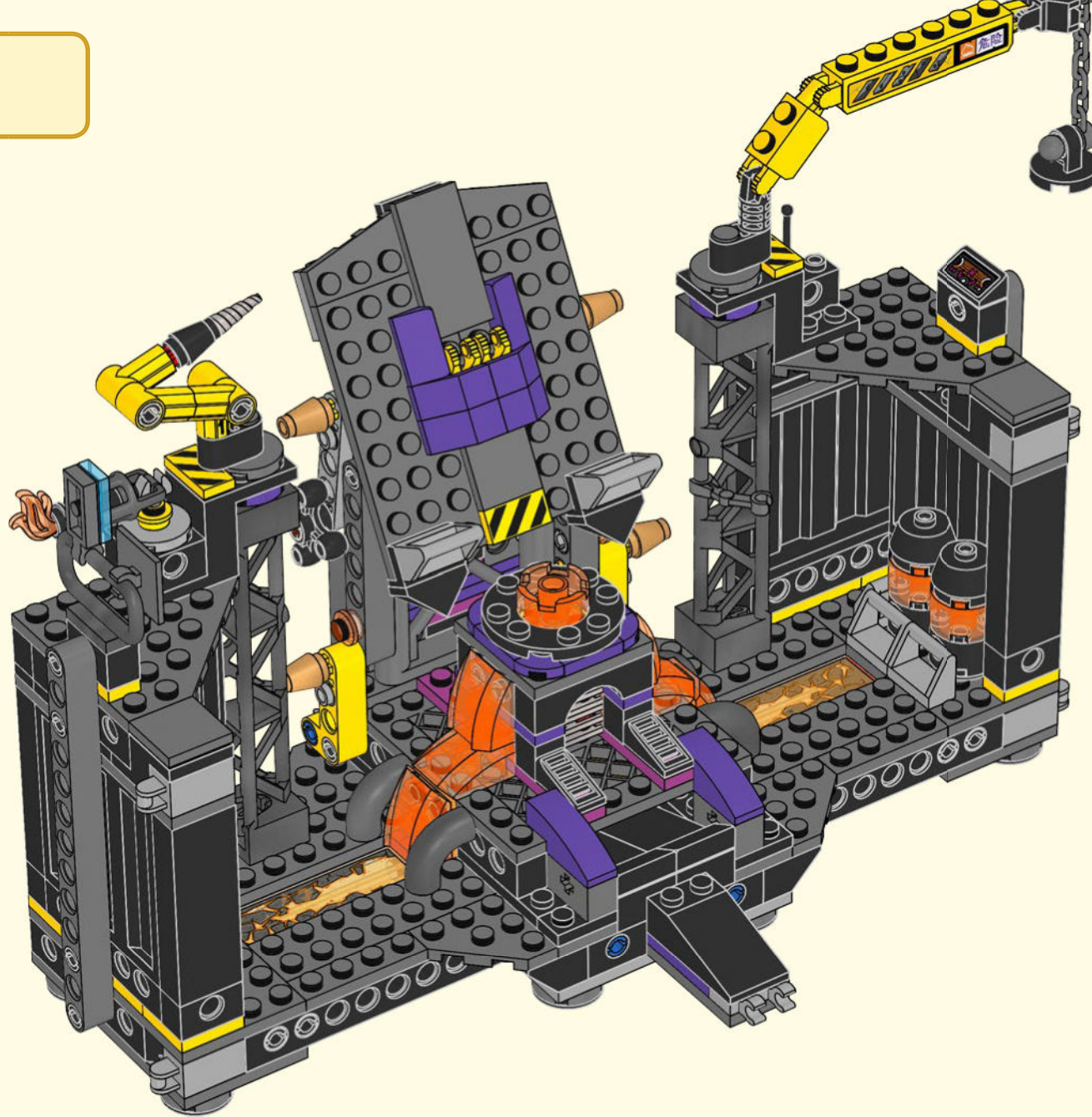



# 121

- 1
- 2
- 3
- 4 2x

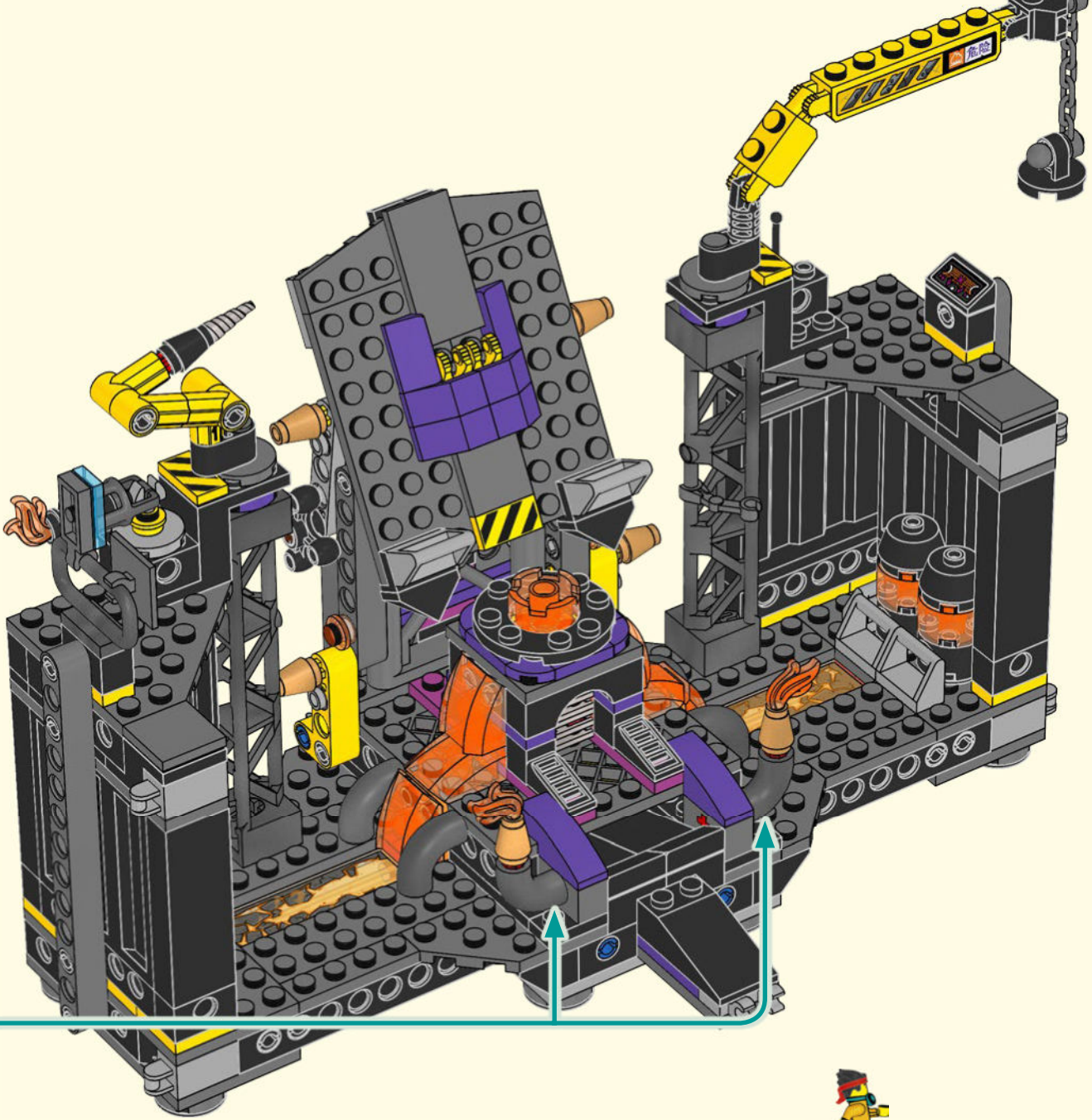

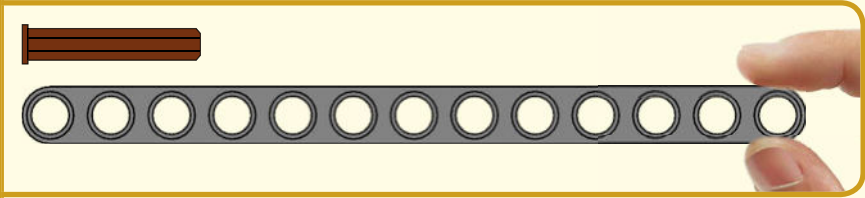
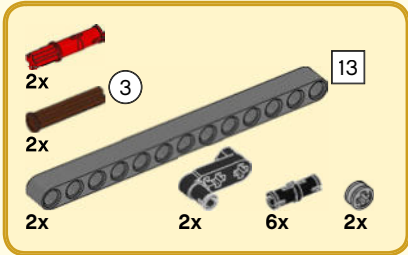

# 122

1

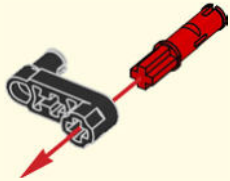

2

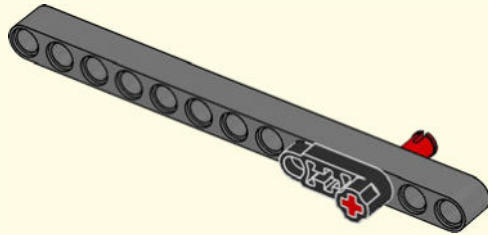

3

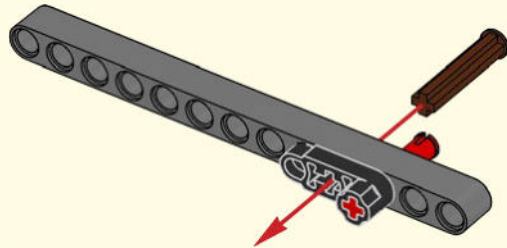

4

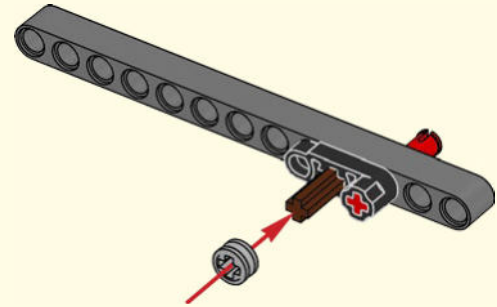

5

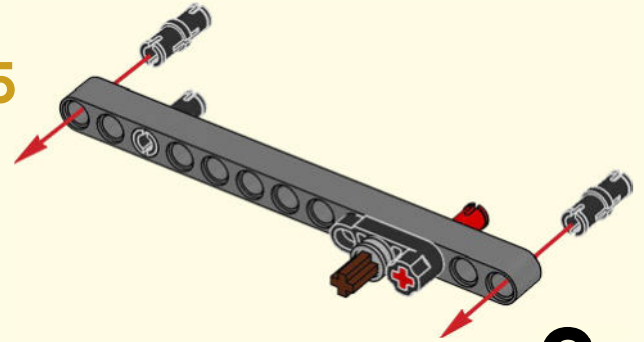

2x

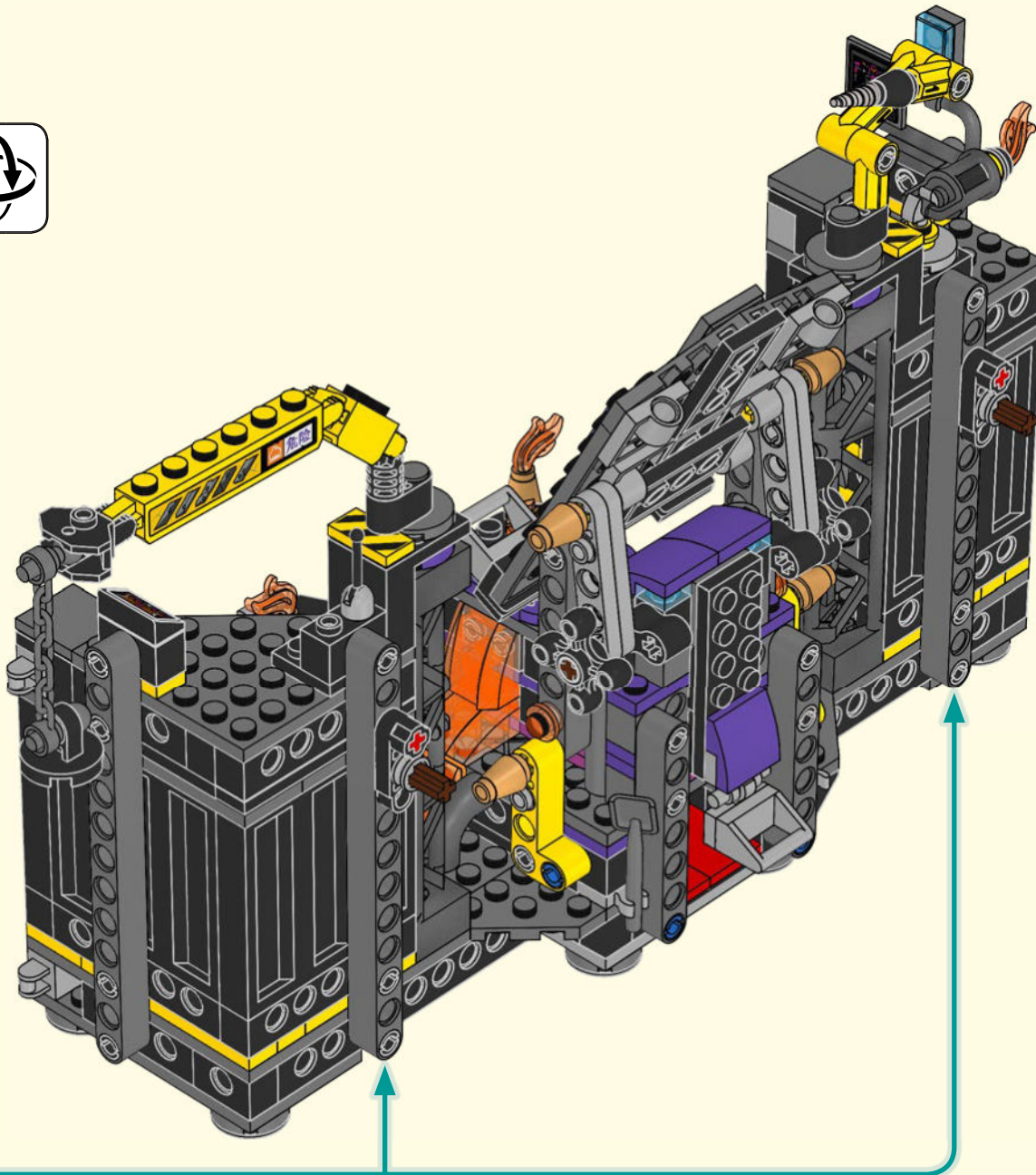



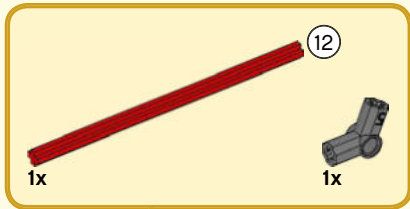

123

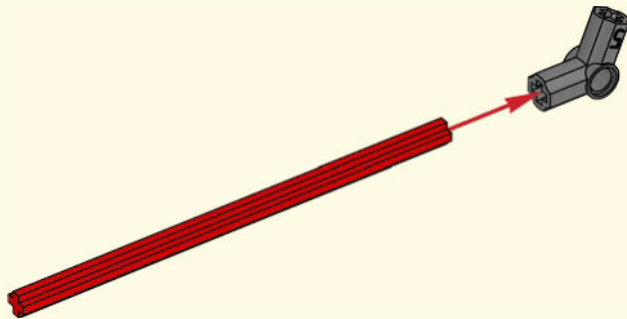
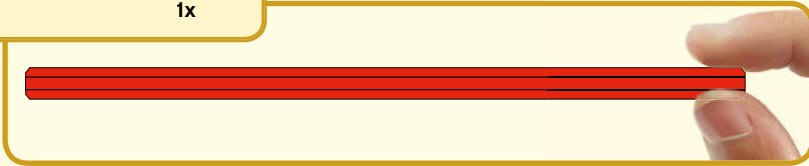

124

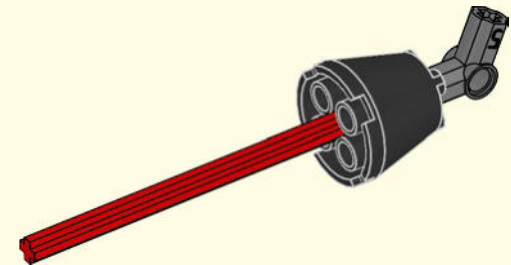

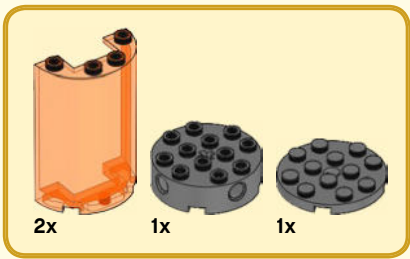

125

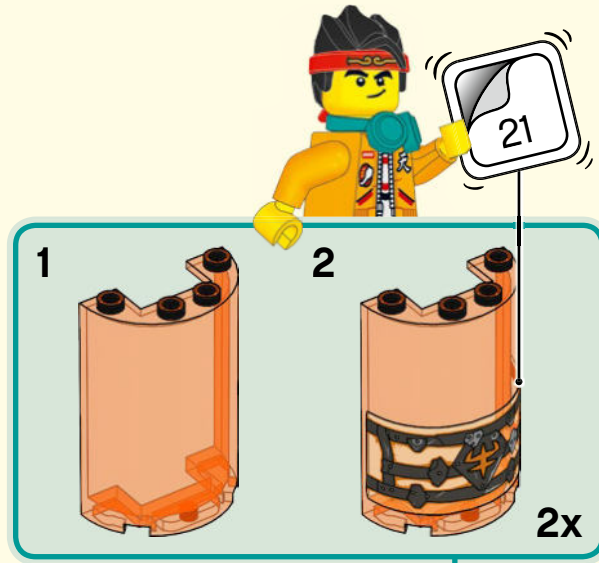

1



2



3



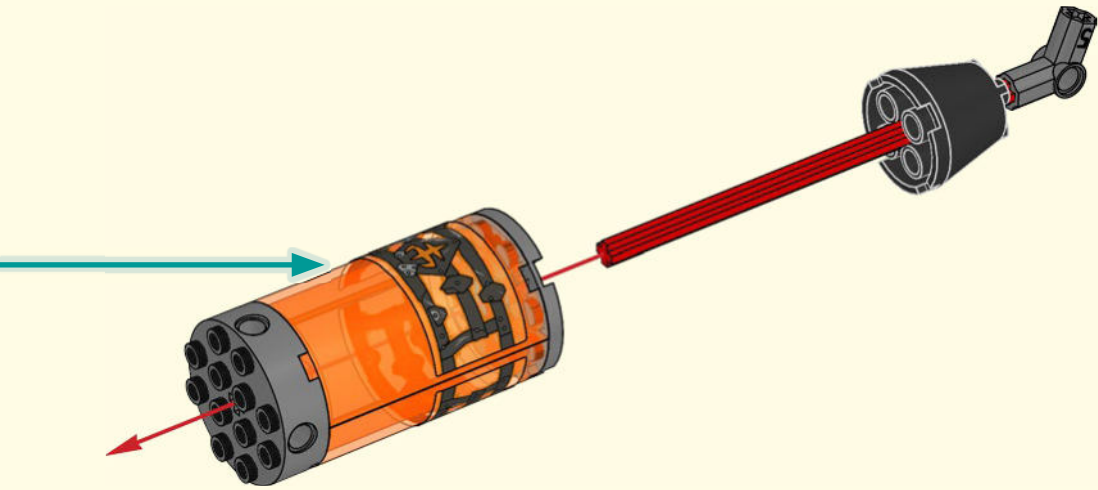

126

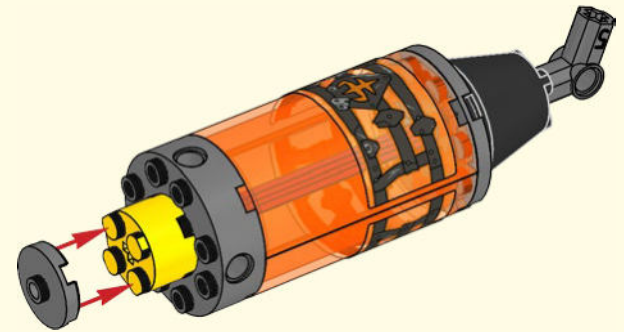

127

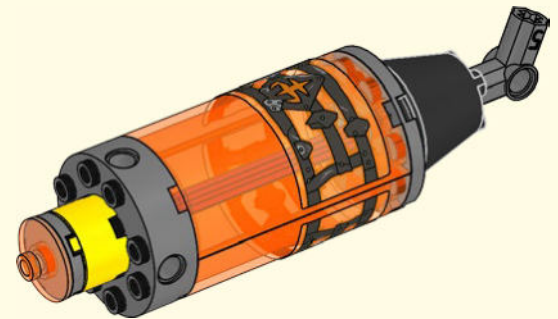



128

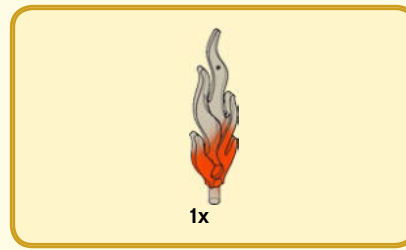
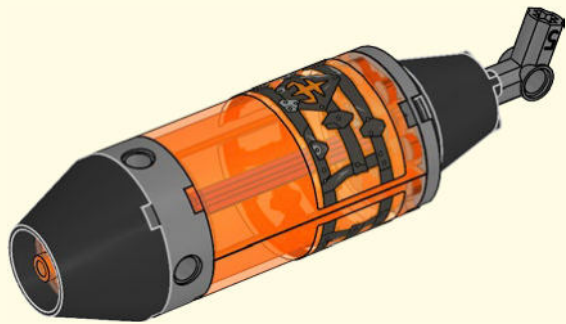

129

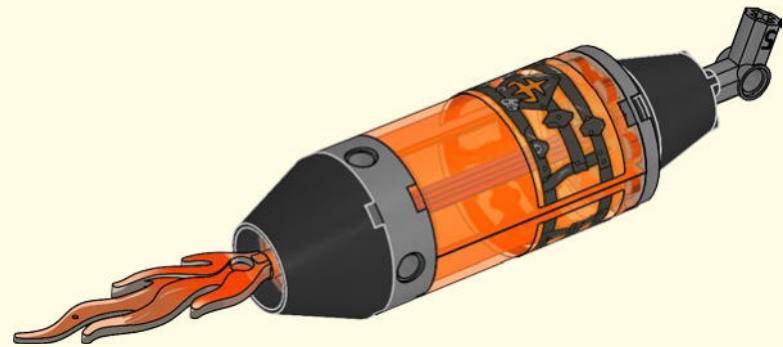

2x



130

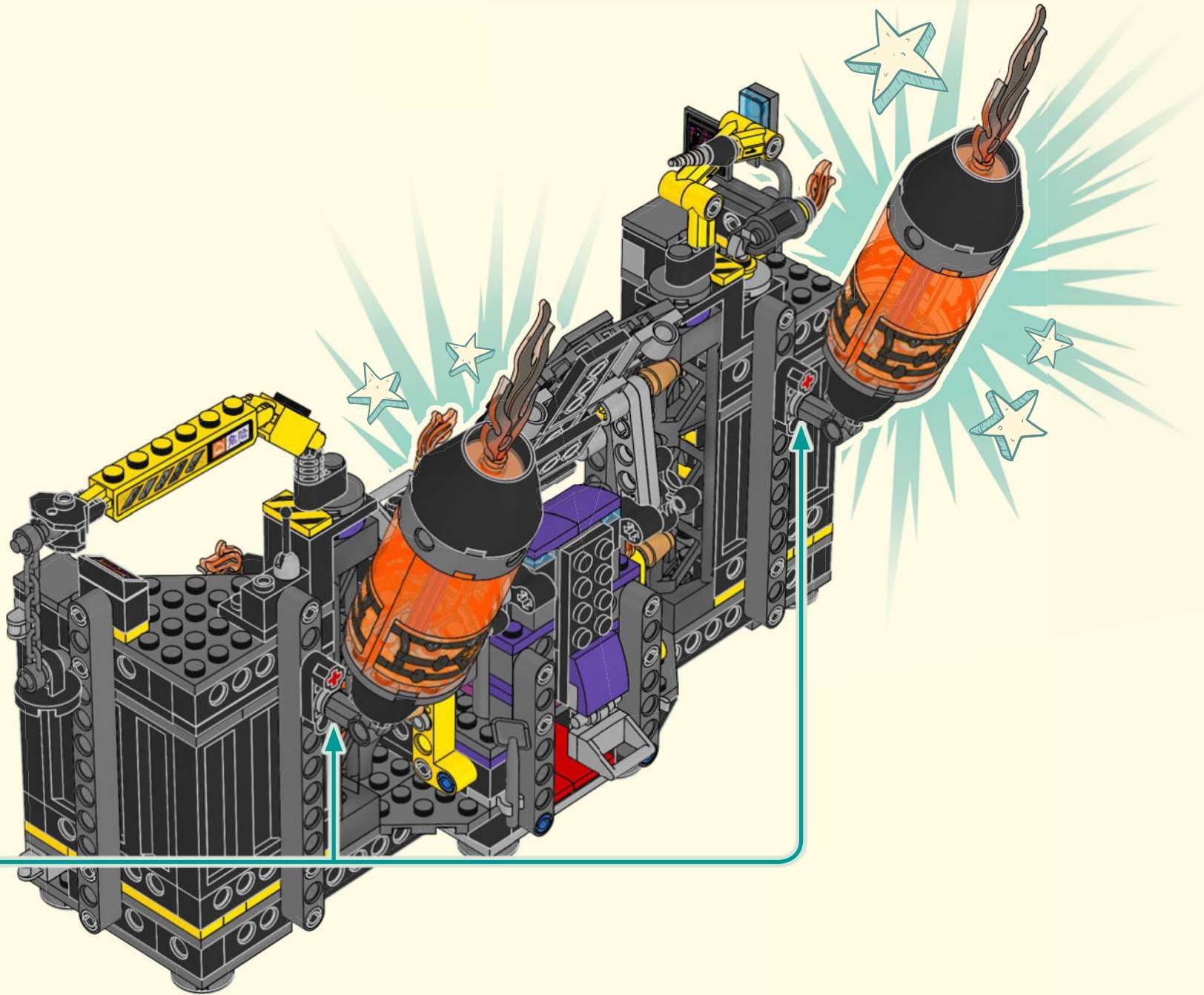



1x

131

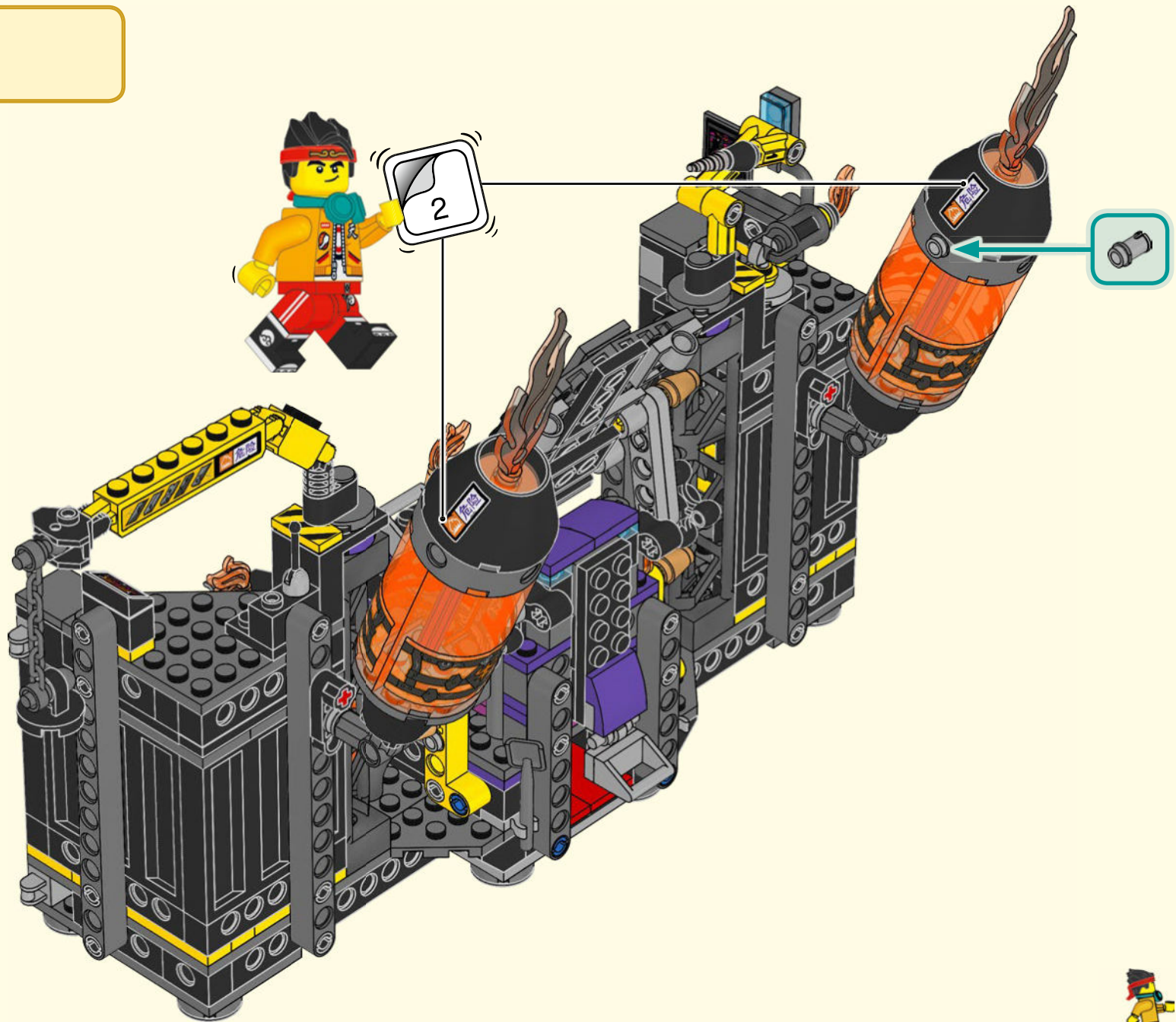

1x

132

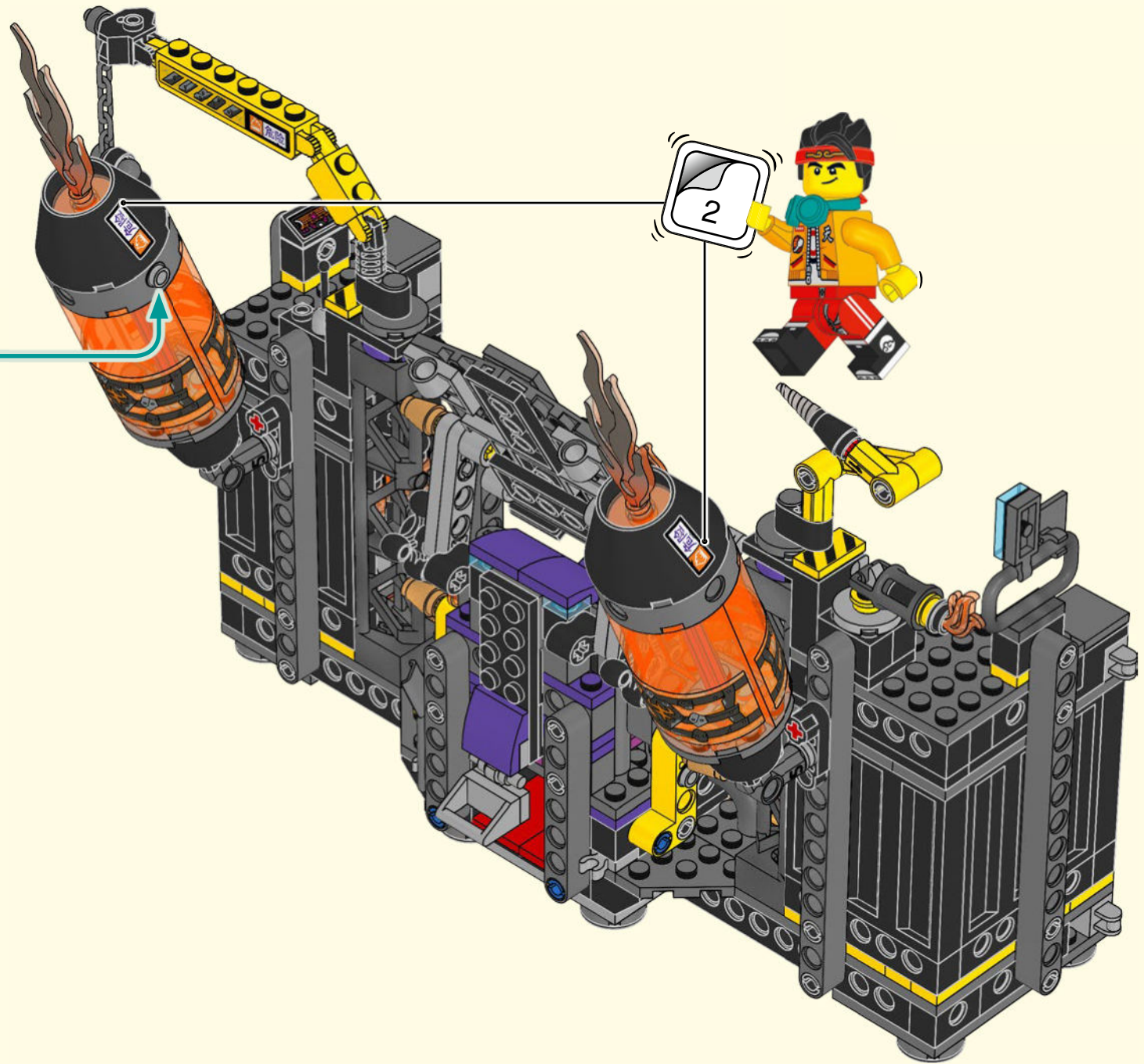

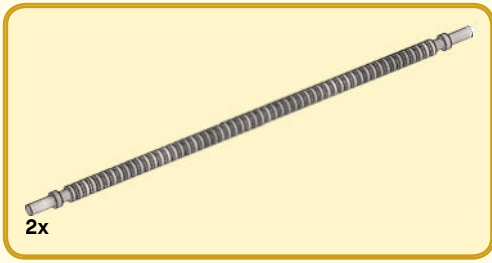

133

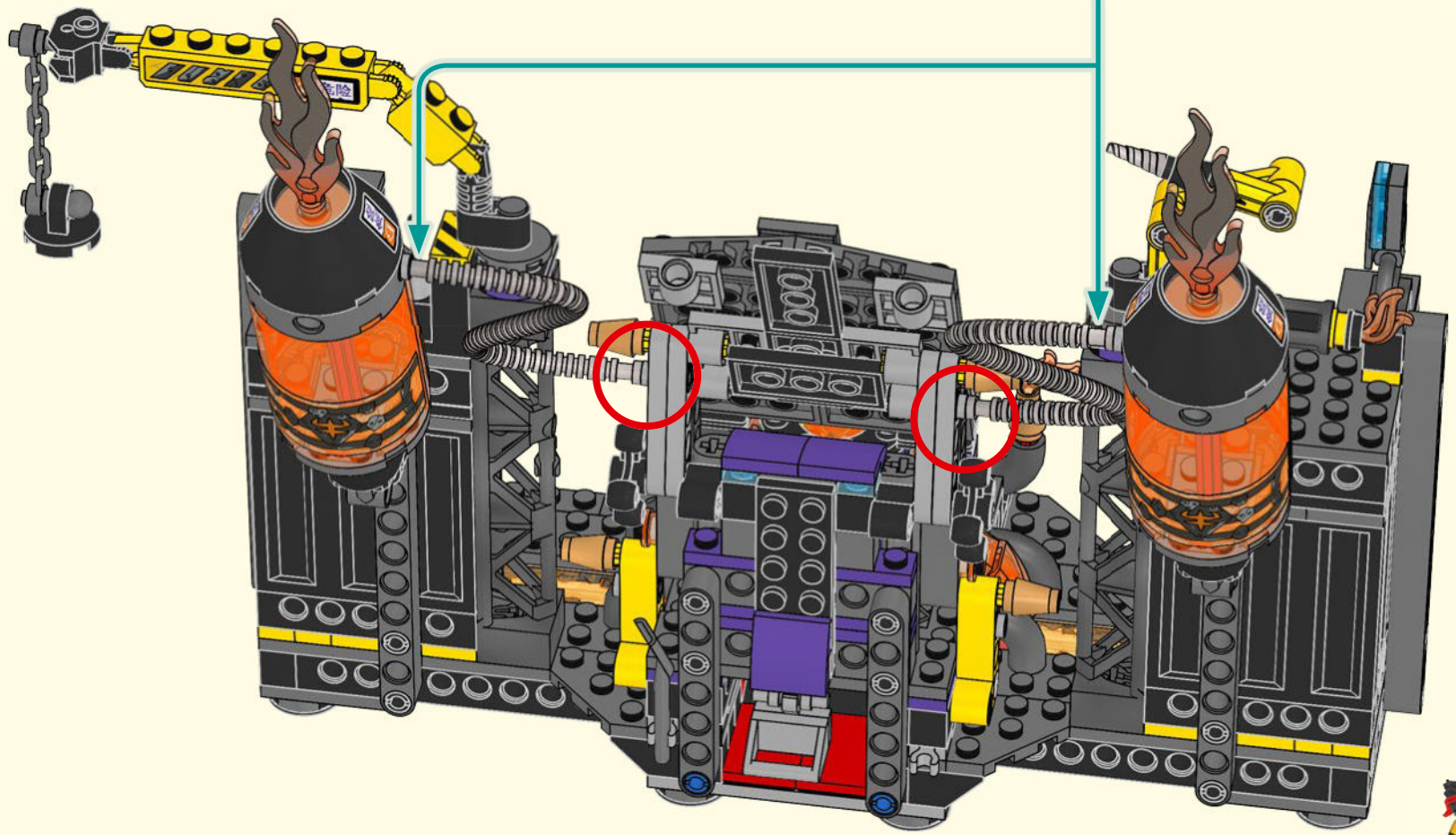
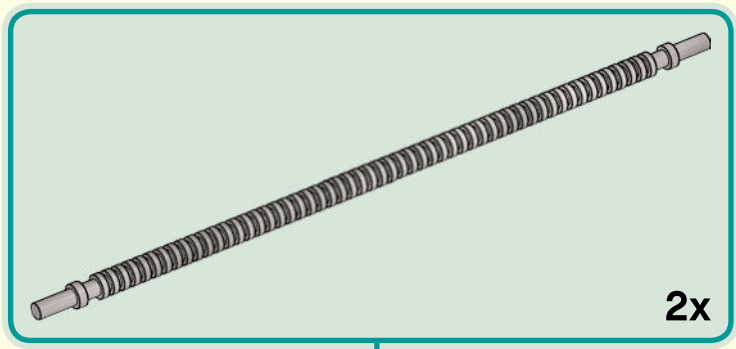



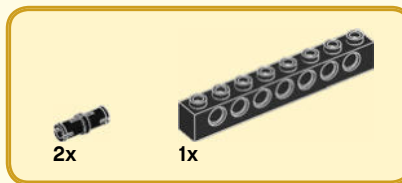

134

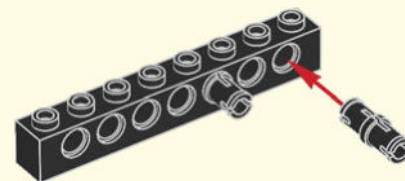

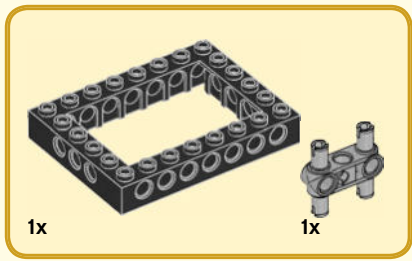

135

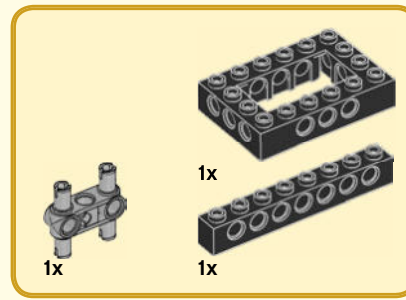
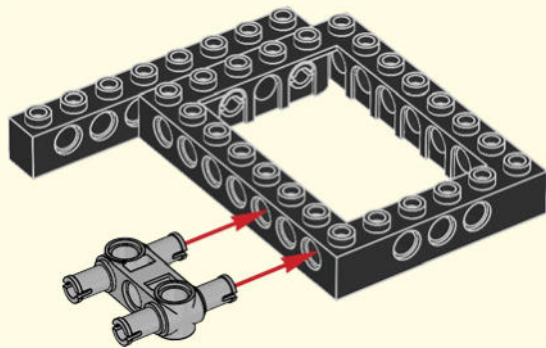

136

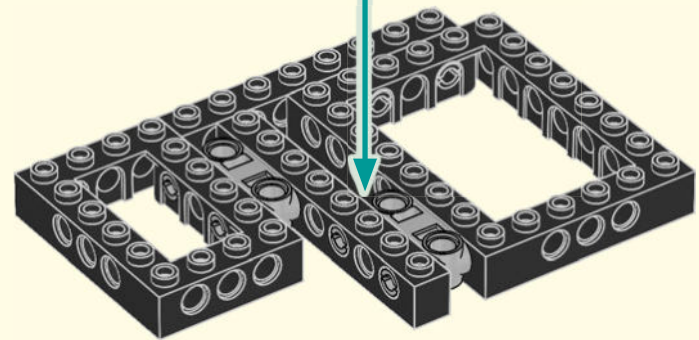
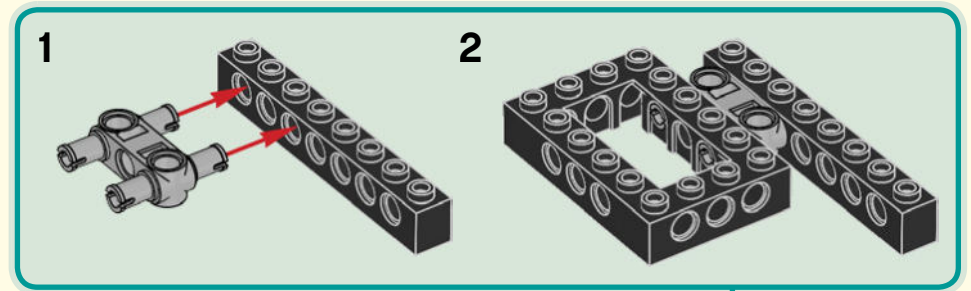

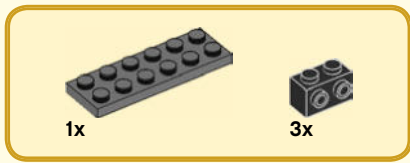

137

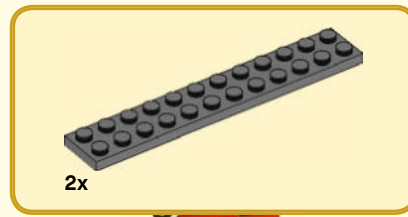
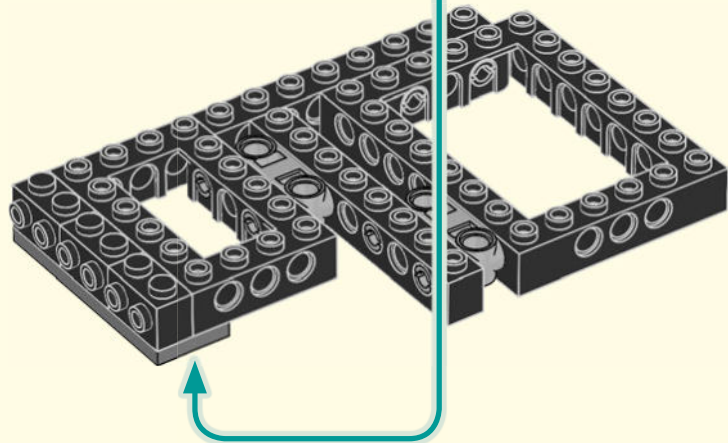
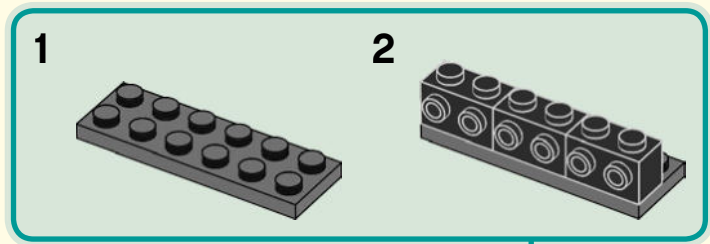

138

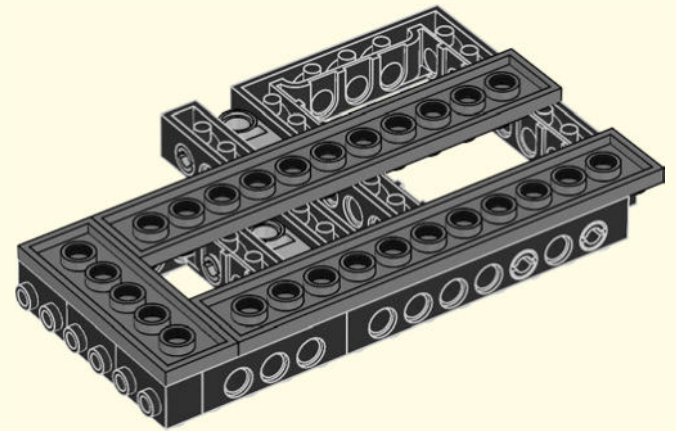

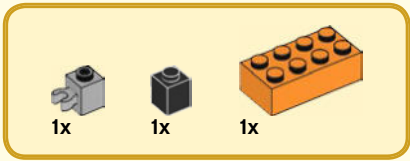

# 139

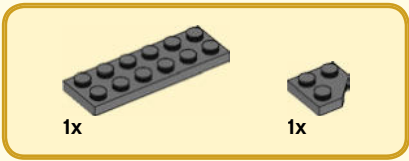
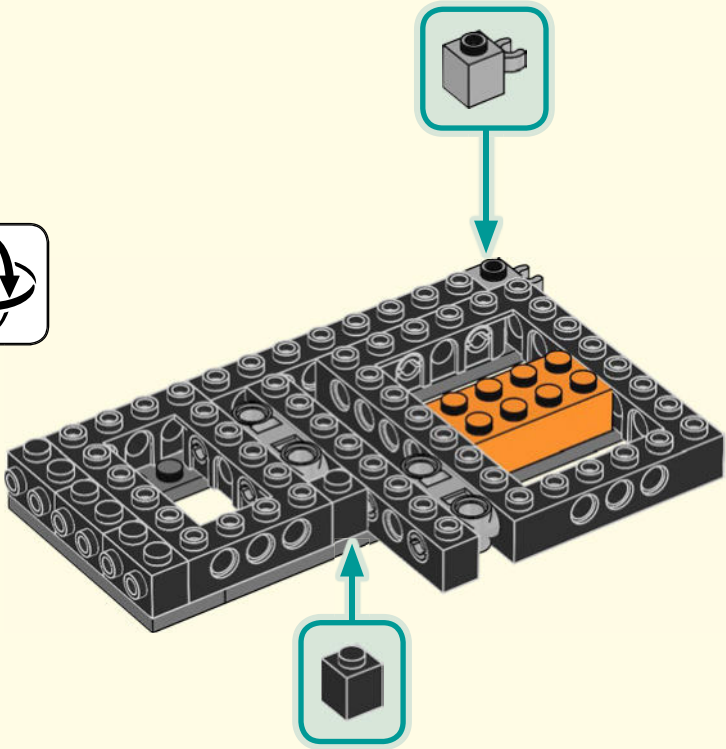

# 140

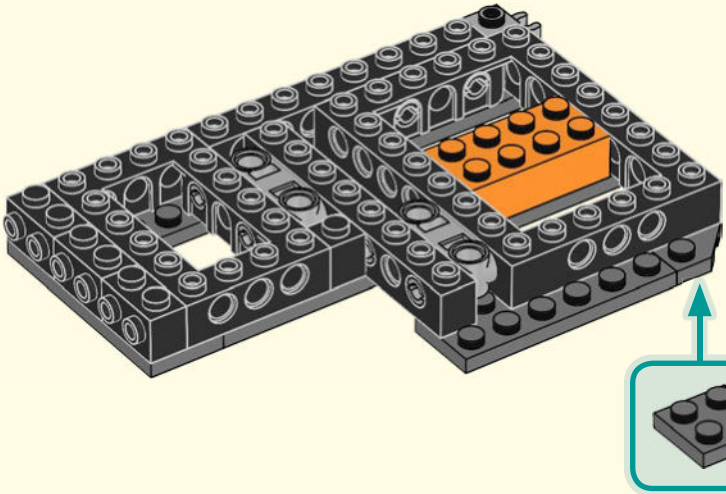

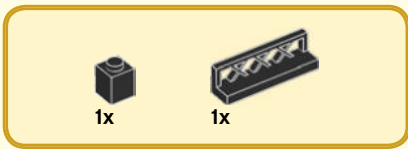

141

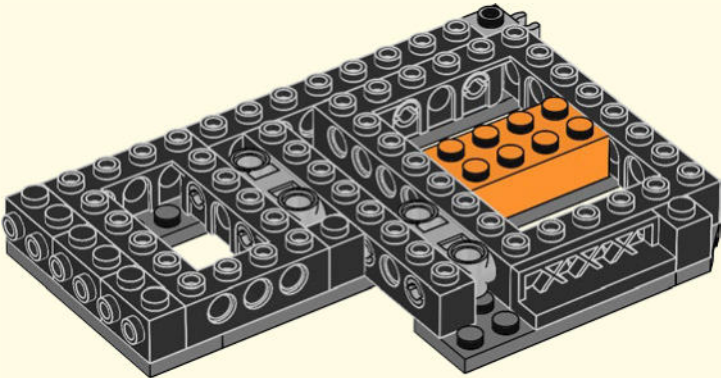

142

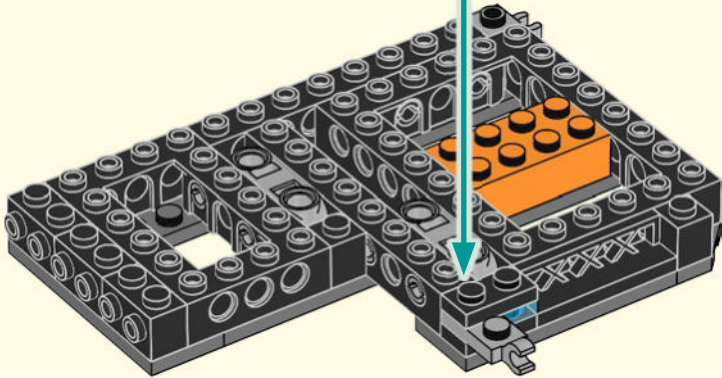
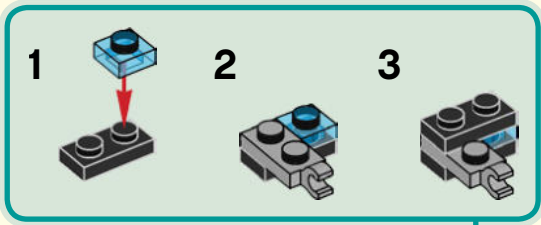

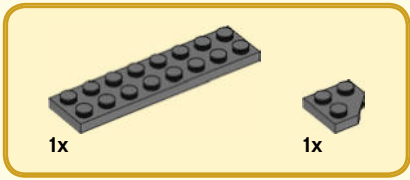

# 143

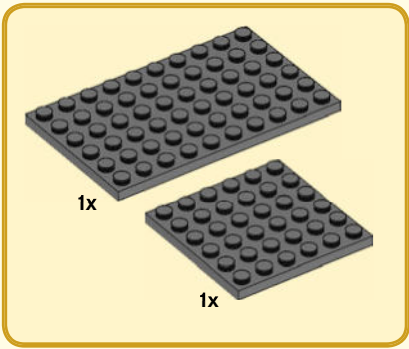
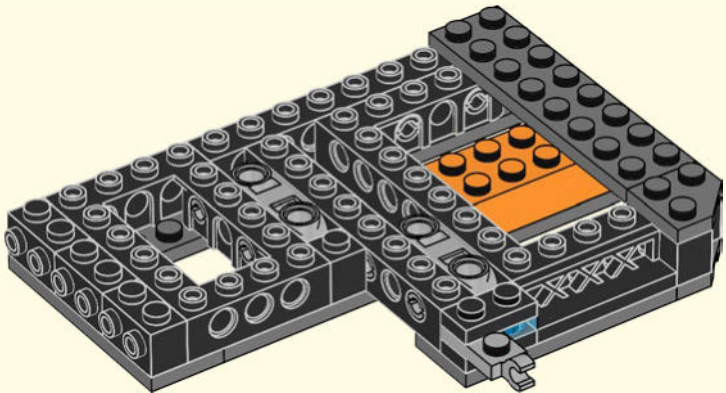

# 144

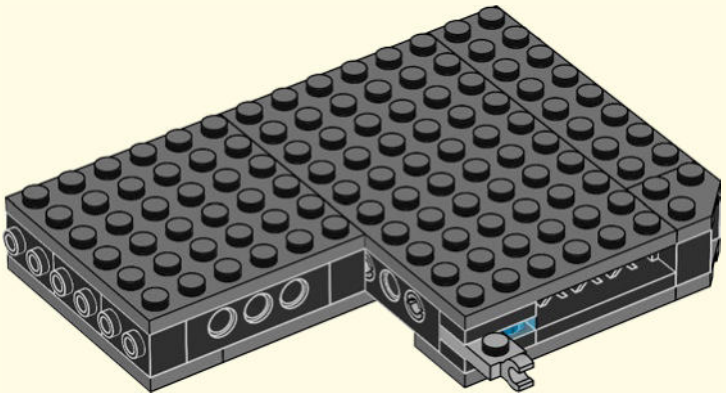



145

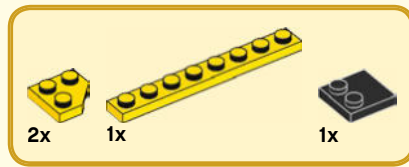
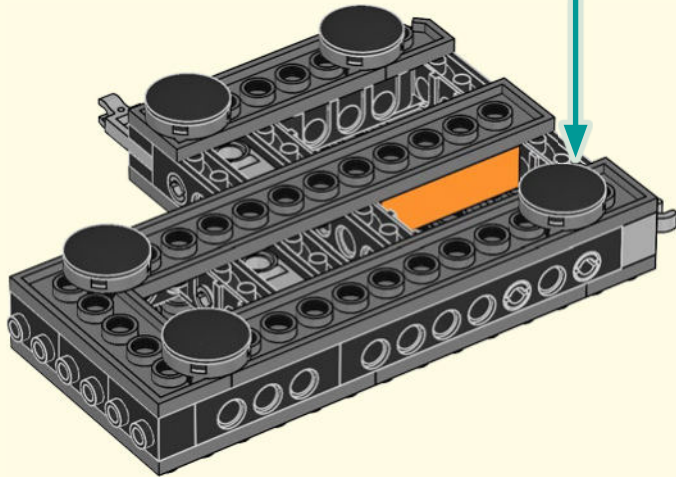
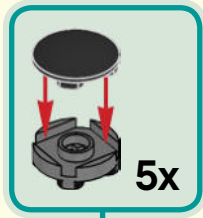

146

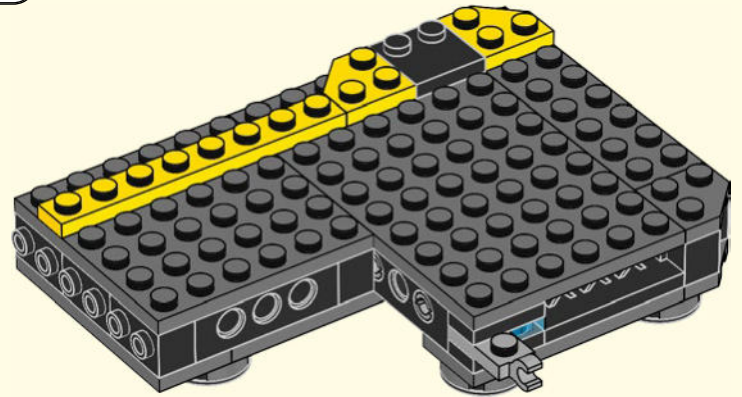
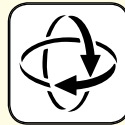

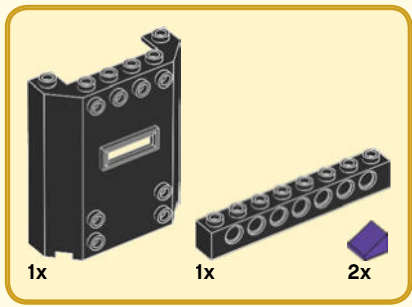

147

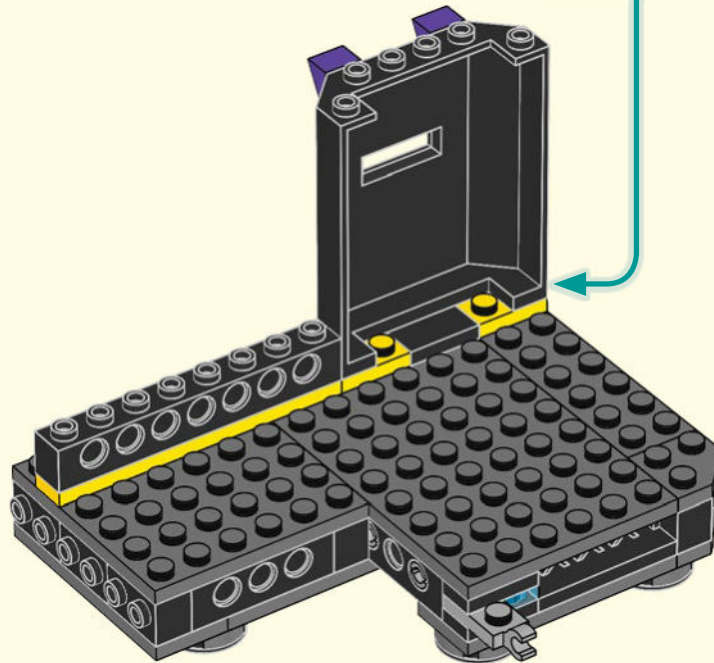
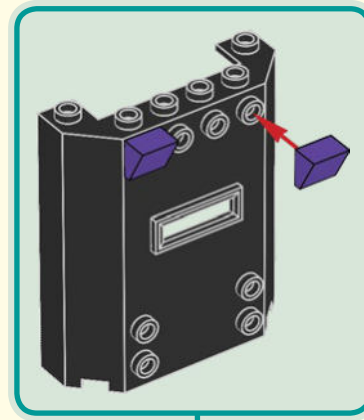



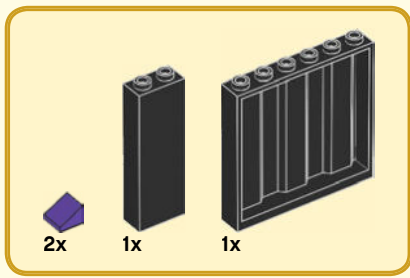

148

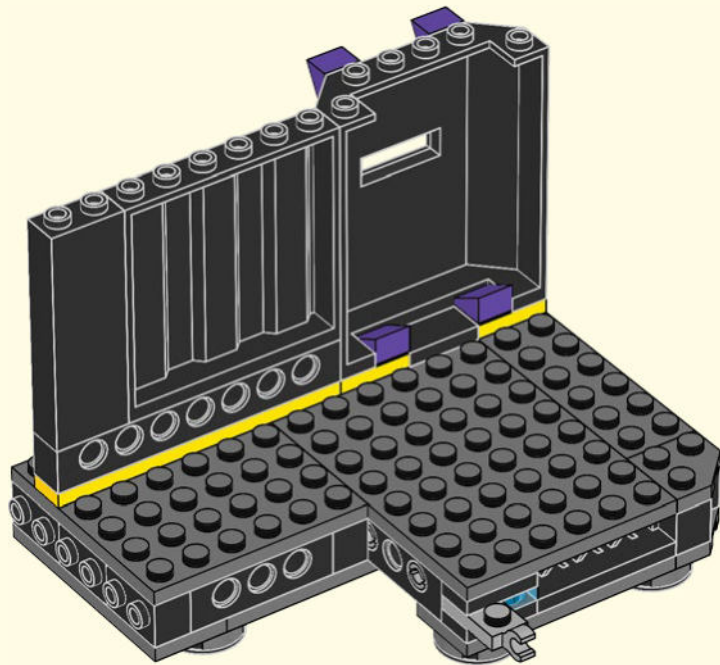

149

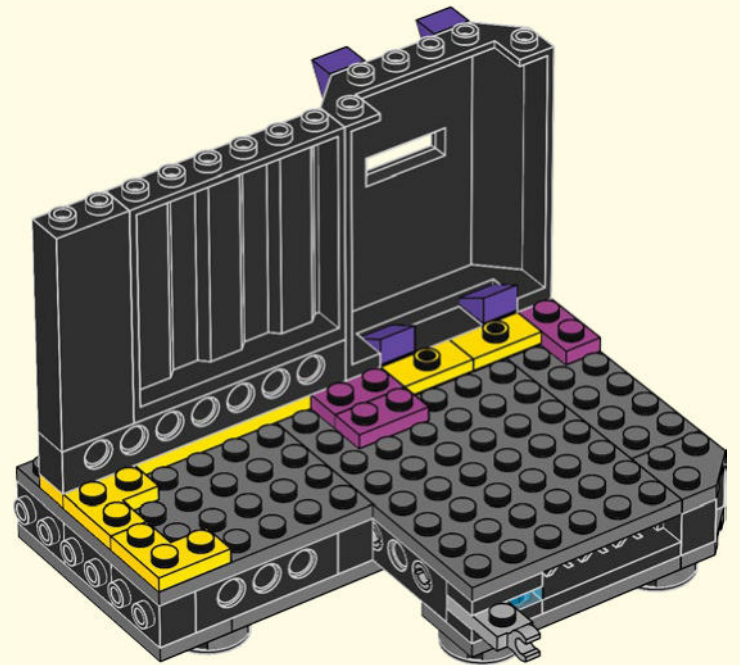

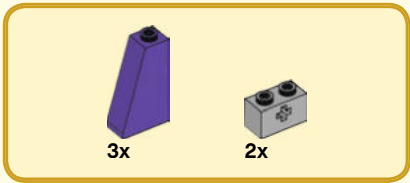

150

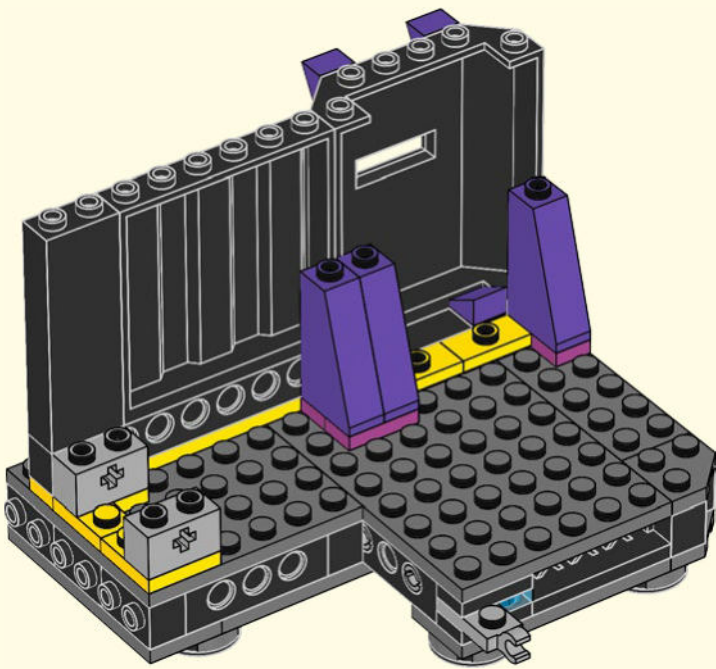

151

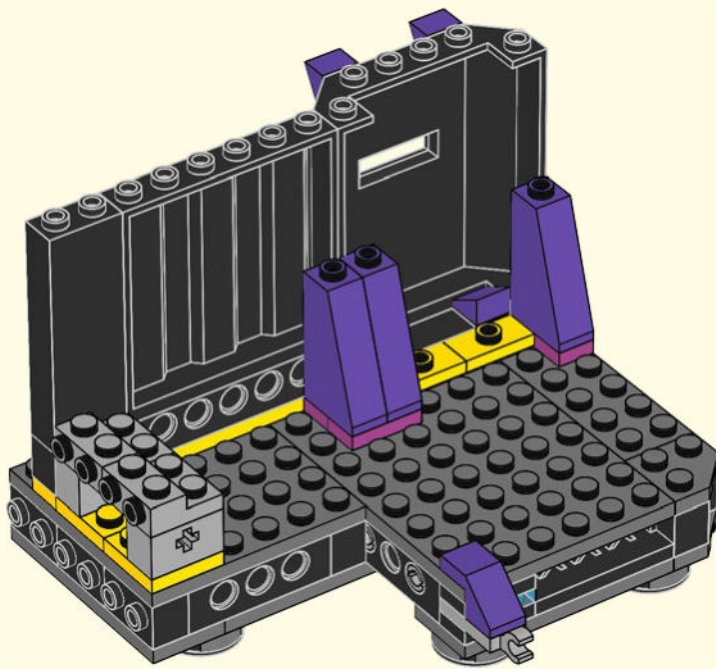



152

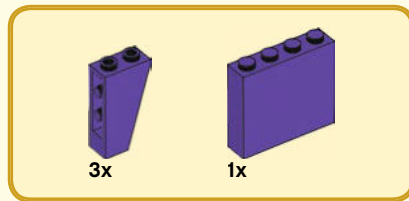
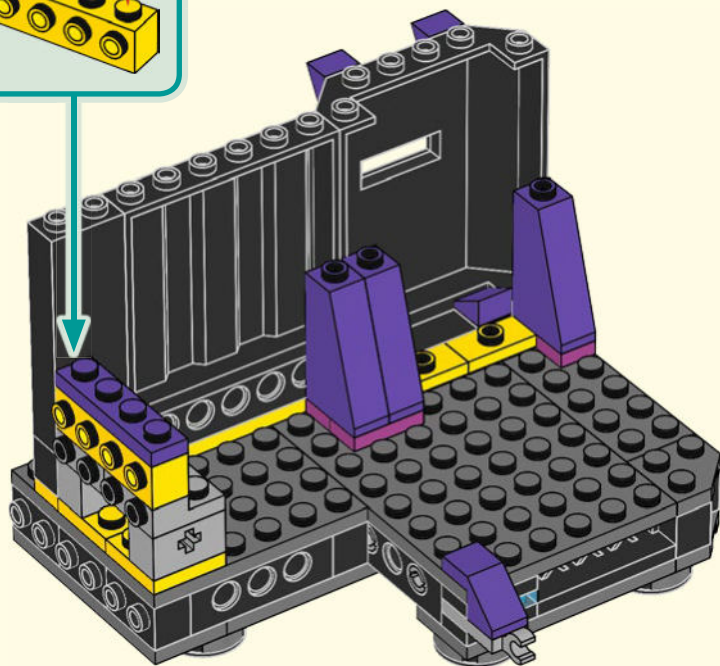
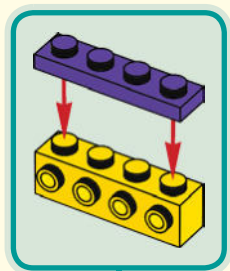

153

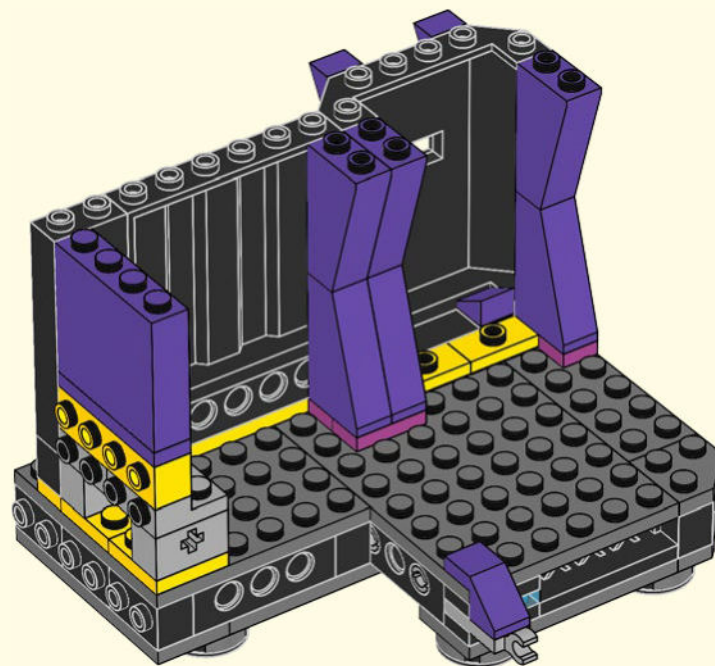

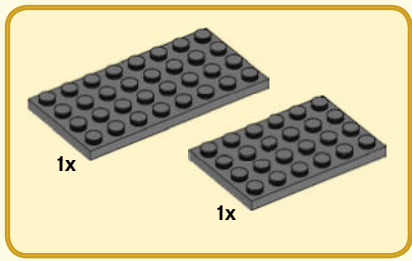

154

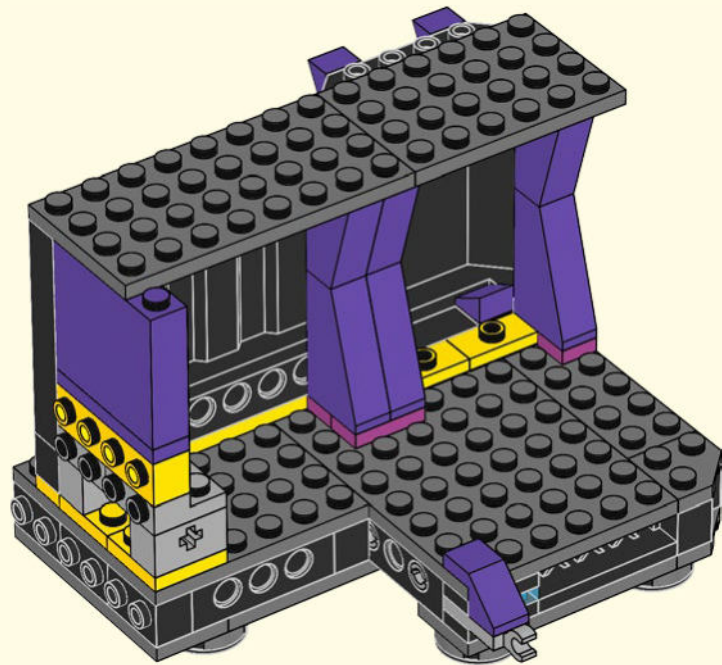

155

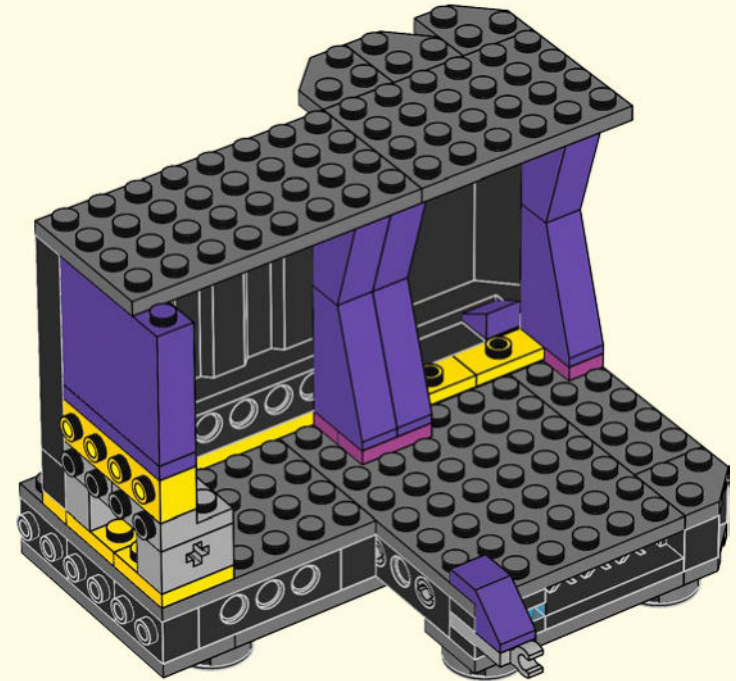

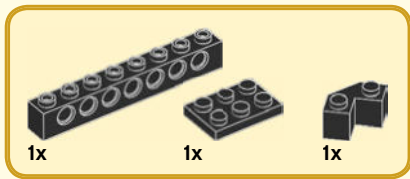

156

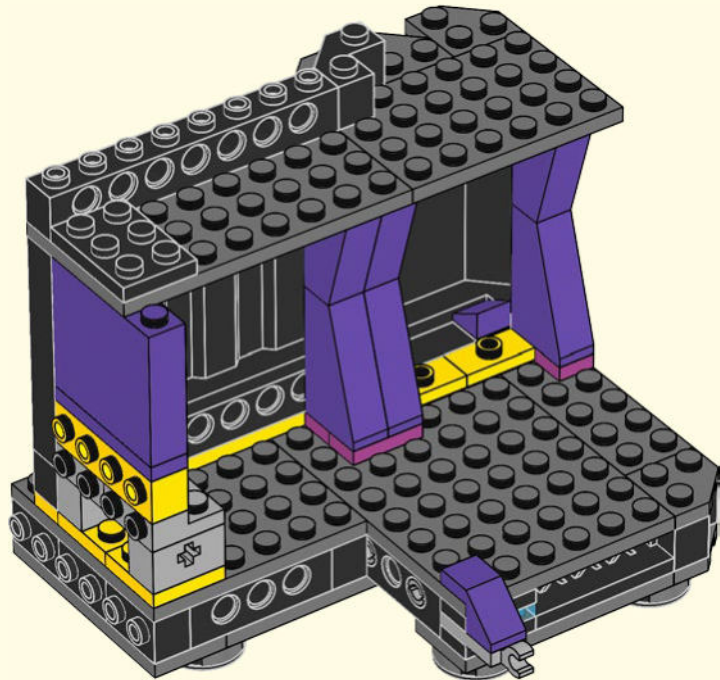

157

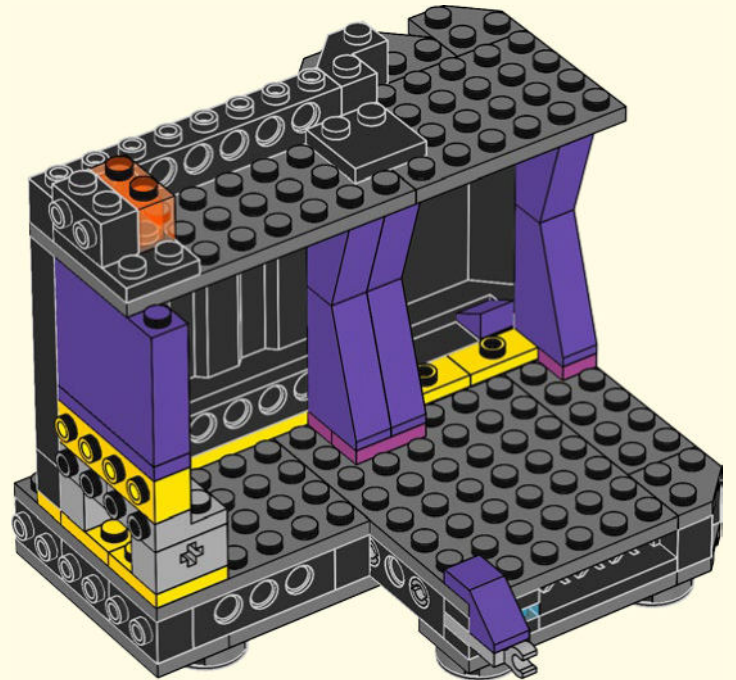



1x



1x

# 158

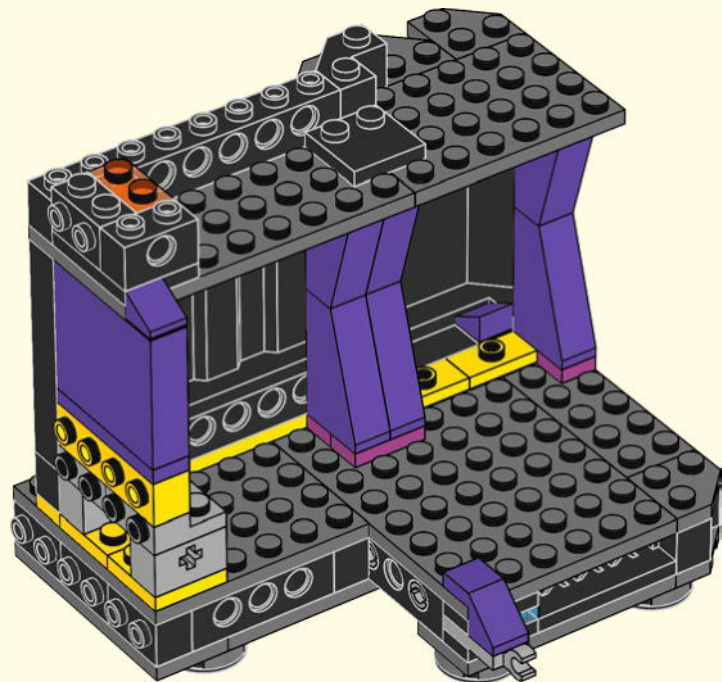

1x



1x



1x

# 159

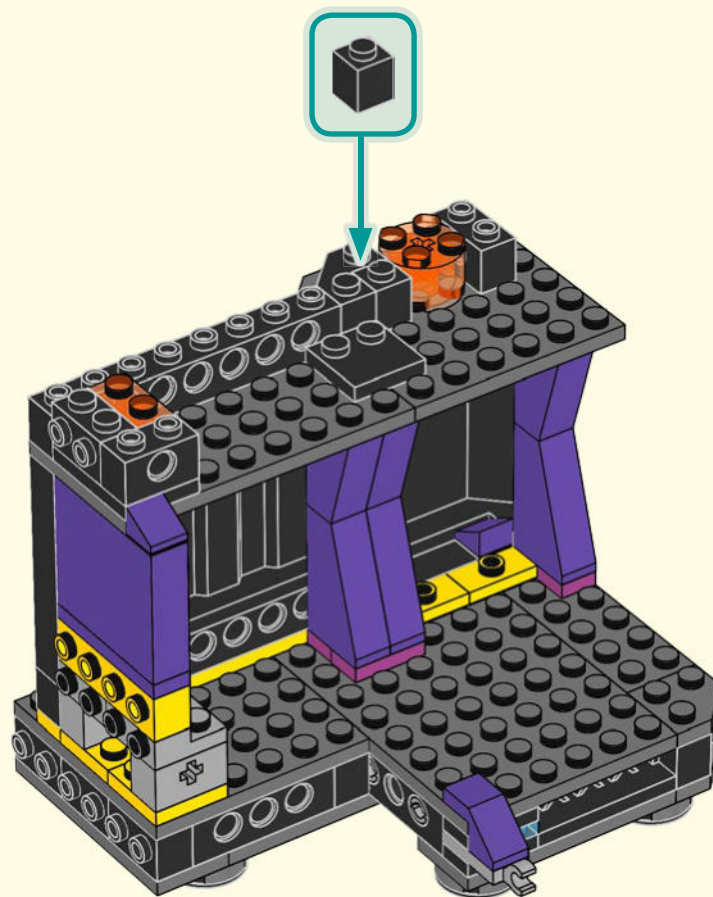



160

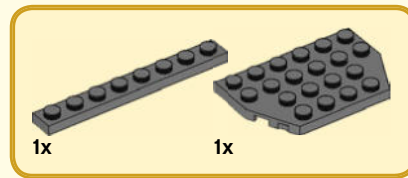
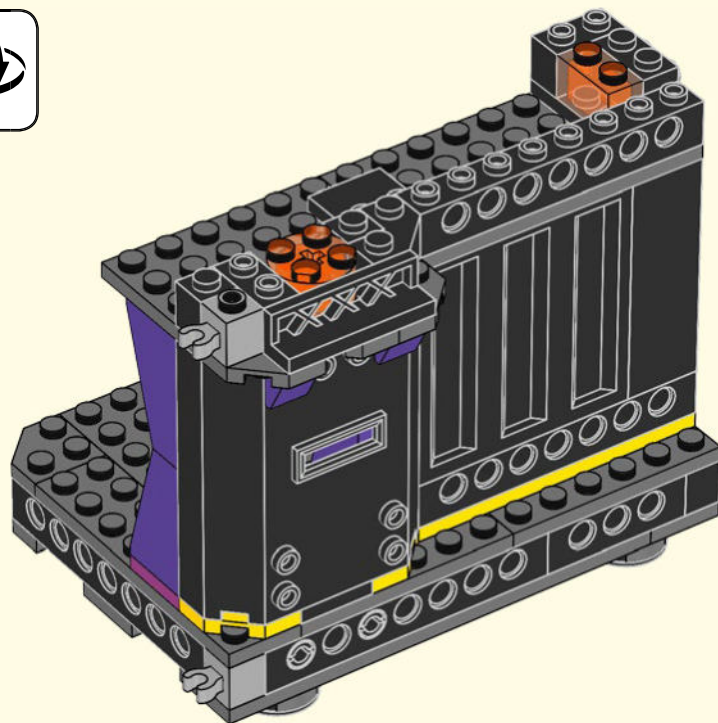

161

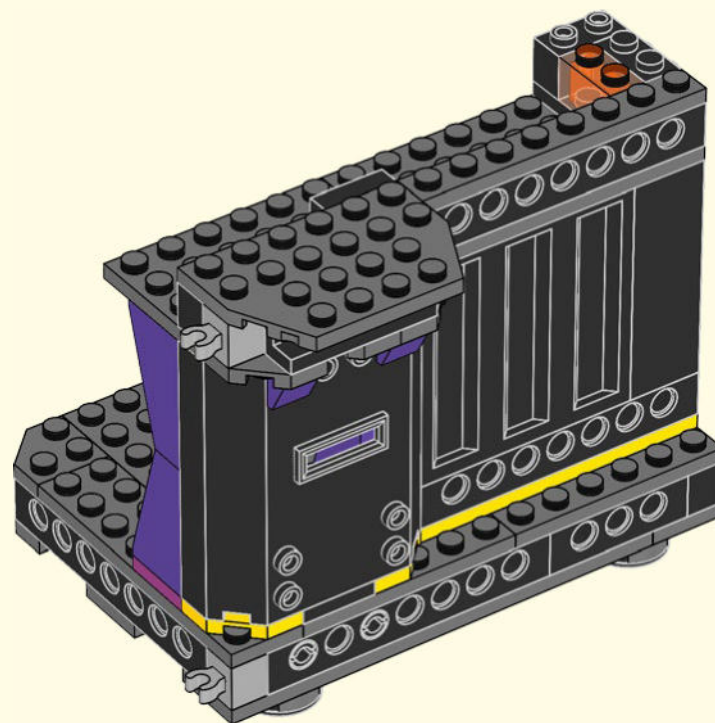



2x

162

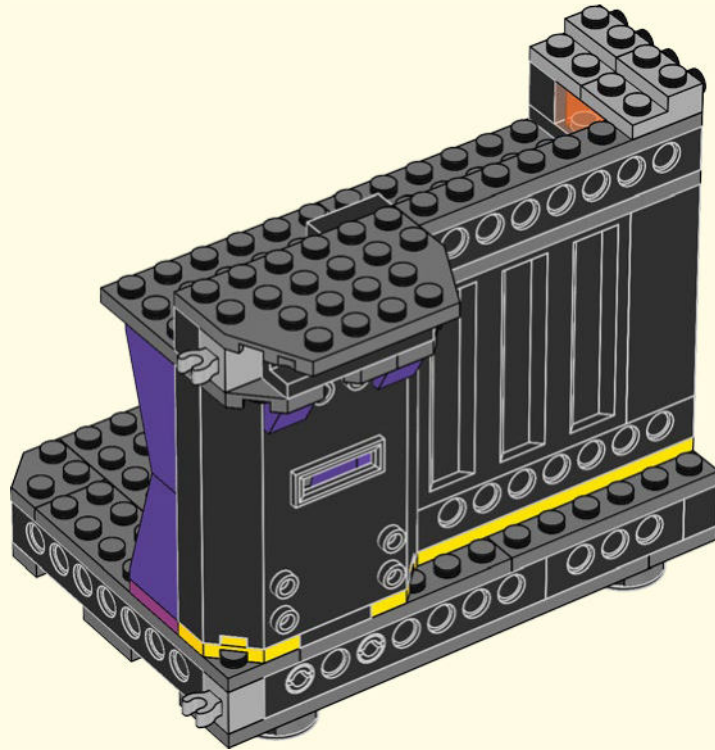



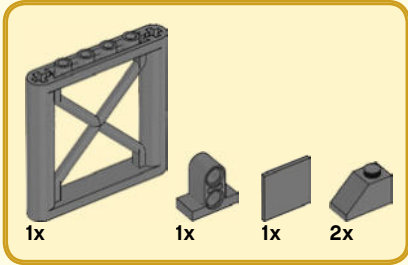
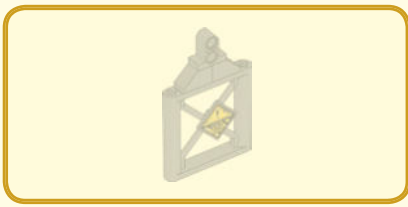

163

1

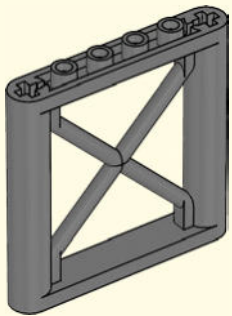

2

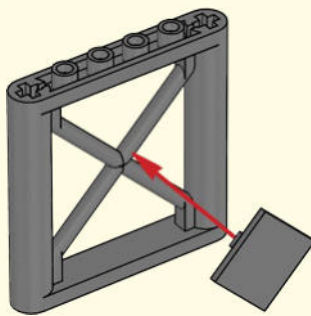

3

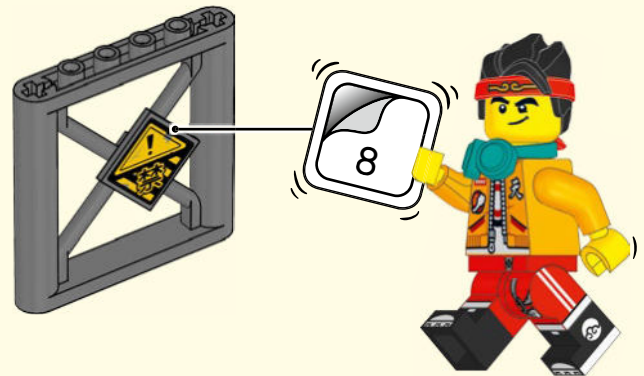

4



5

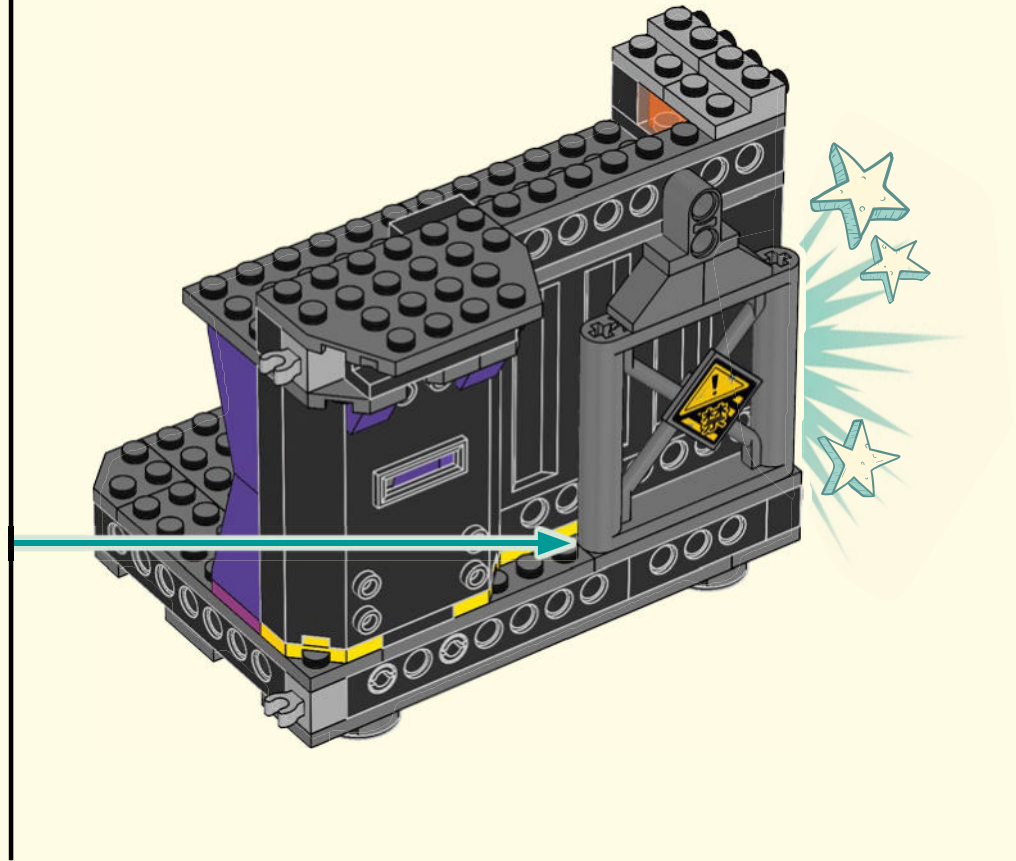



164

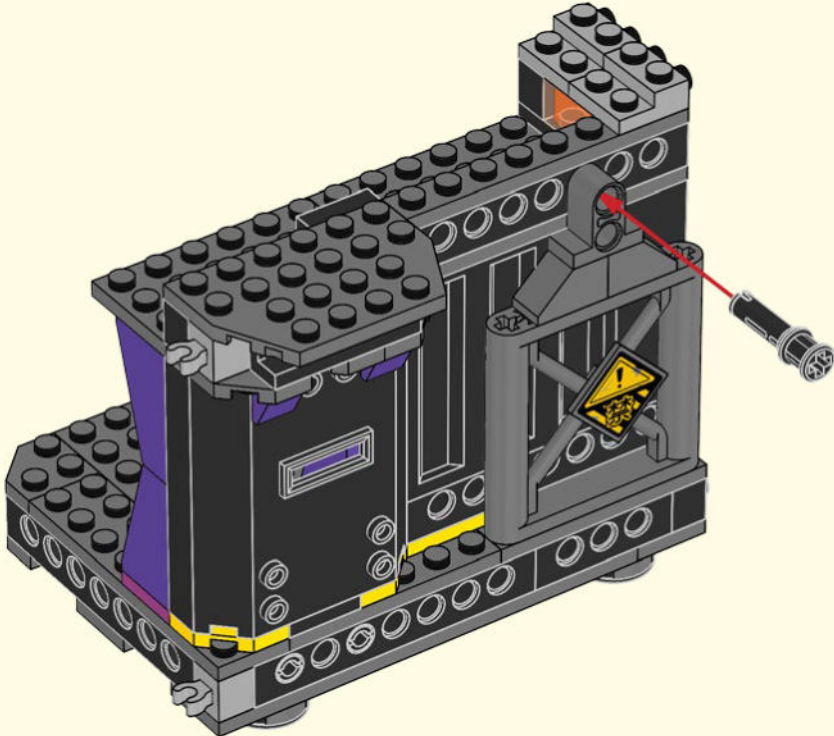

165

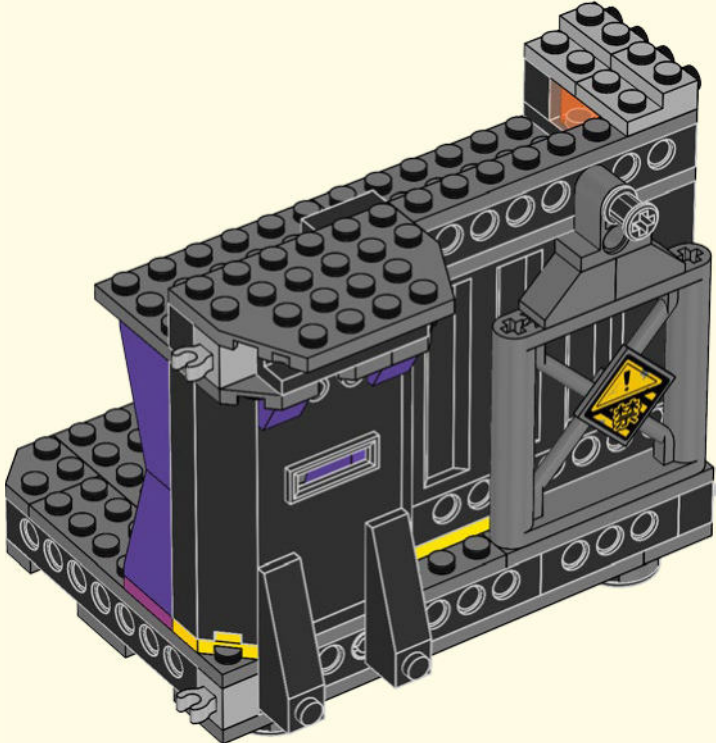

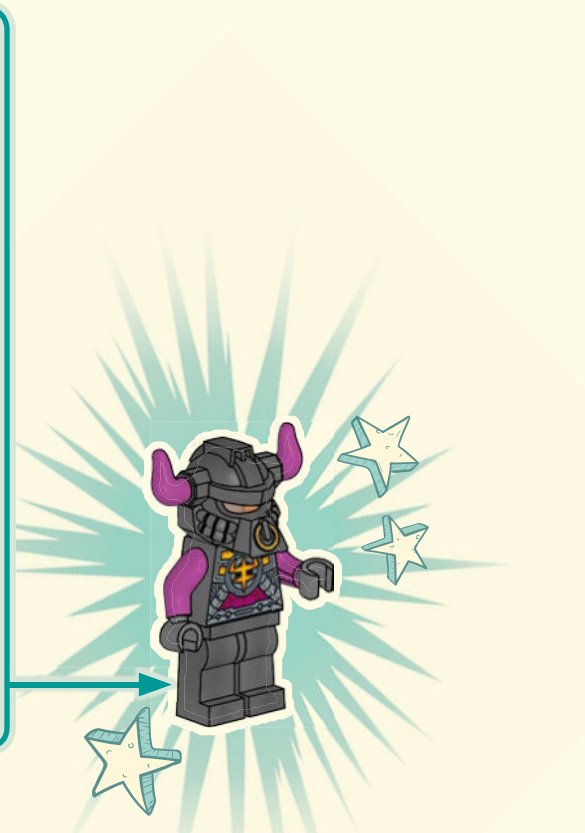
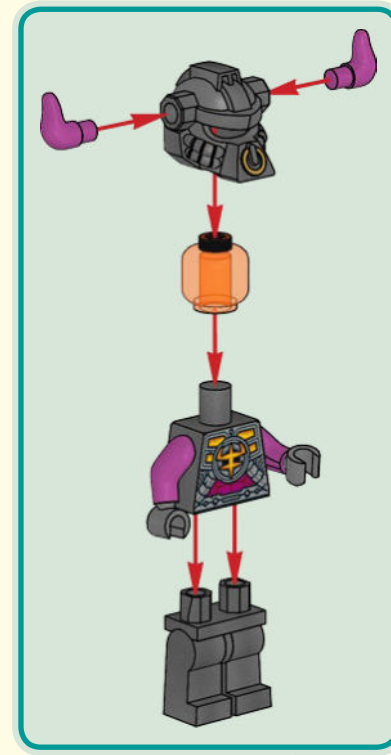

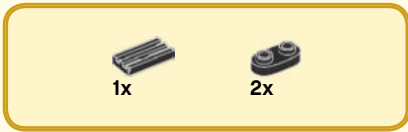

166

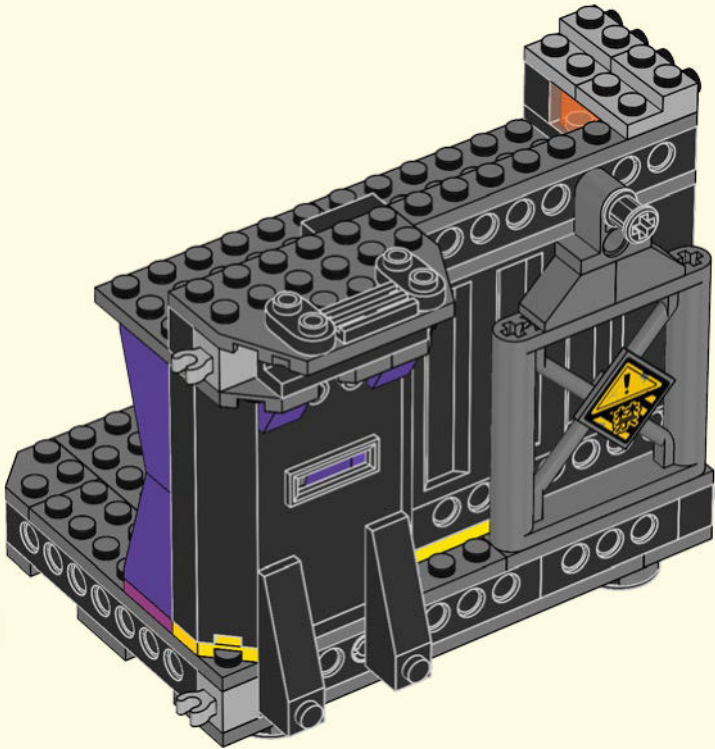

167

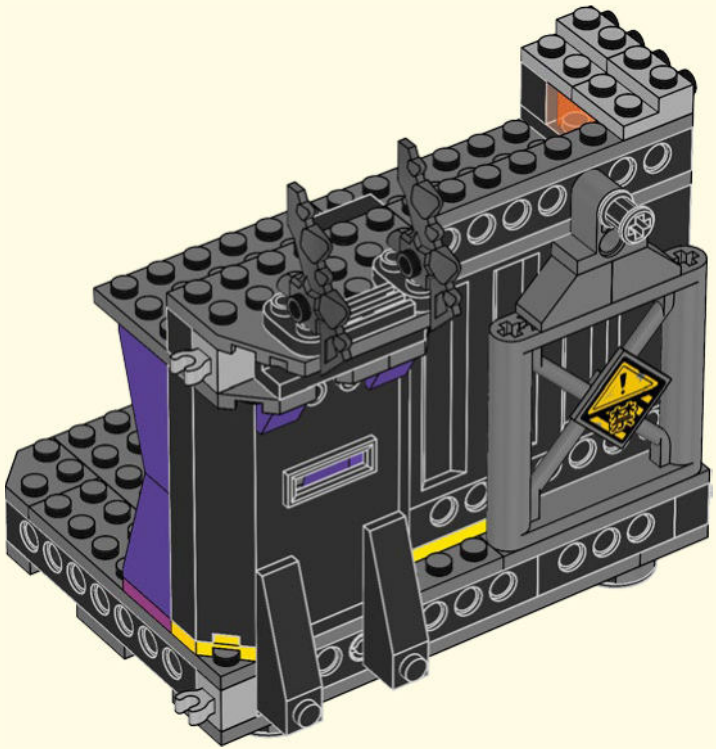



2x

168

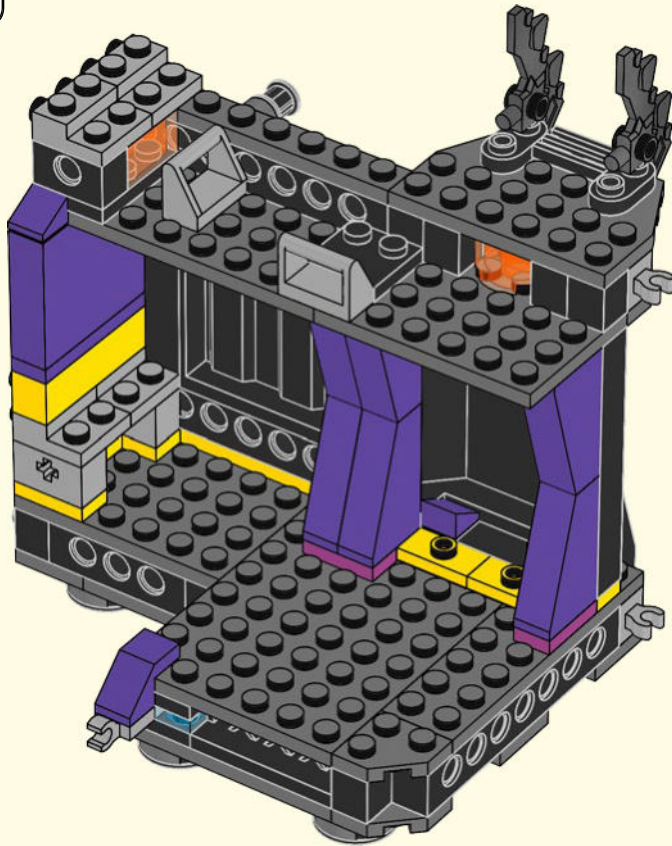

1x



1x



1x

169

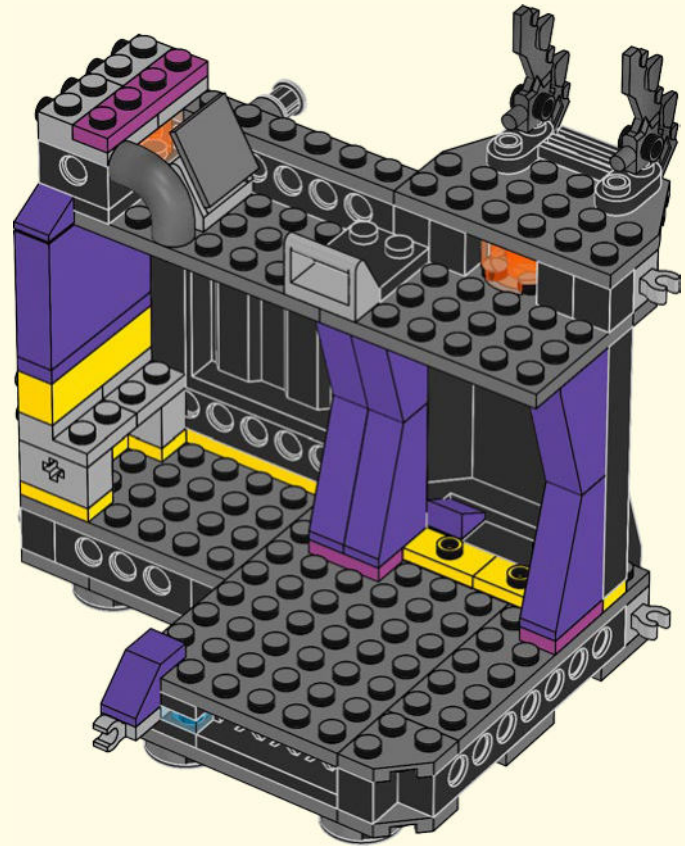



2x

170

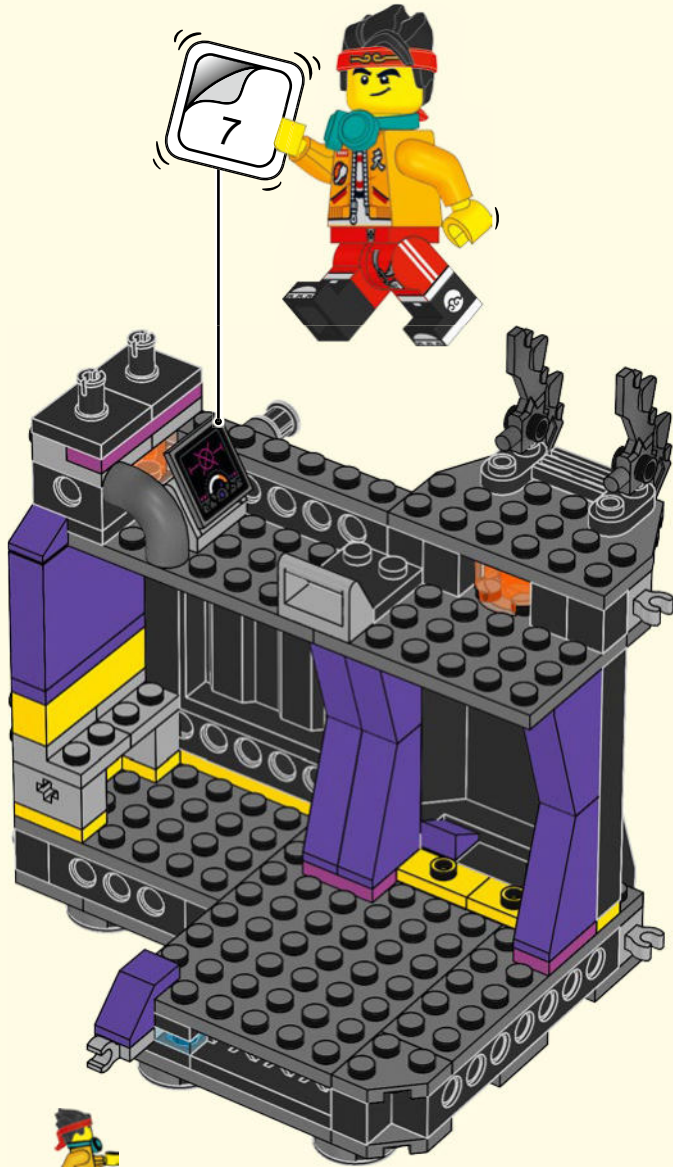

1x



1x

171

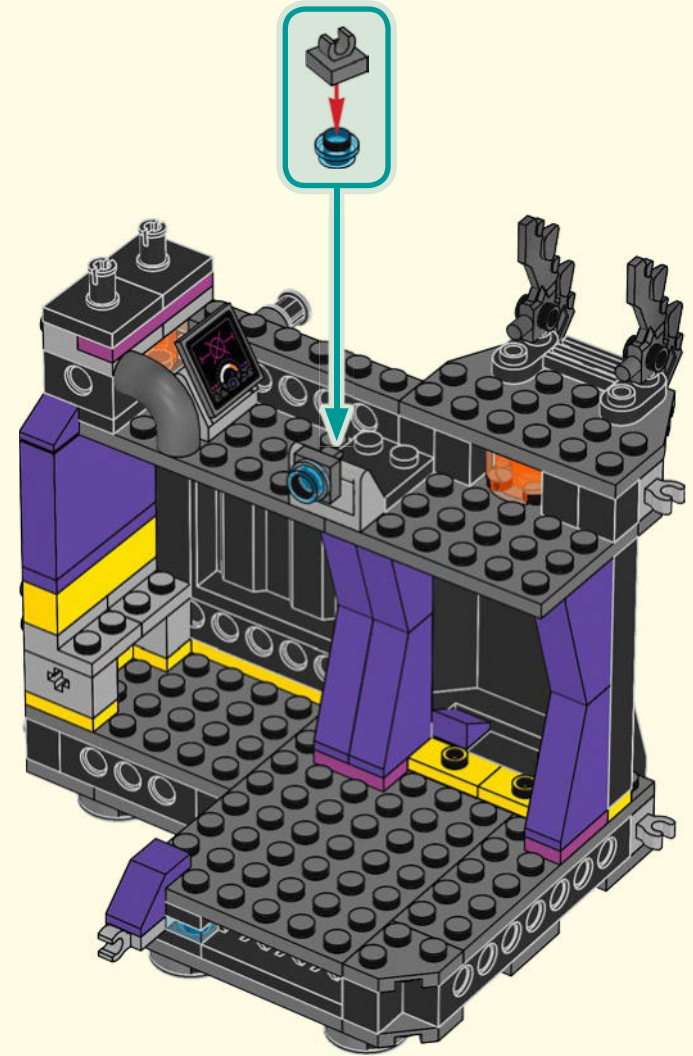

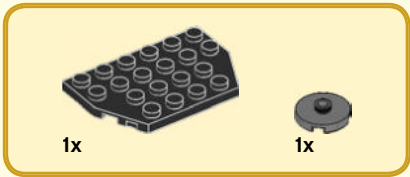

172

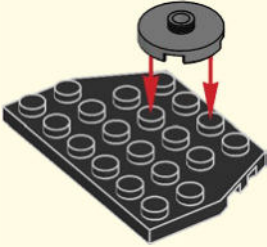

173

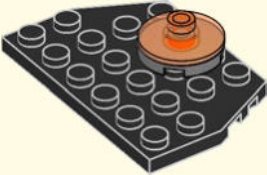

174

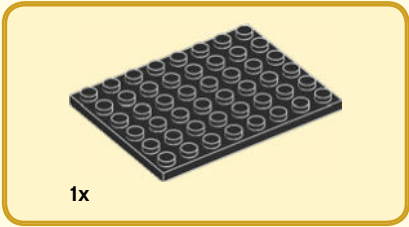
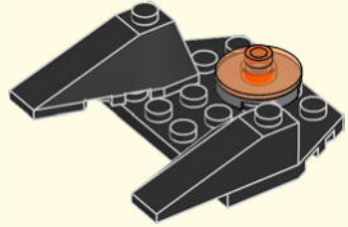

175

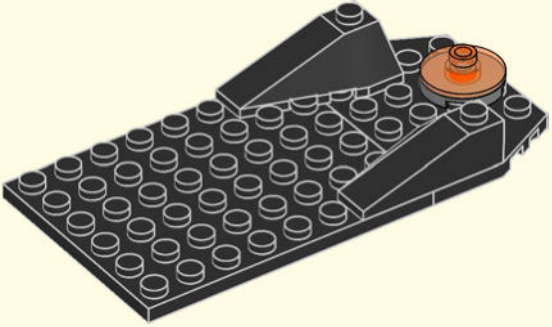





176

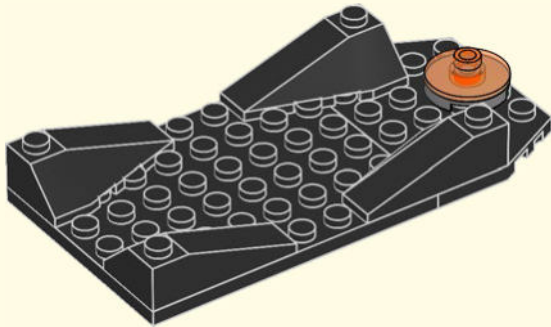

177

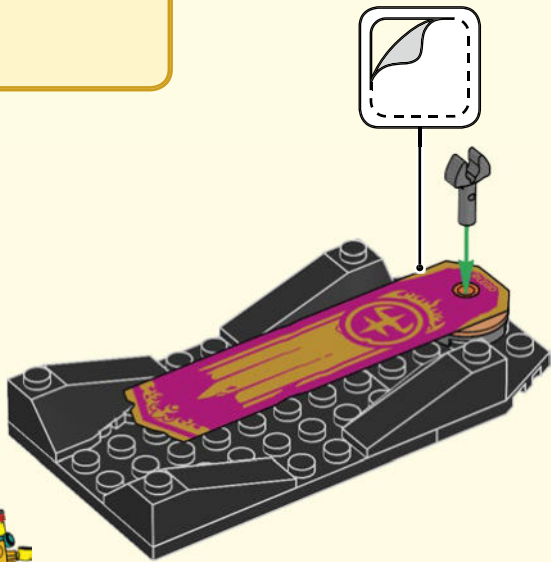

178

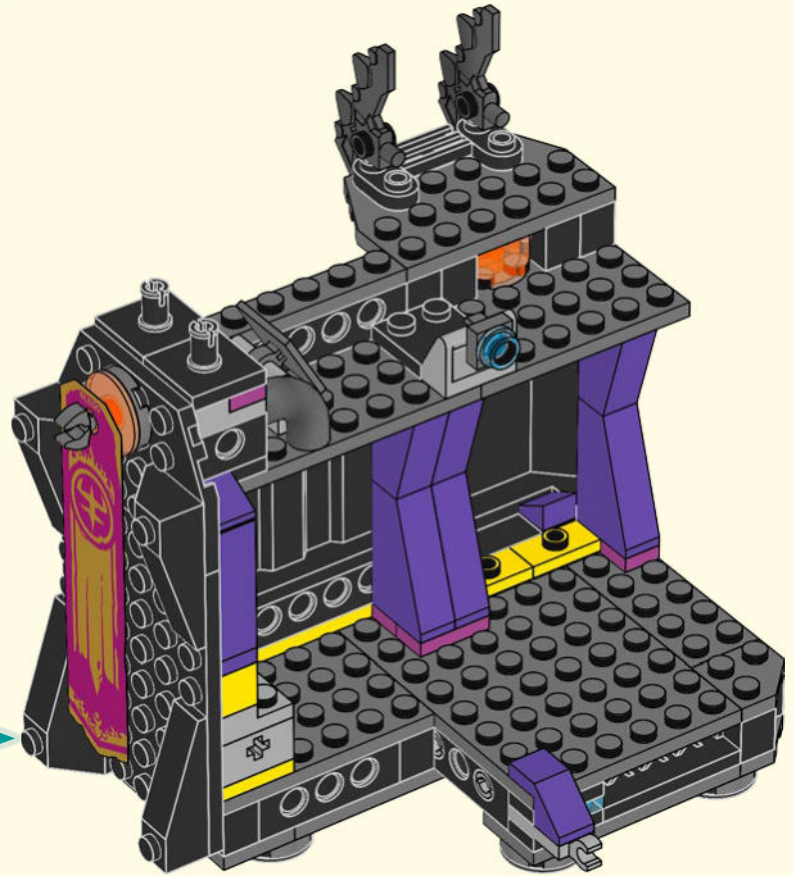



1x



2x

179

1



2

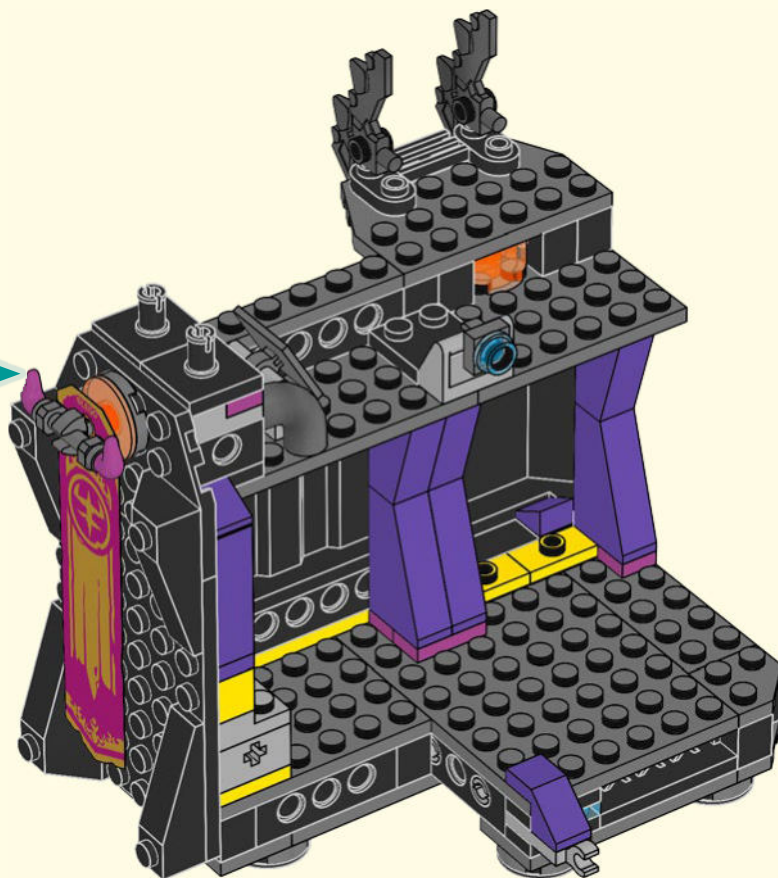



180

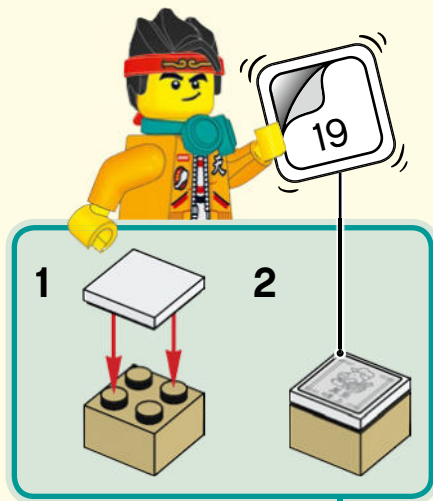

1



2

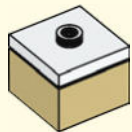

3

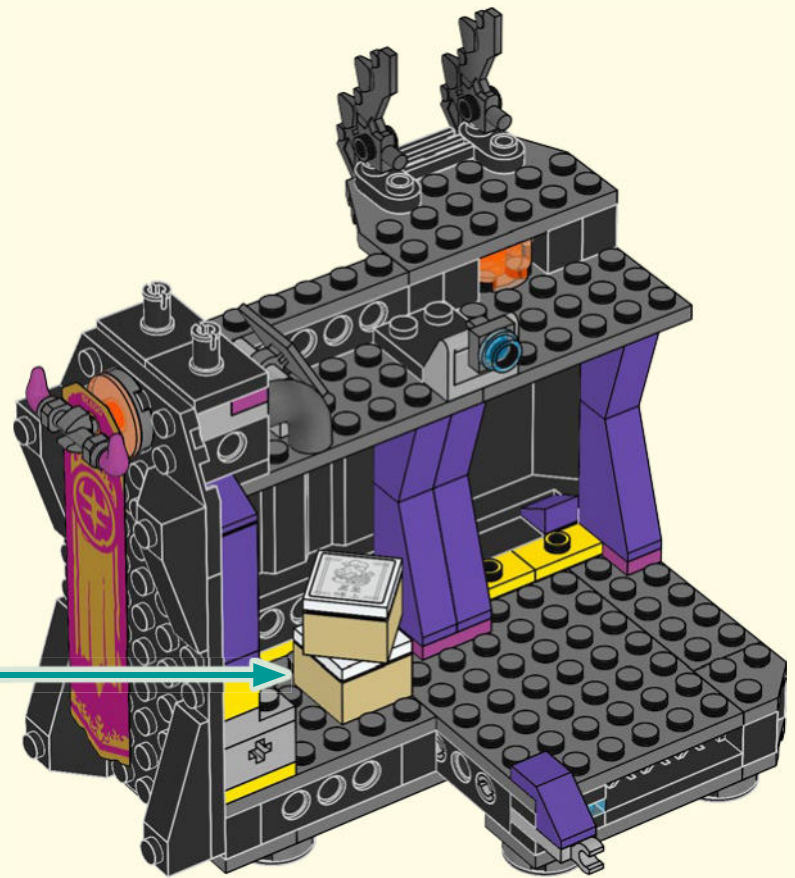

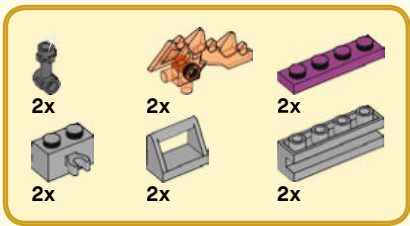

# 181

1

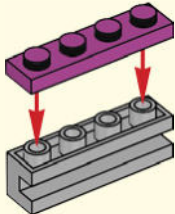

2

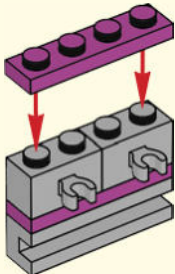

3

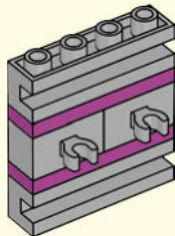

4

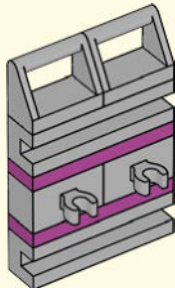

5

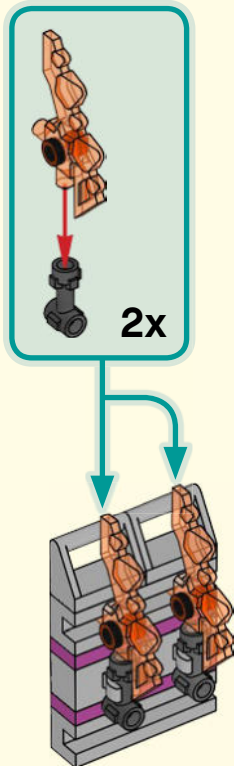

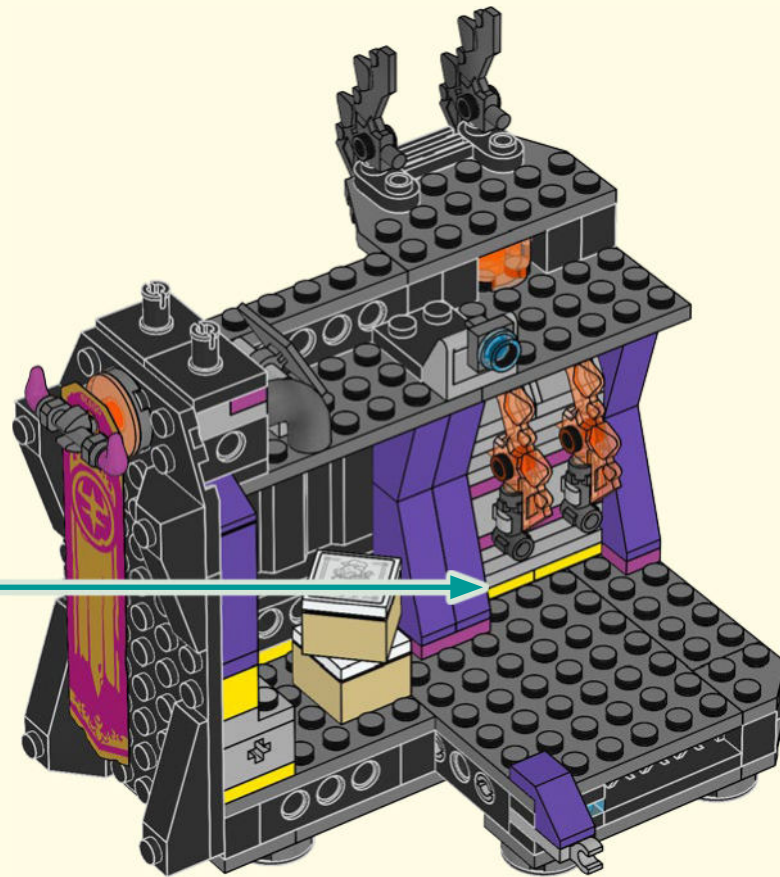



1x

182

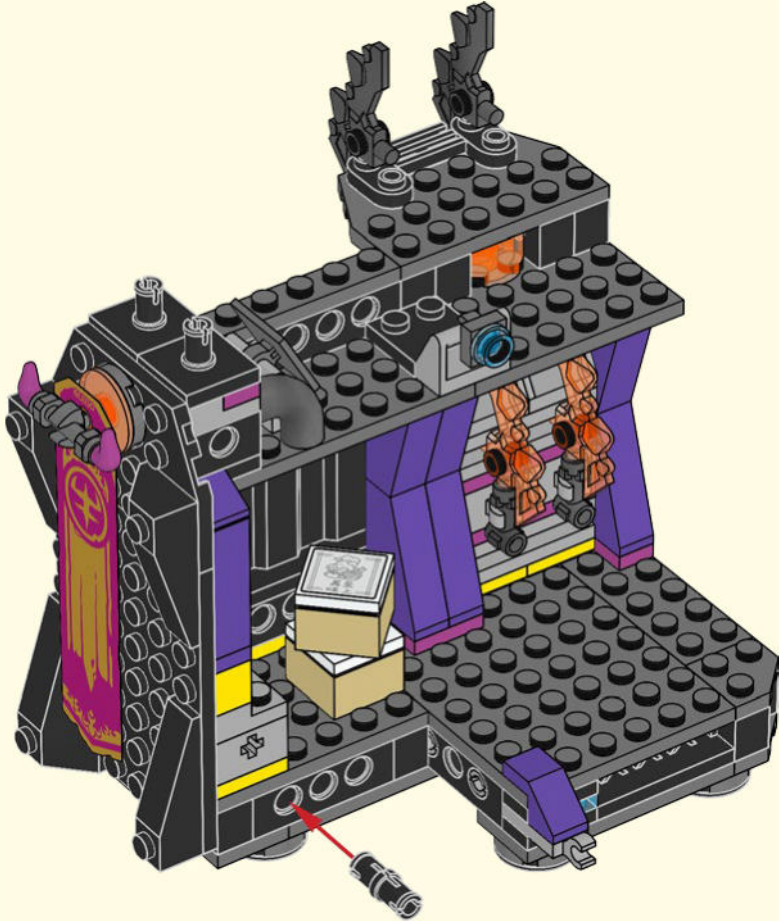

1x

183

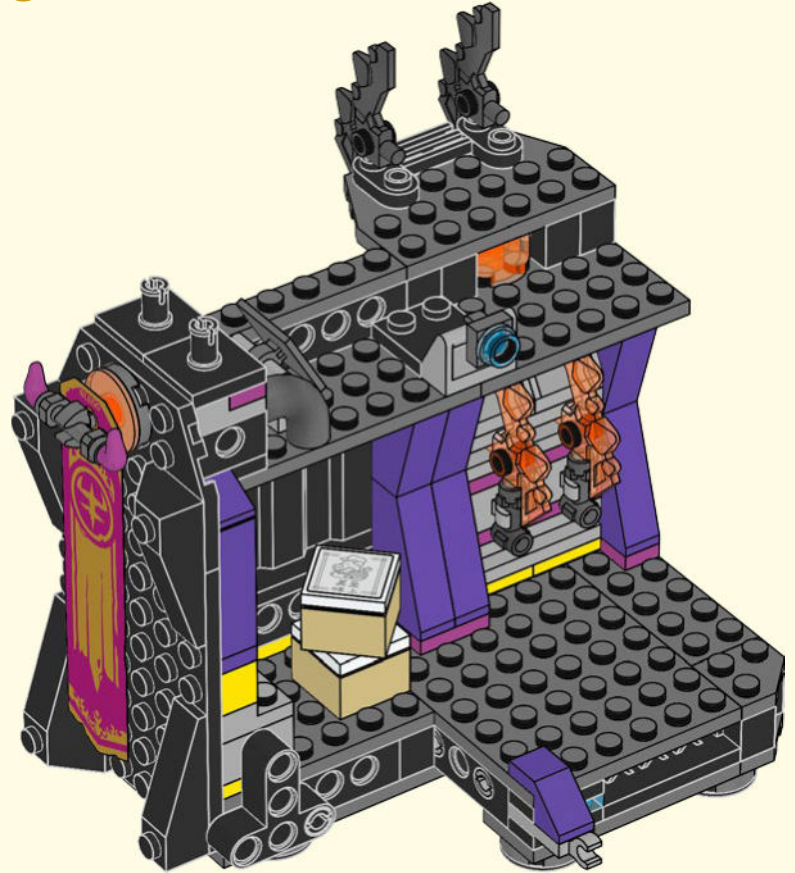

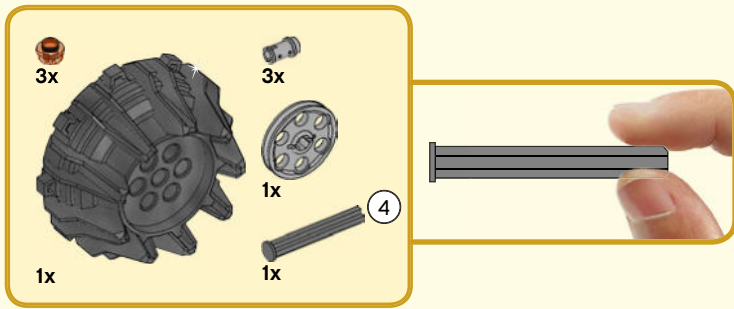

184

1

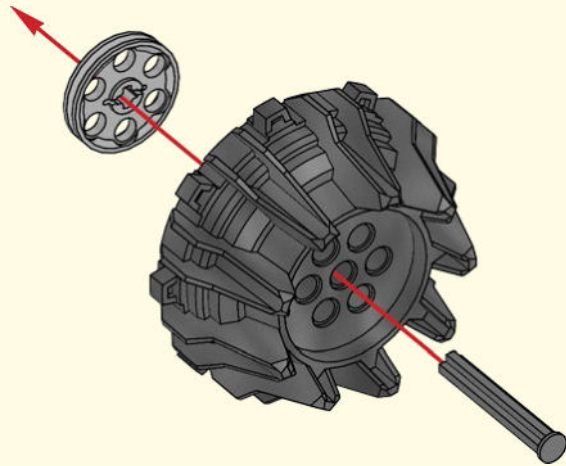

2

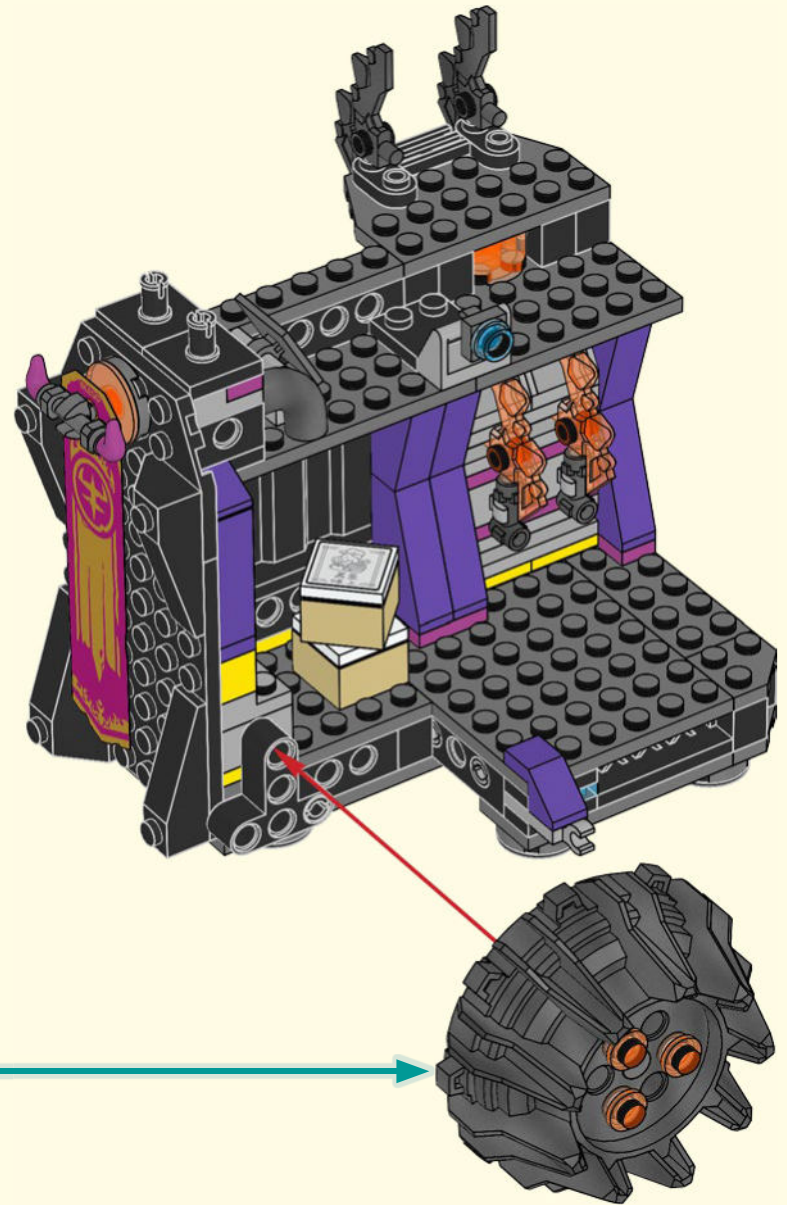
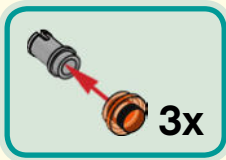
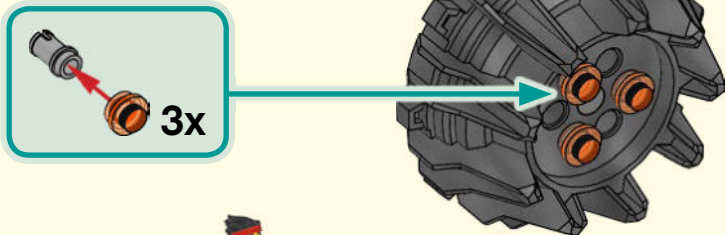



1x

185

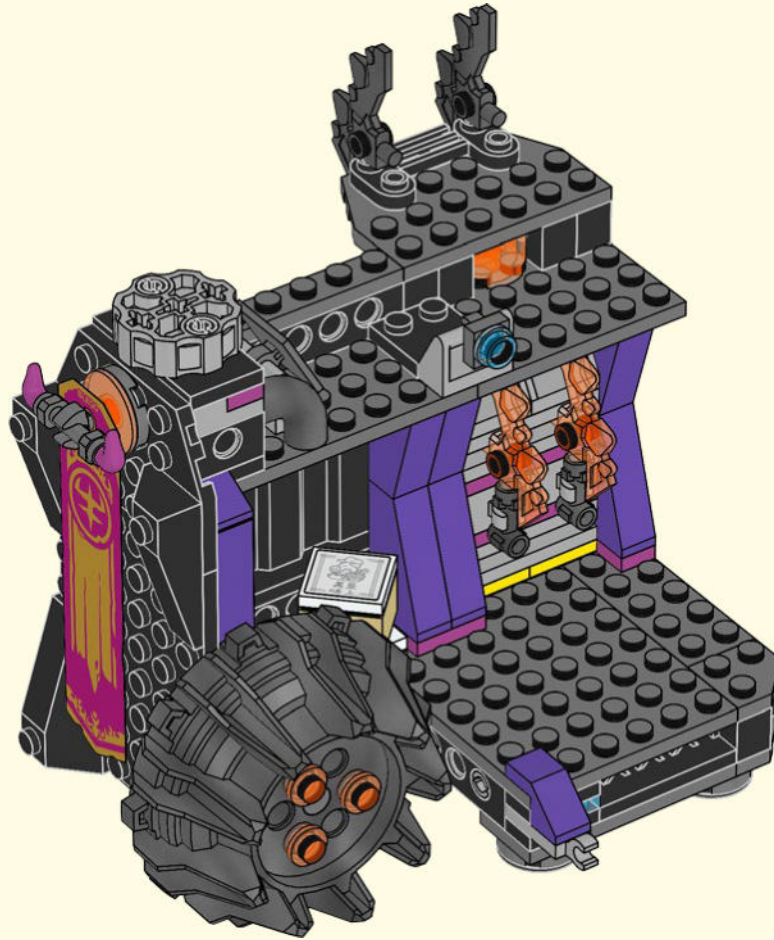





2x

186

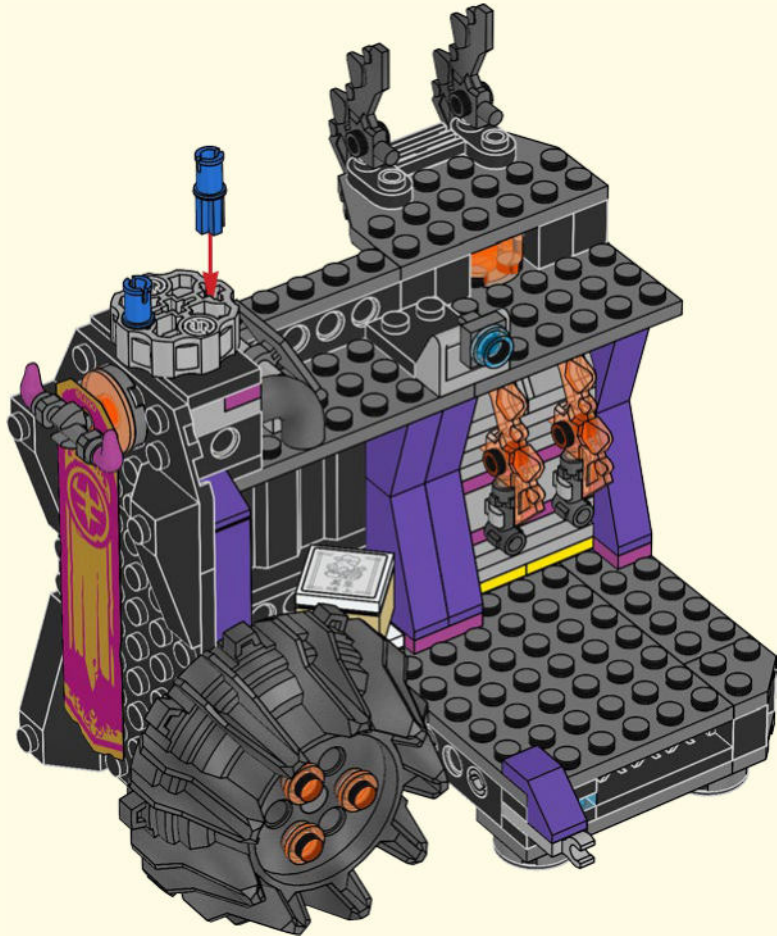

1x



1x

187

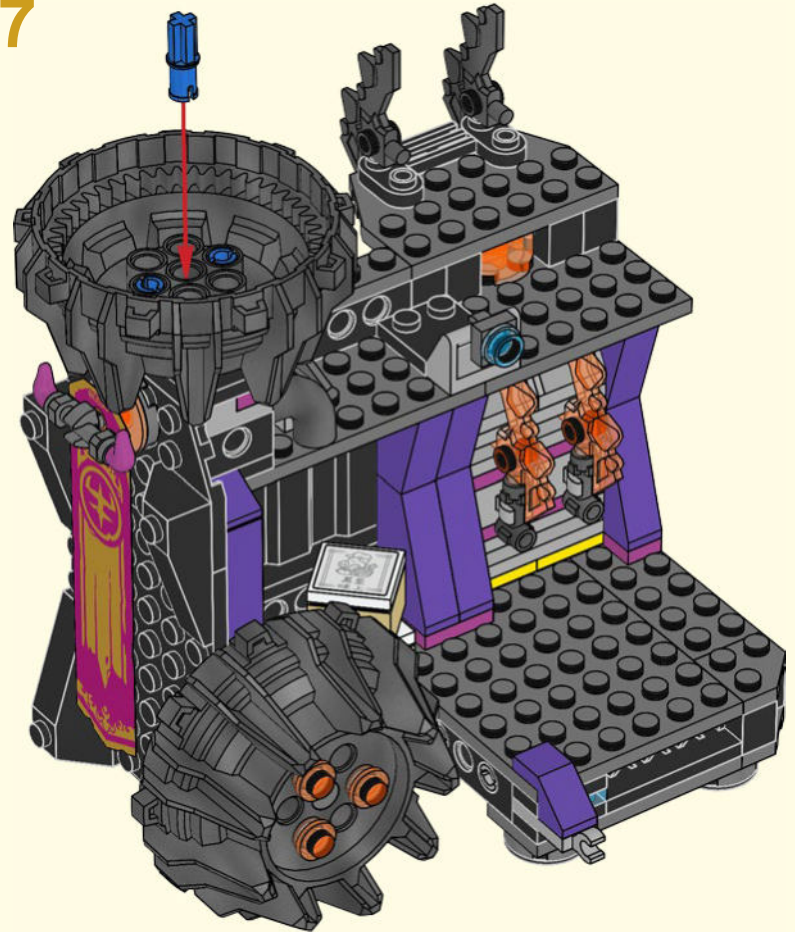



188

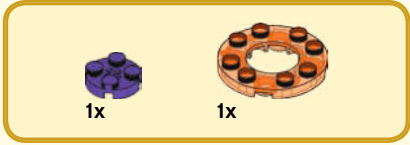

189



190



191





192

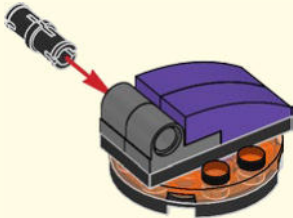

193



194

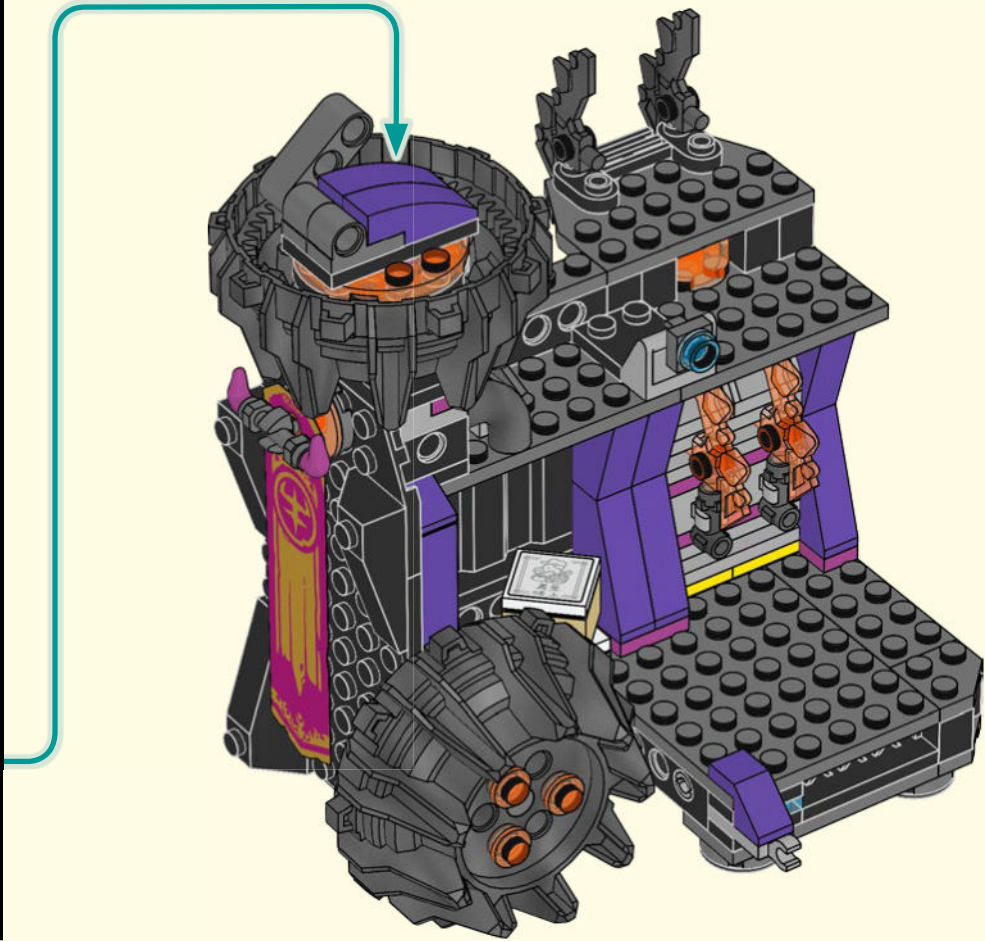

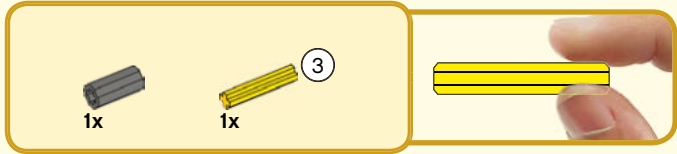

195

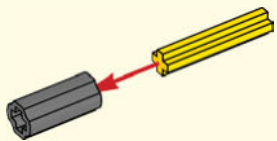

196

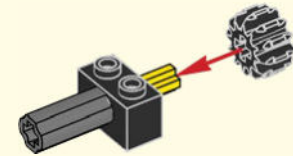

197

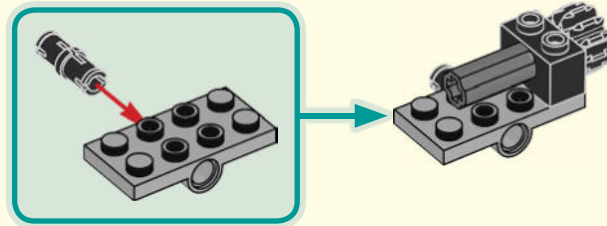

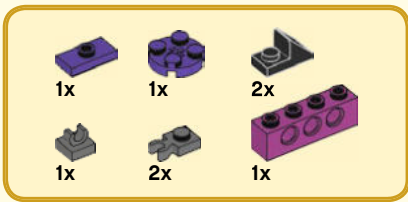

198

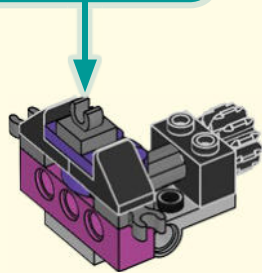
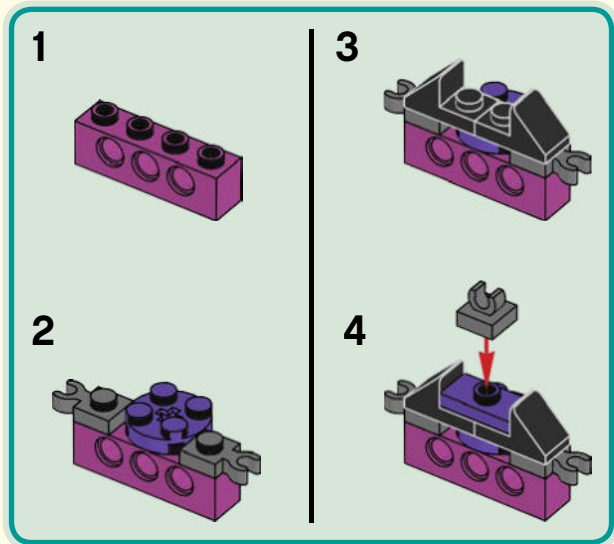

199

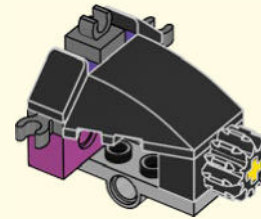

200

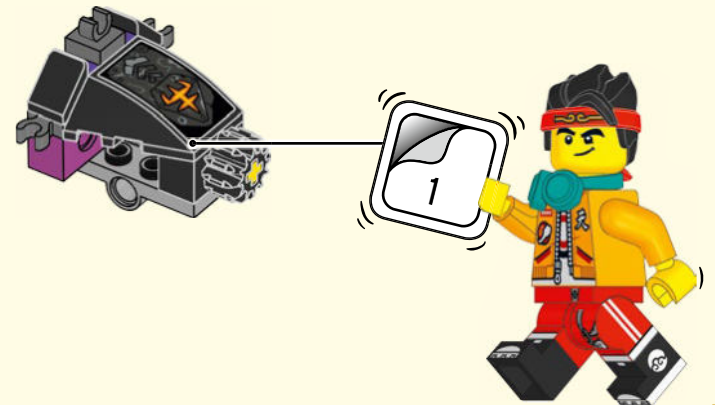



2x

# 201

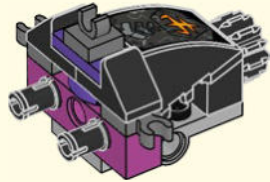

1x



1x



# 202

CLICK KLICK  
CLIC CLIQUE  
KATT KLIKŠKIS  
卡塔

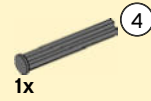
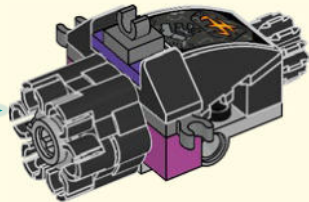
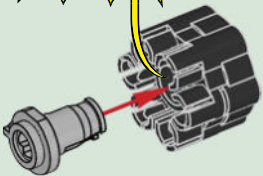

1x

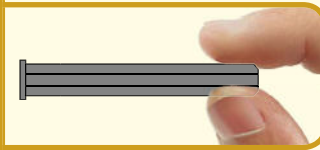

# 203

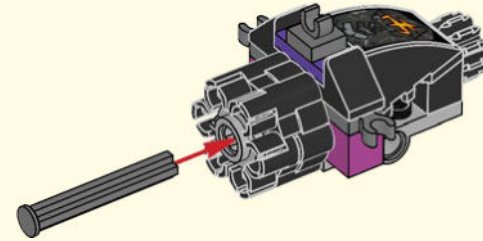

2x

# 204

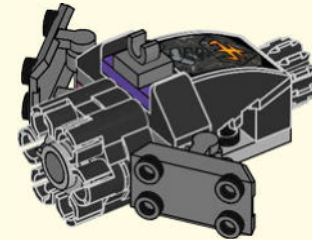

205

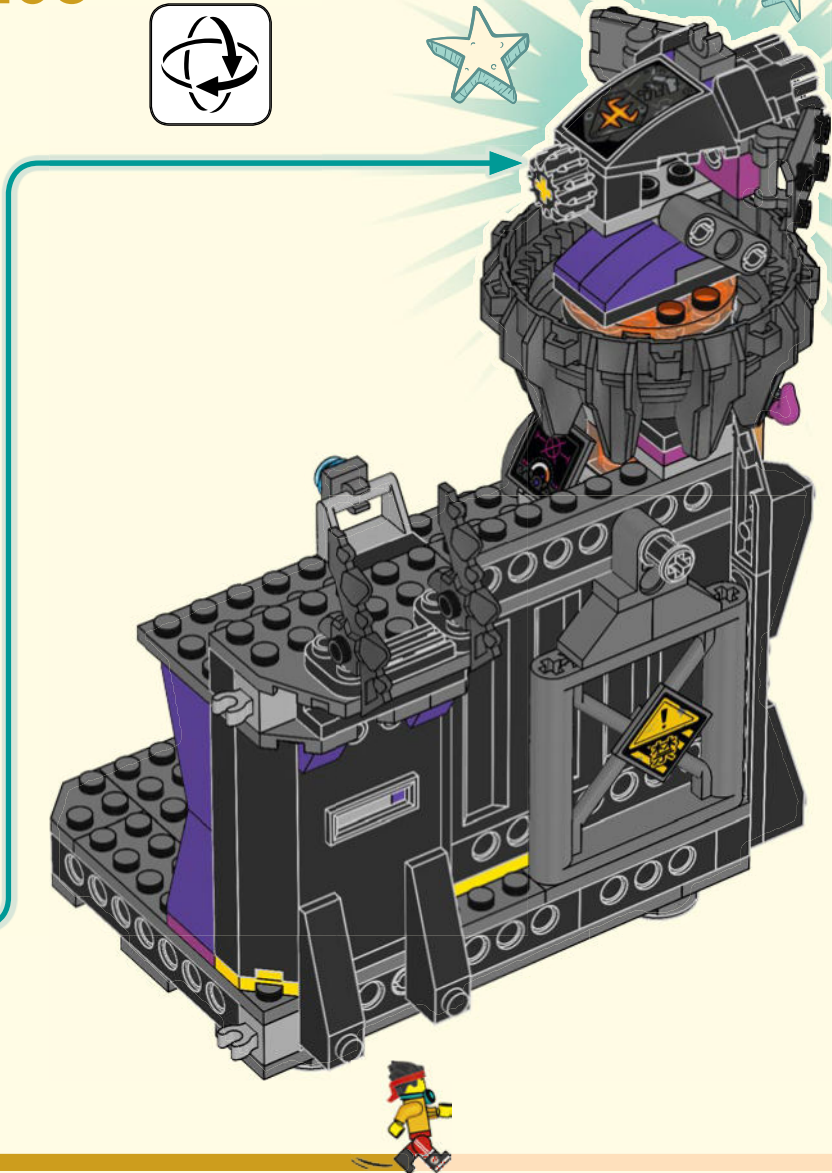

206

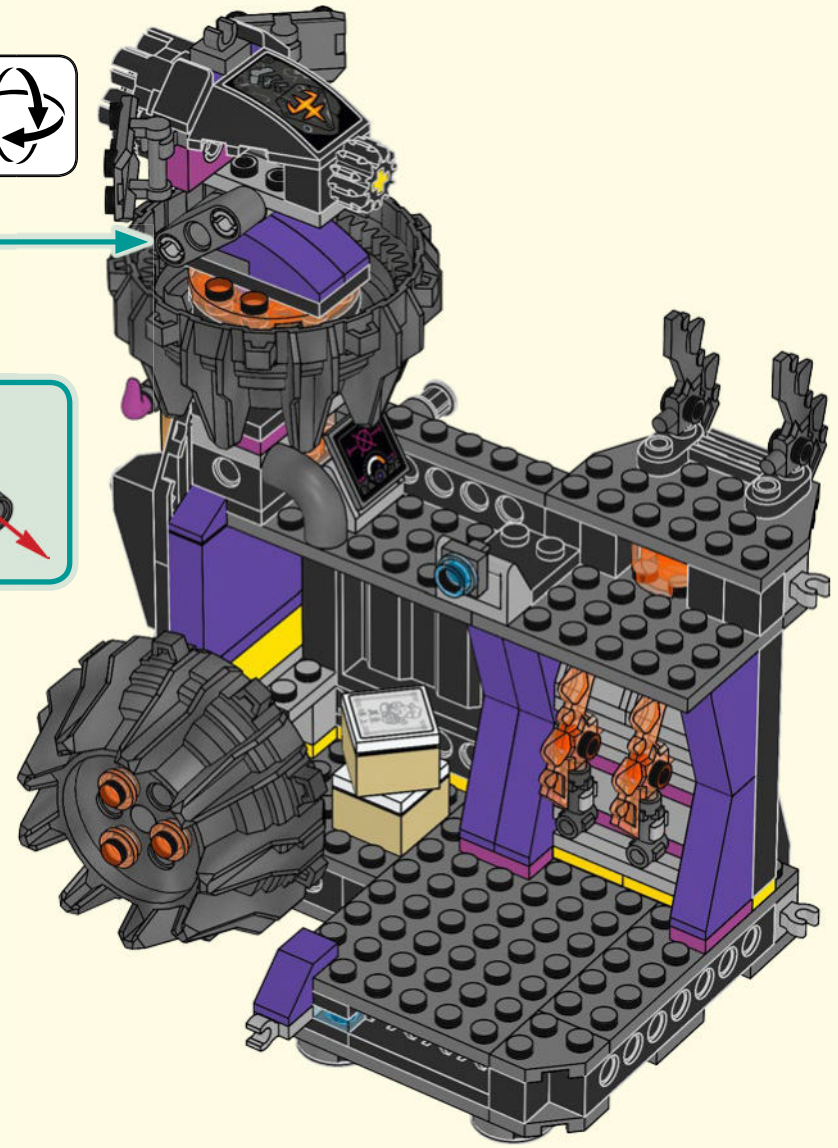
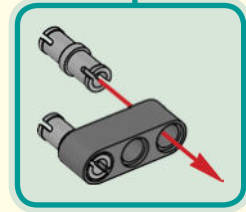
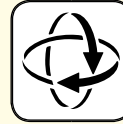
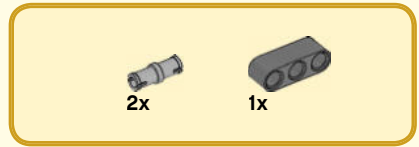



1x

207

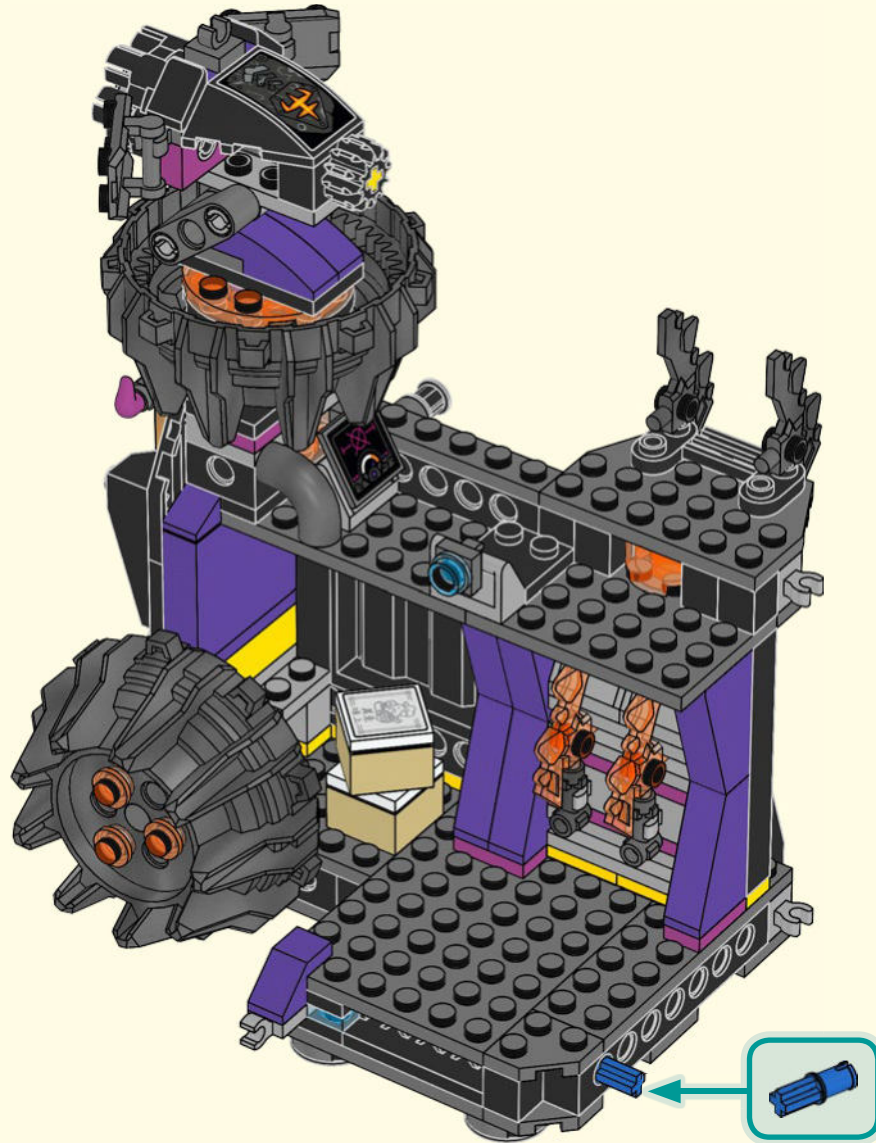



208

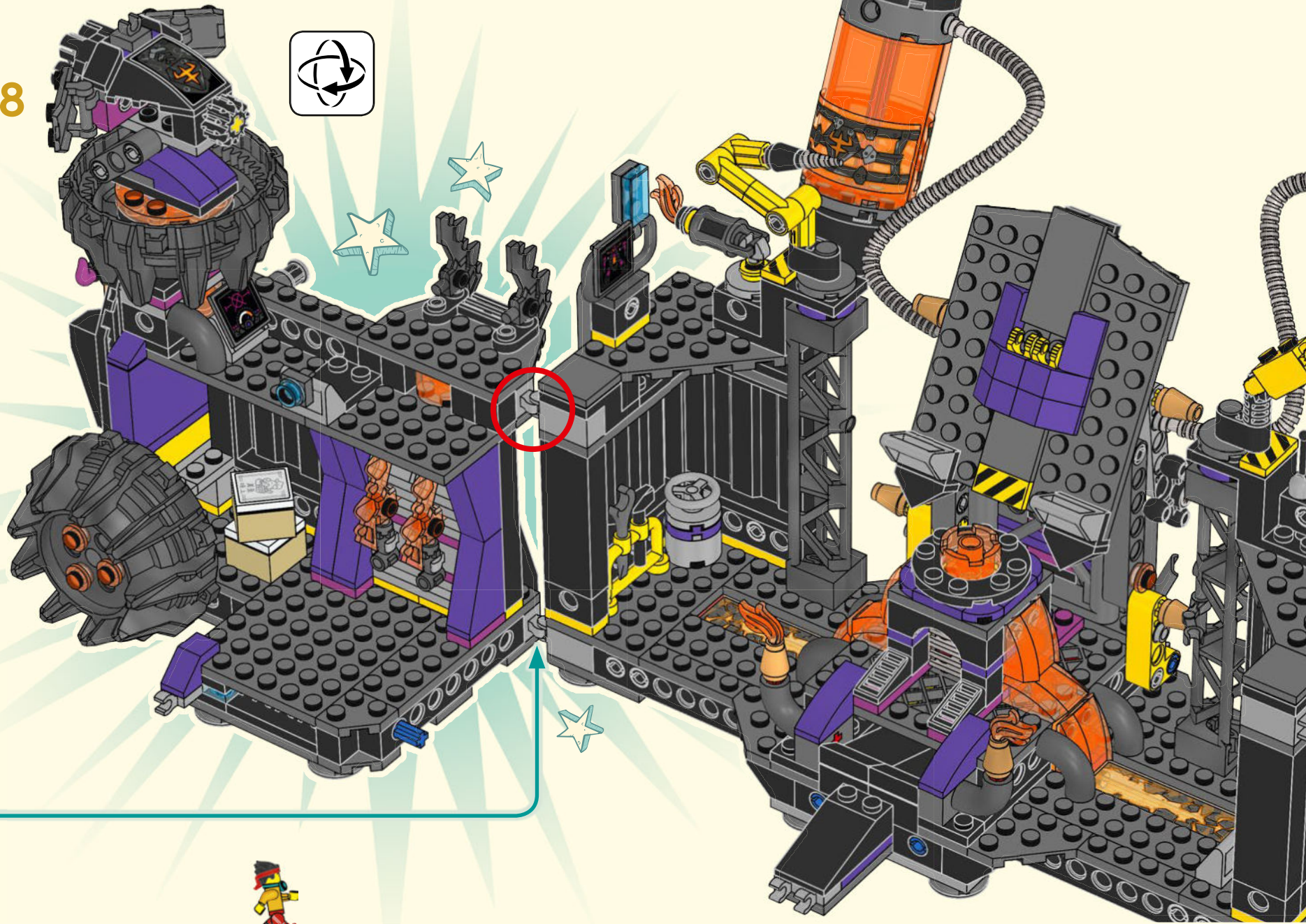

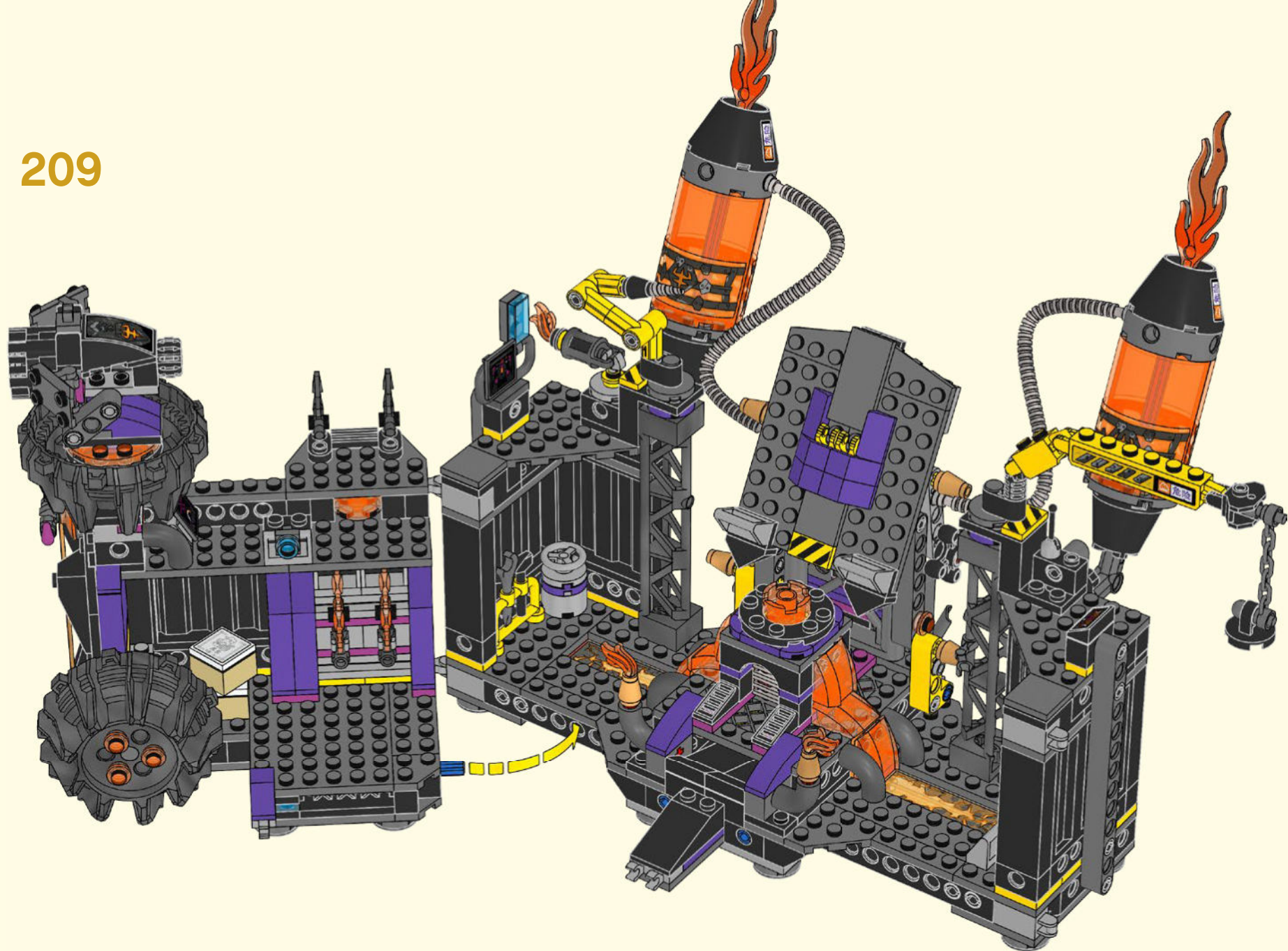

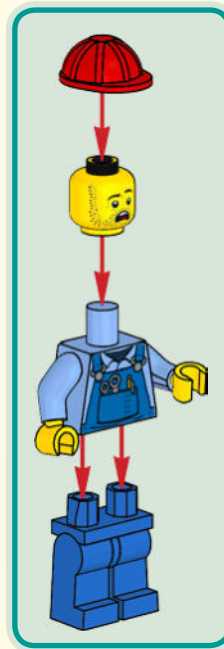

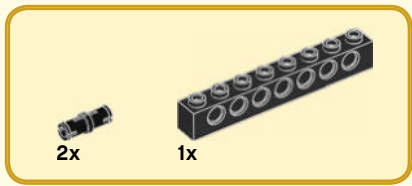

210

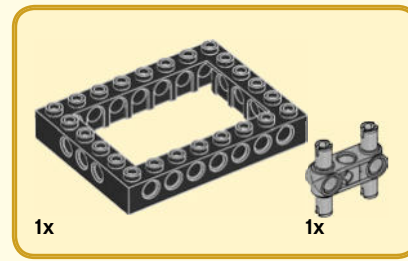
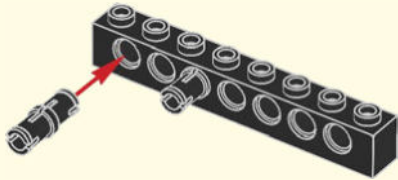

211

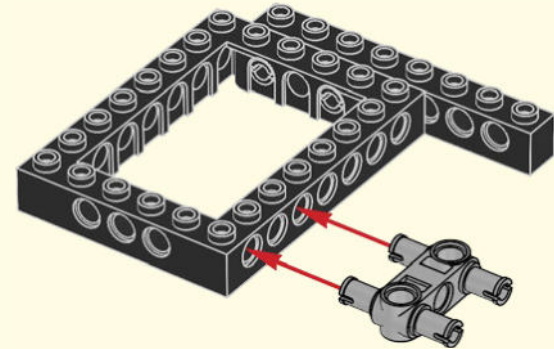

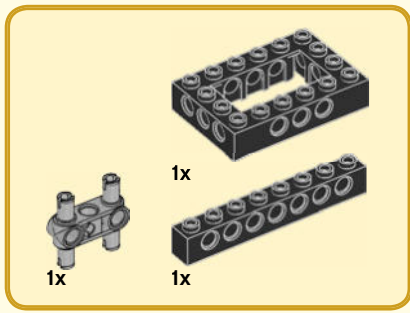

212

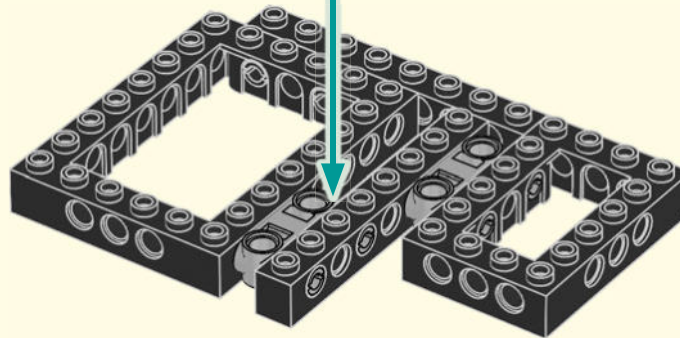
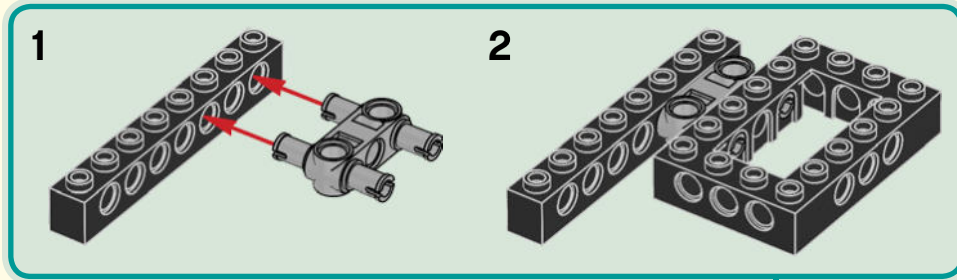

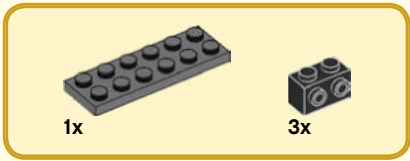

# 213

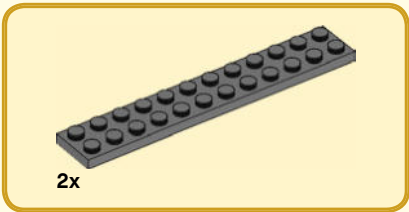
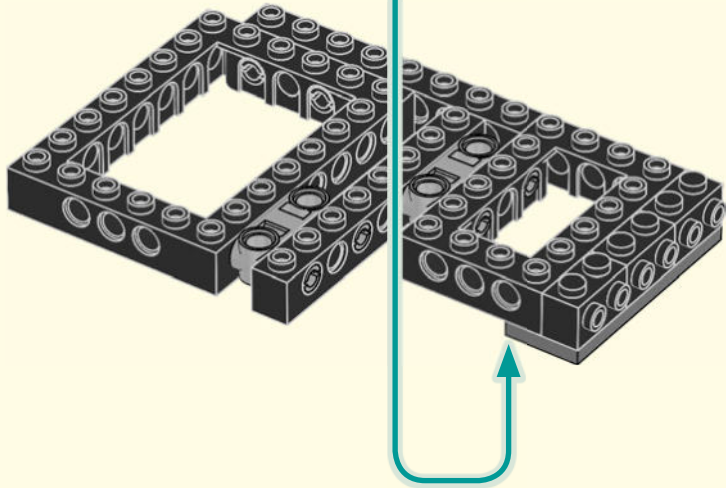
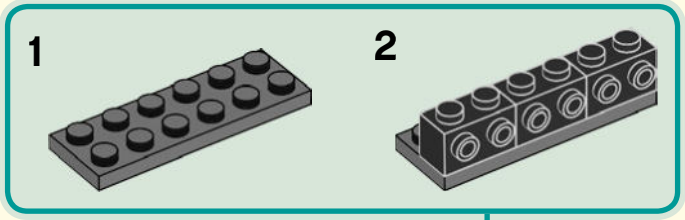

# 214

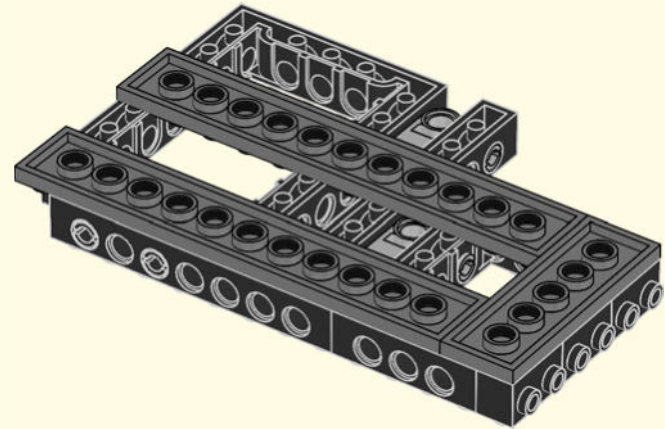

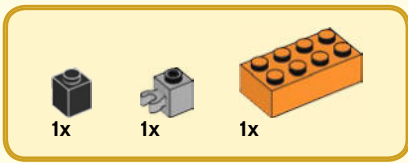

215

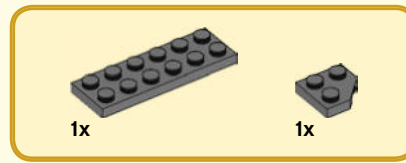
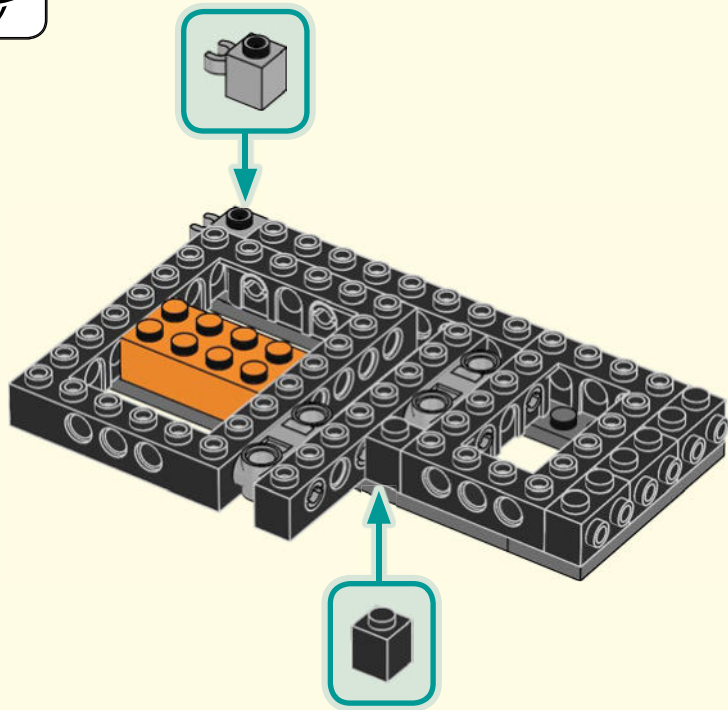

216

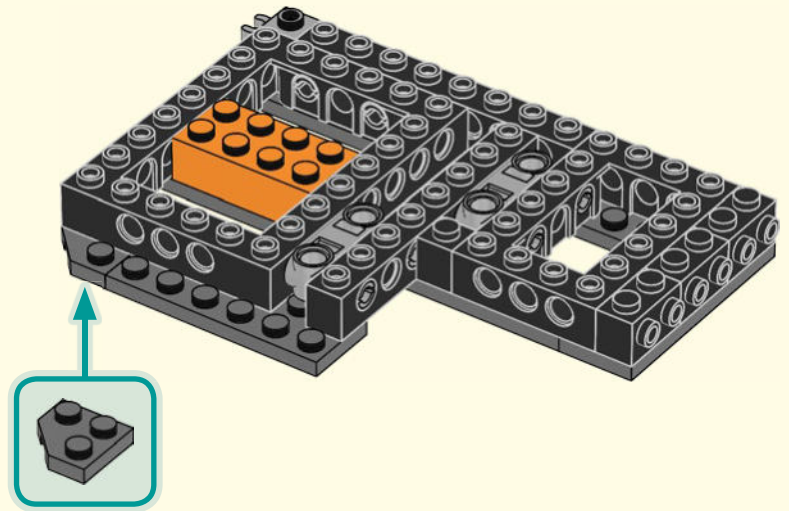



1x



1x

# 217

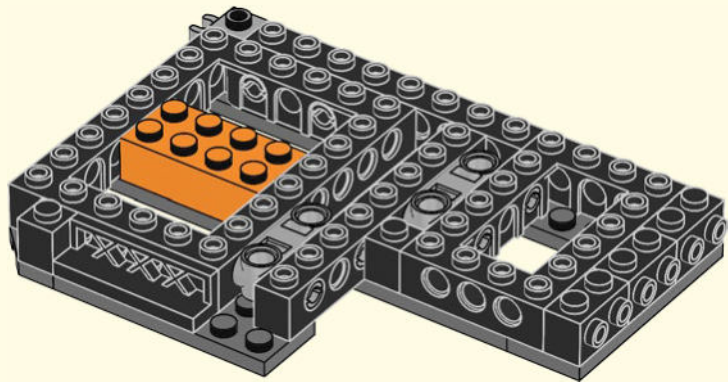

1x



2x



1x

# 218

1

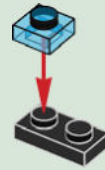

2



3

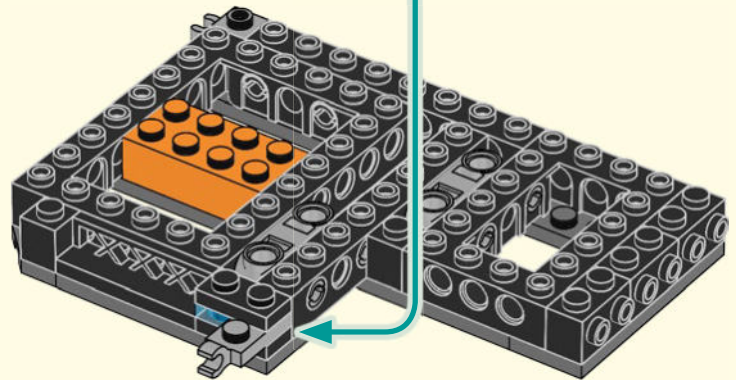



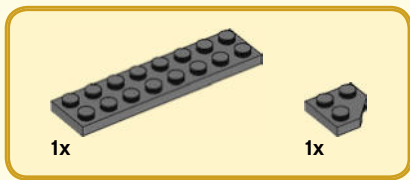

219

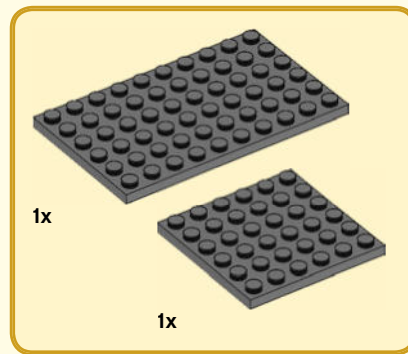
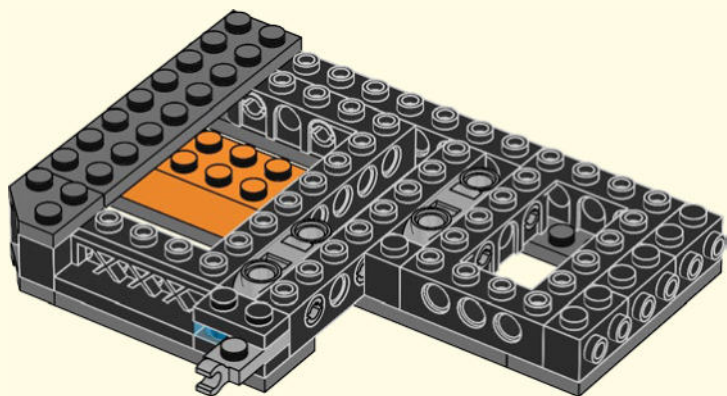

220

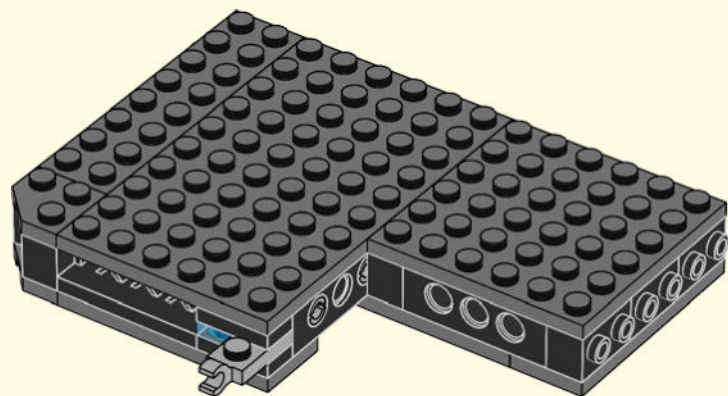



221

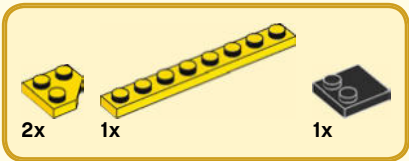
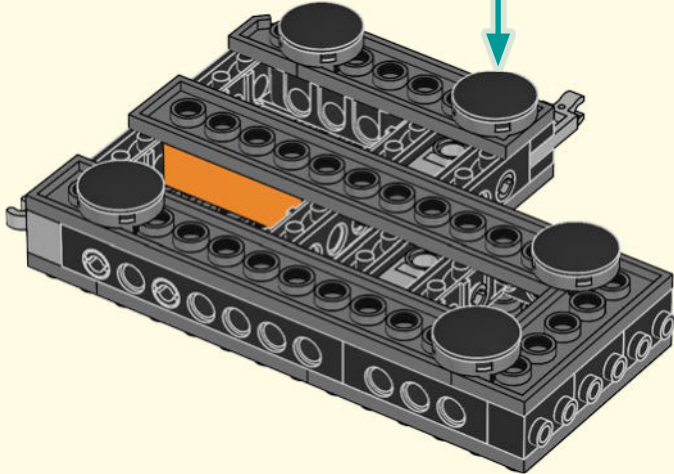
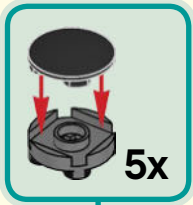
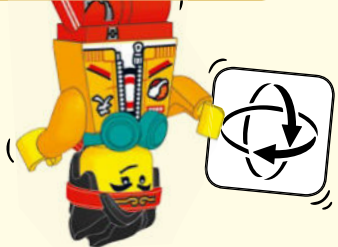

222

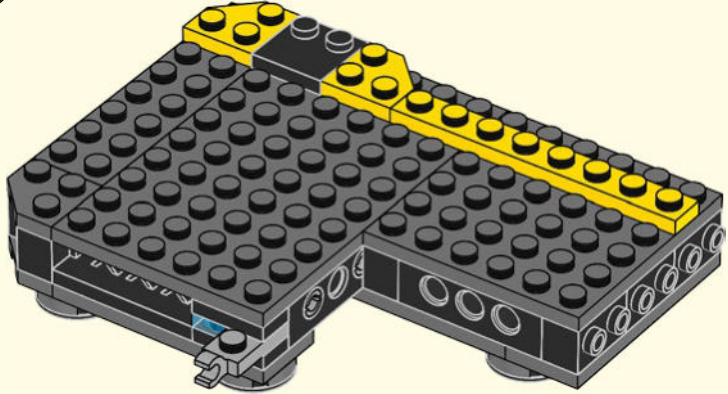

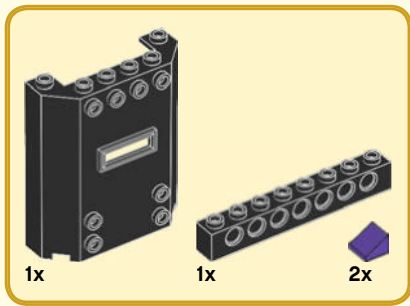

223

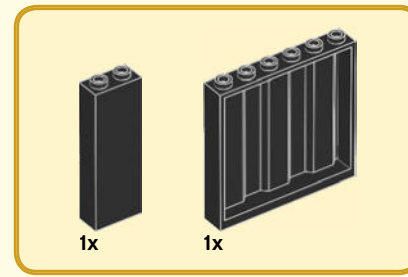
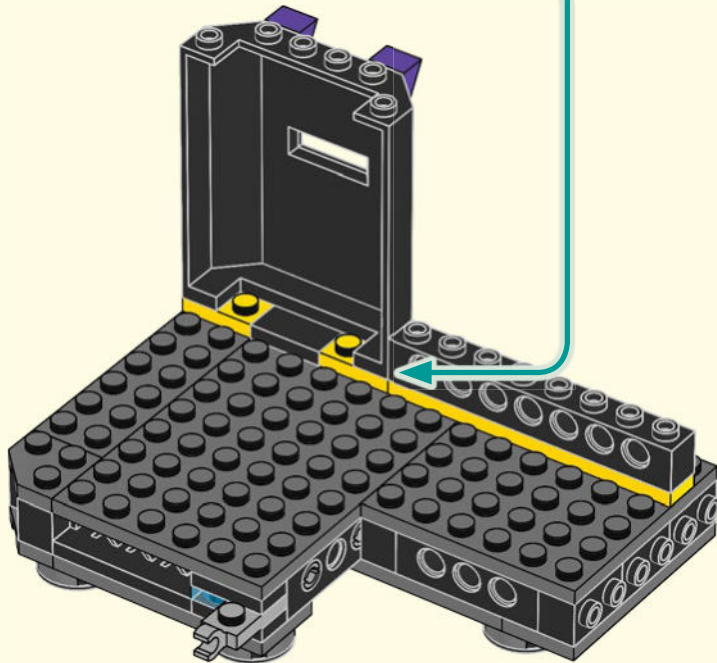
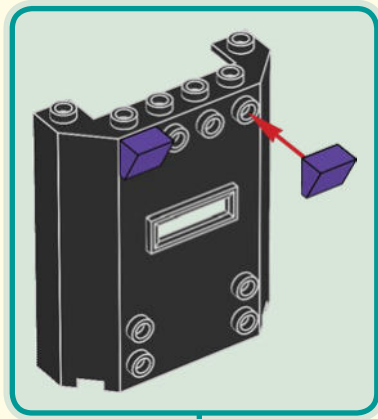

224

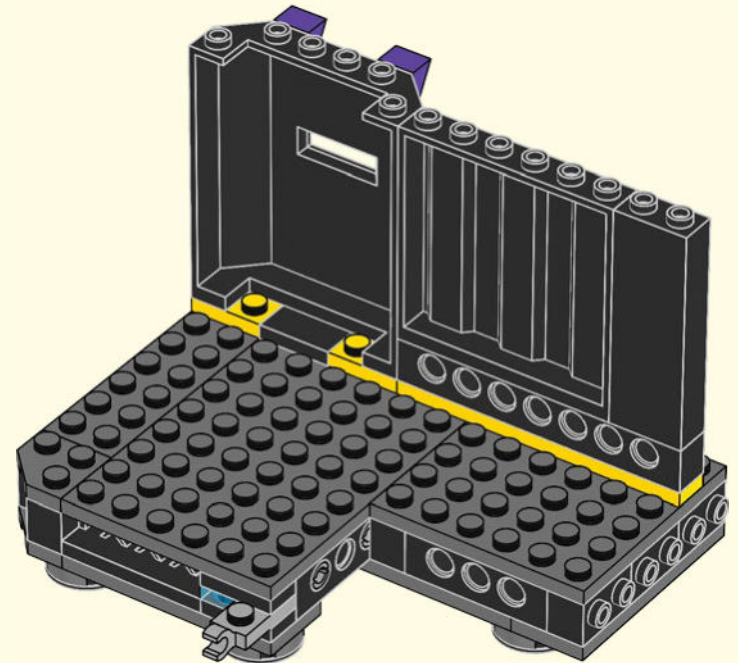



2x



3x

# 225

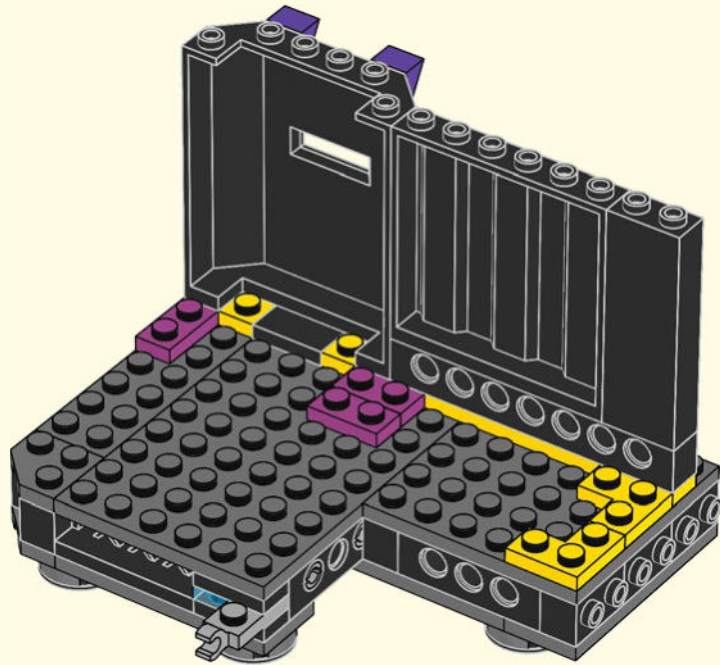

3x



2x

# 226

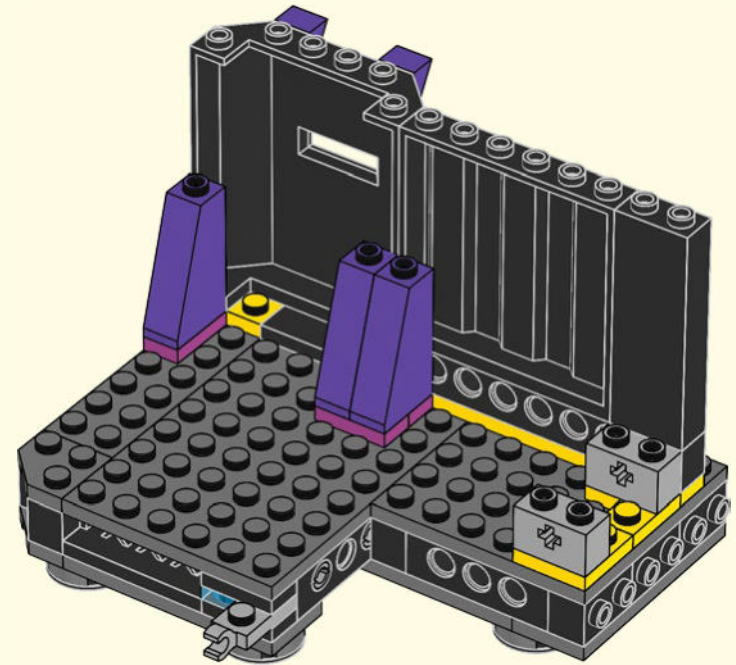



227

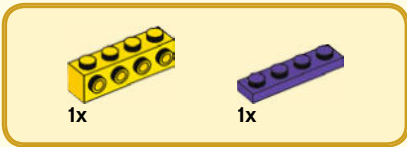
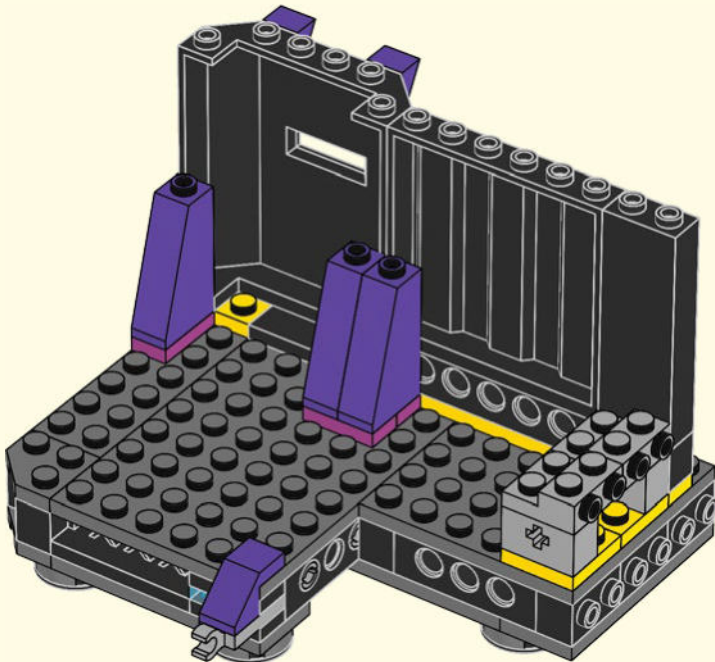

228

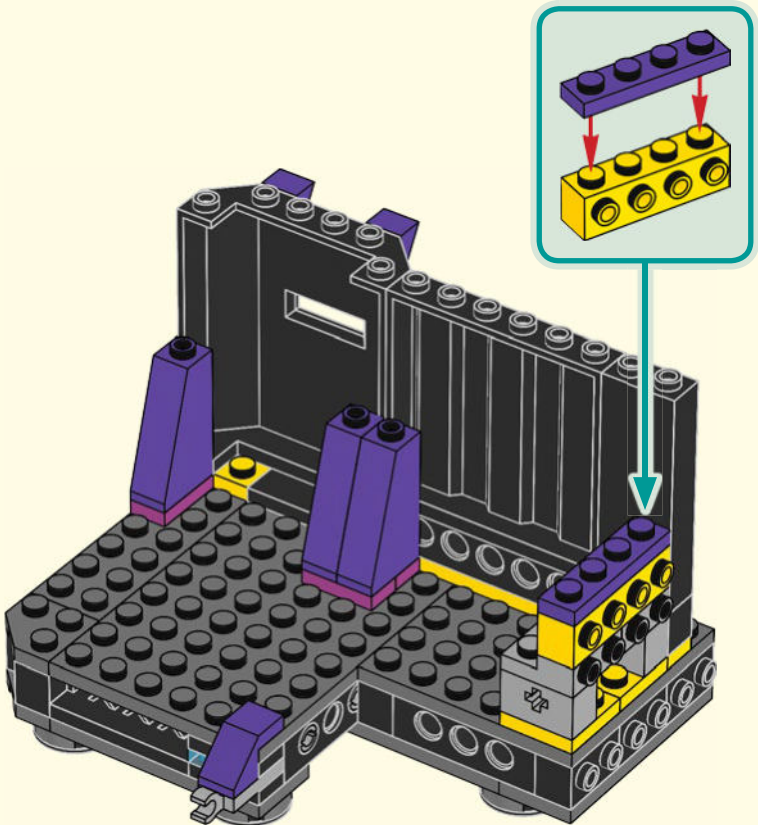

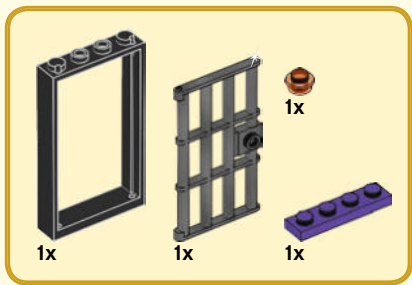

229

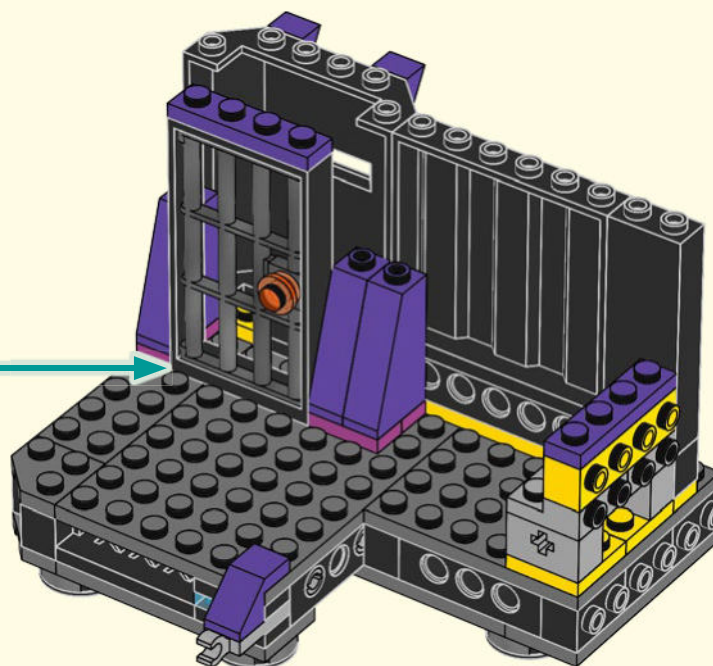
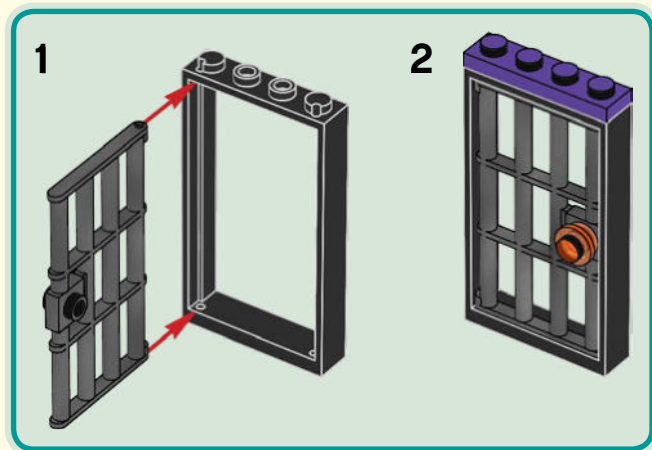

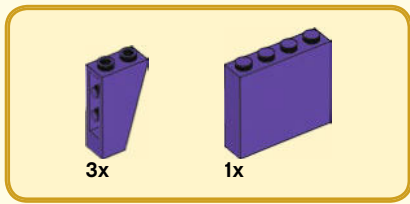

230

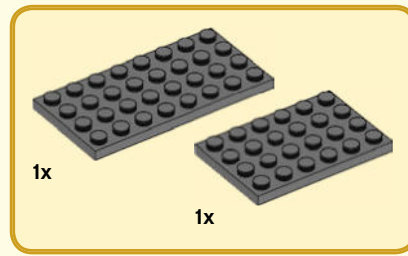
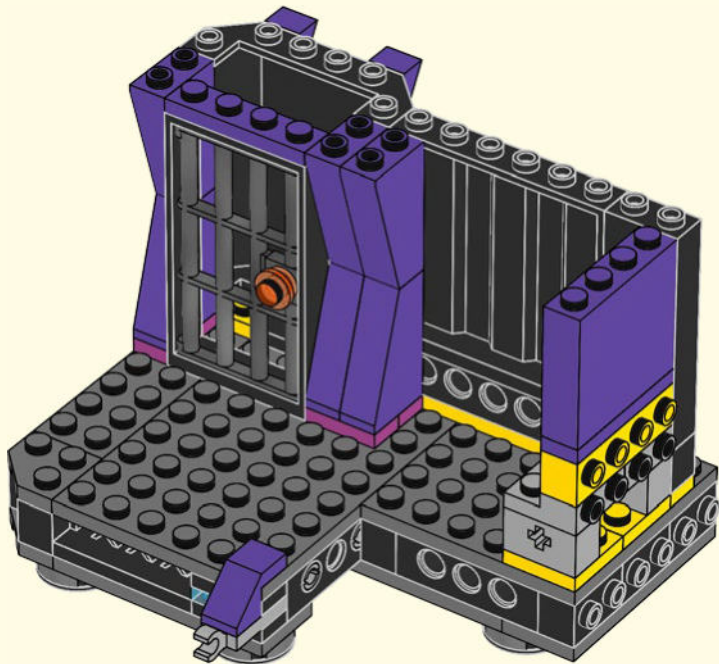

231

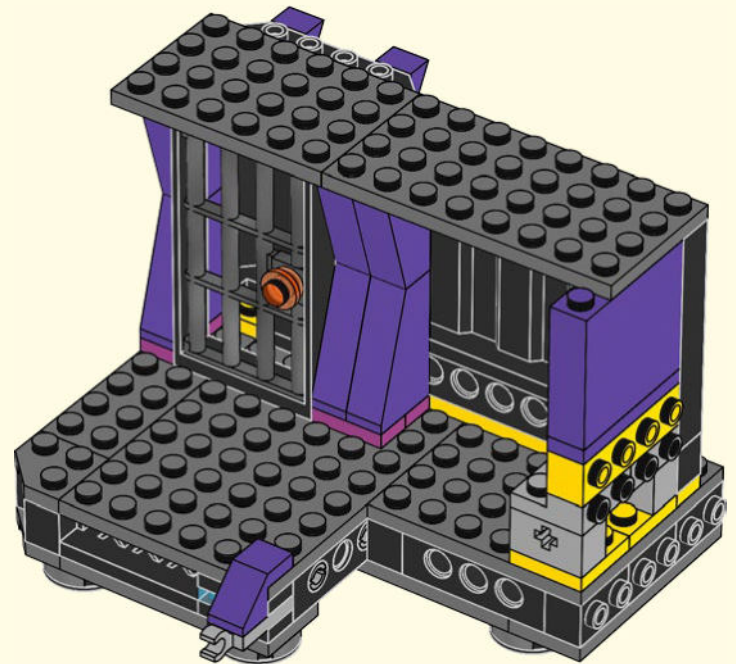



3x

232

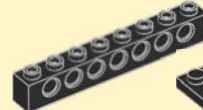
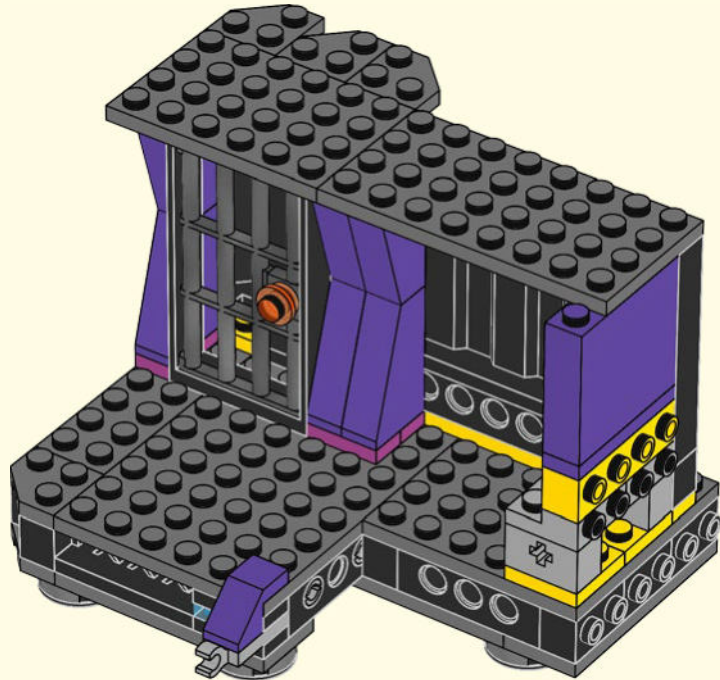

1x



1x



1x

233

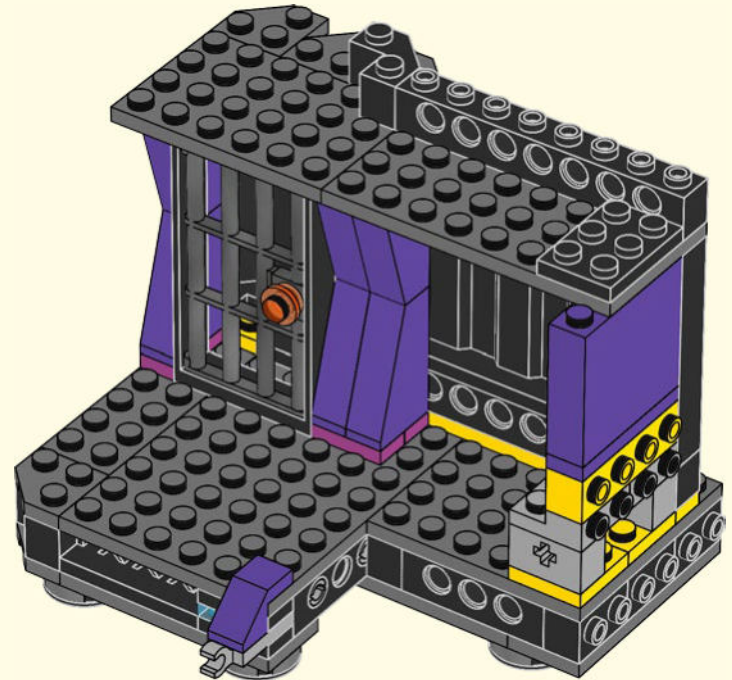





234

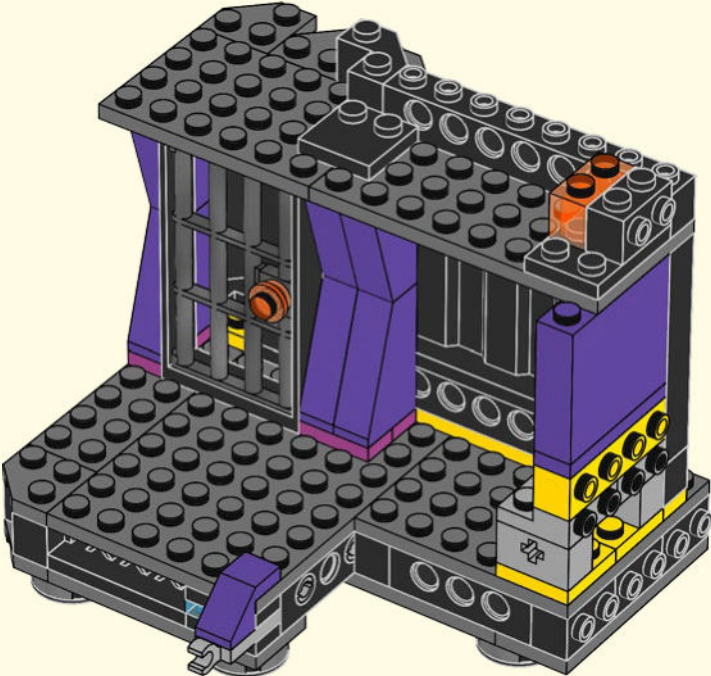

235

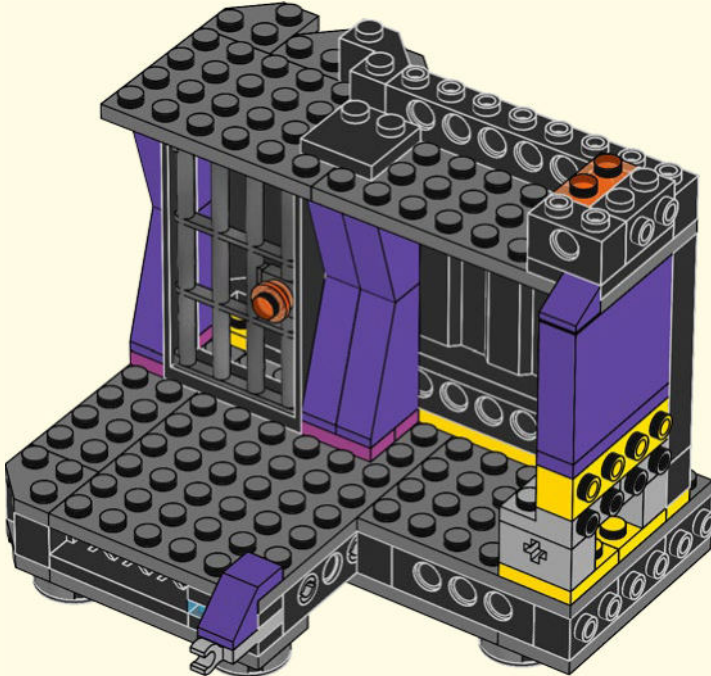



236

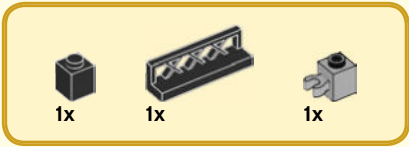
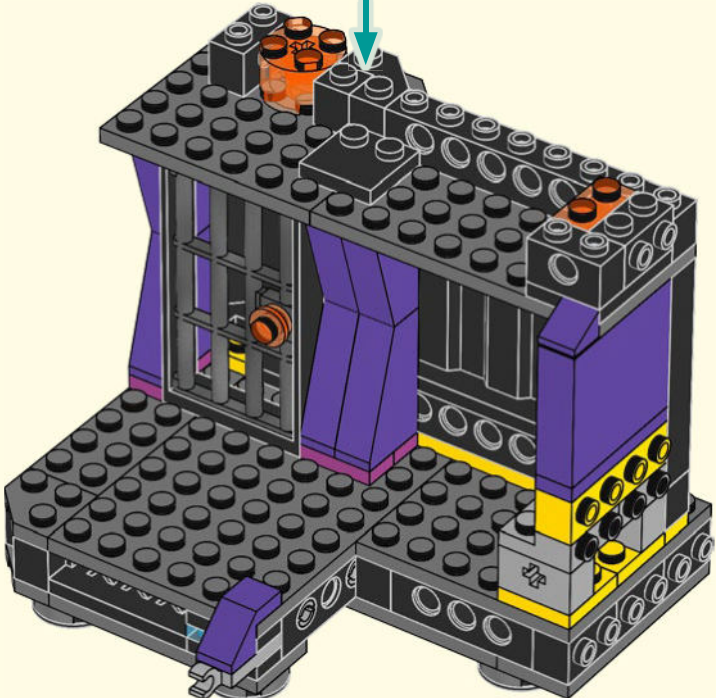

237

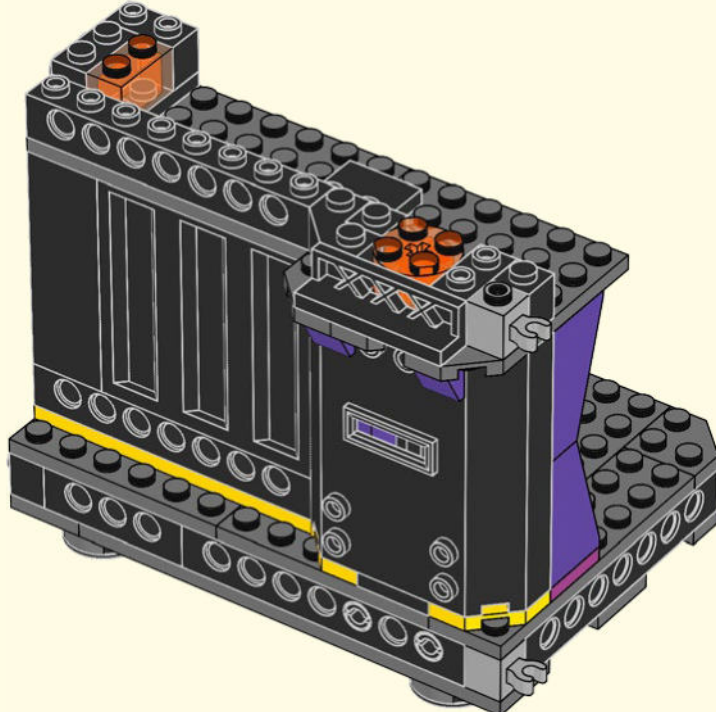

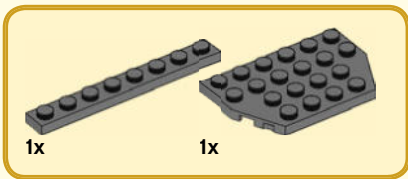

238

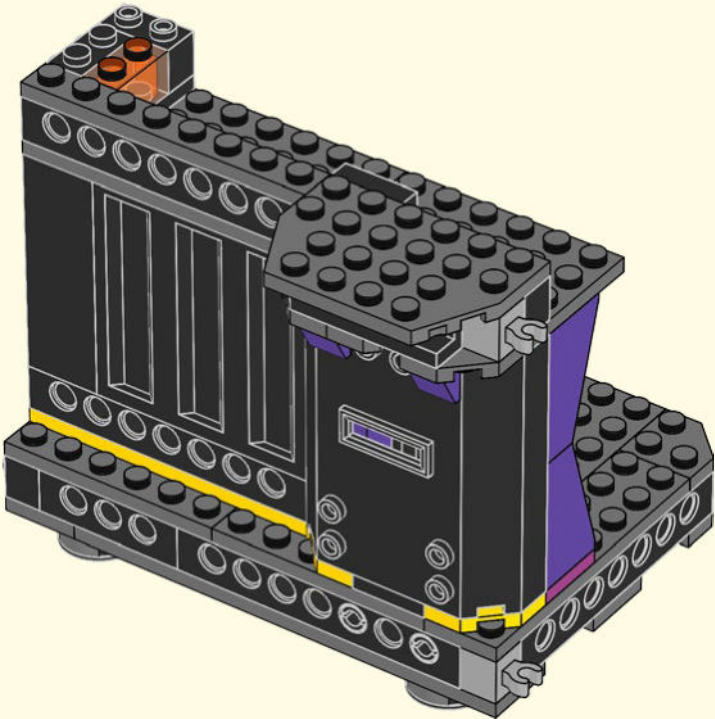

239

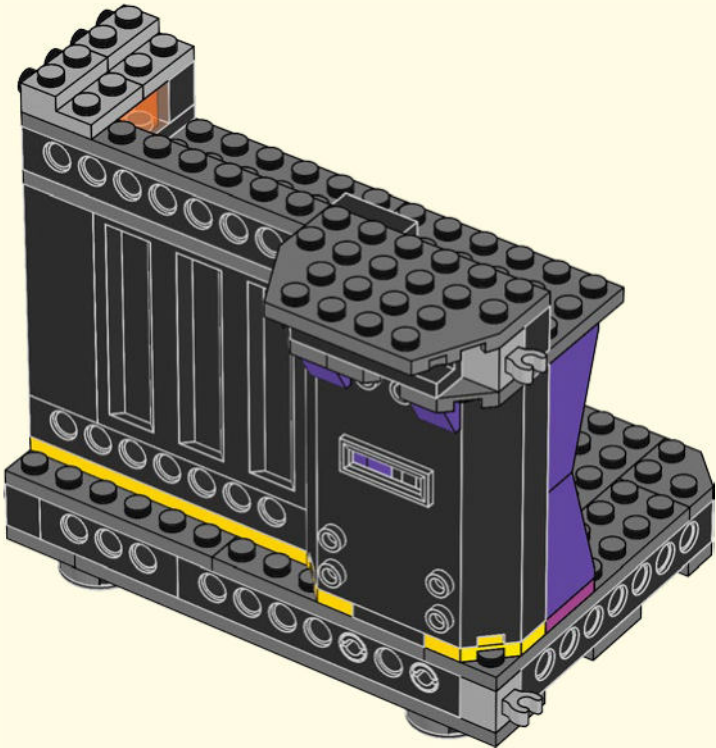

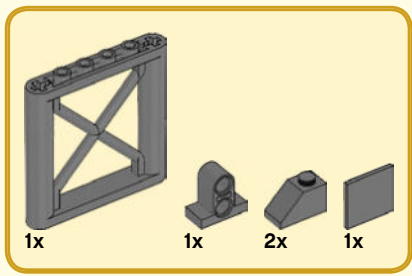

# 240

1

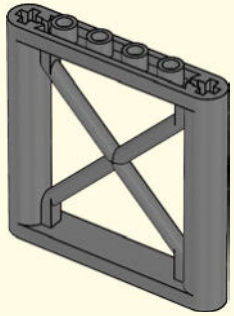

2

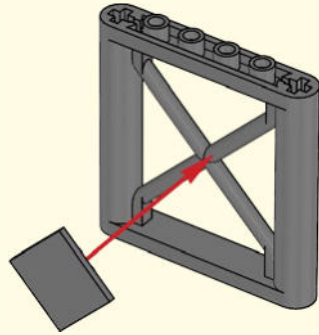

3

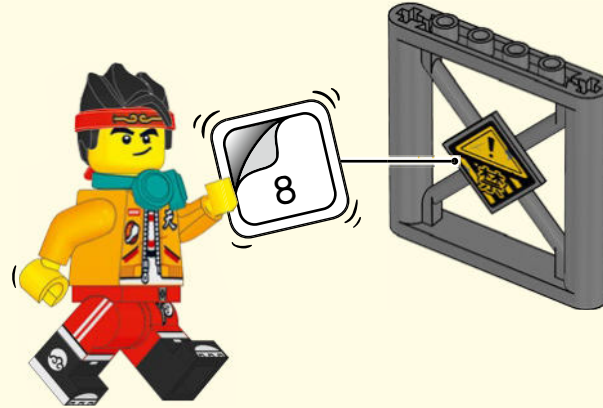

4



5

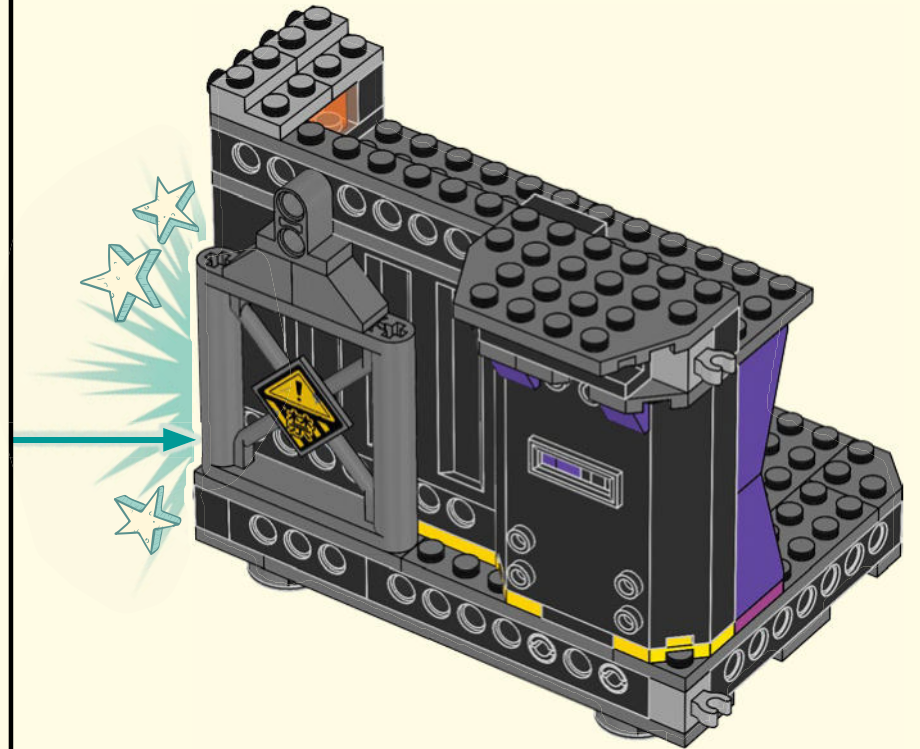
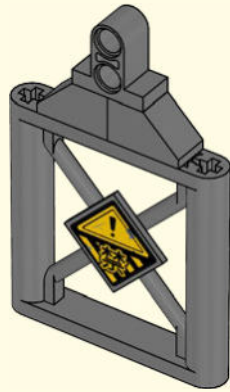



1x

241

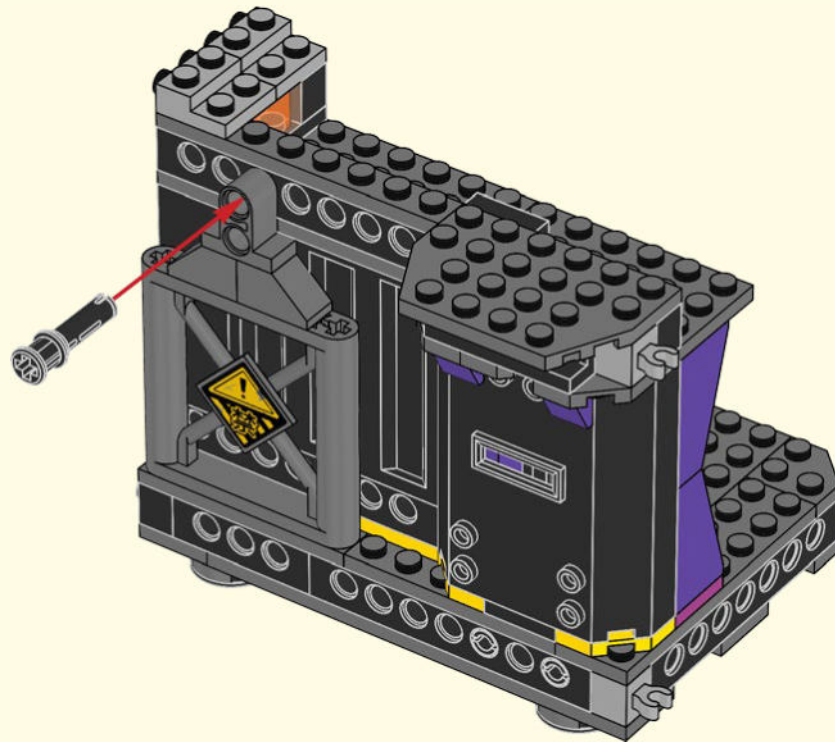



242

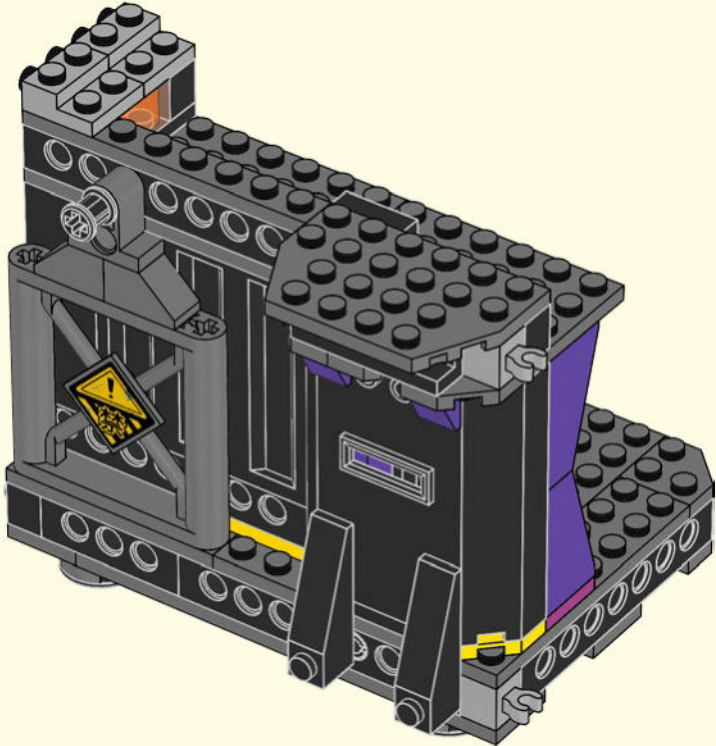



243

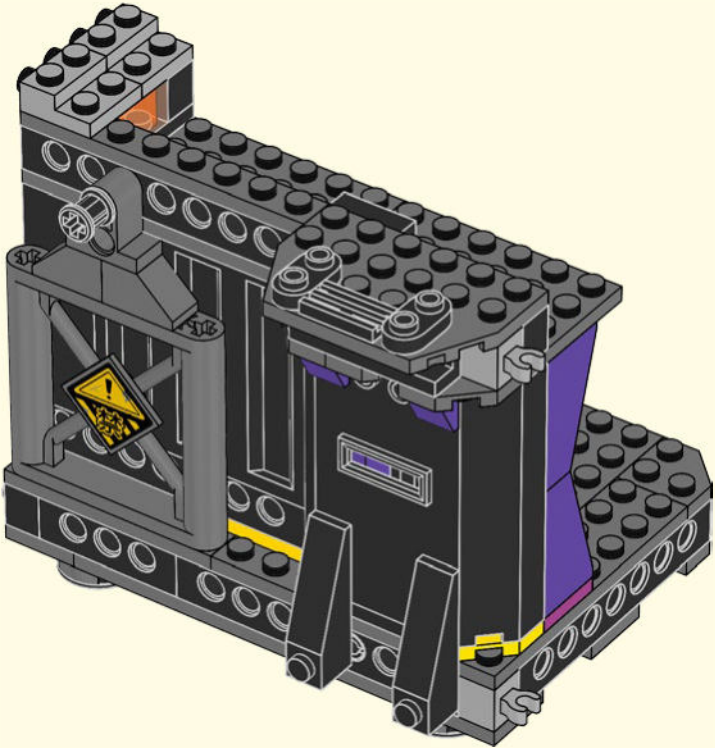





2x

244

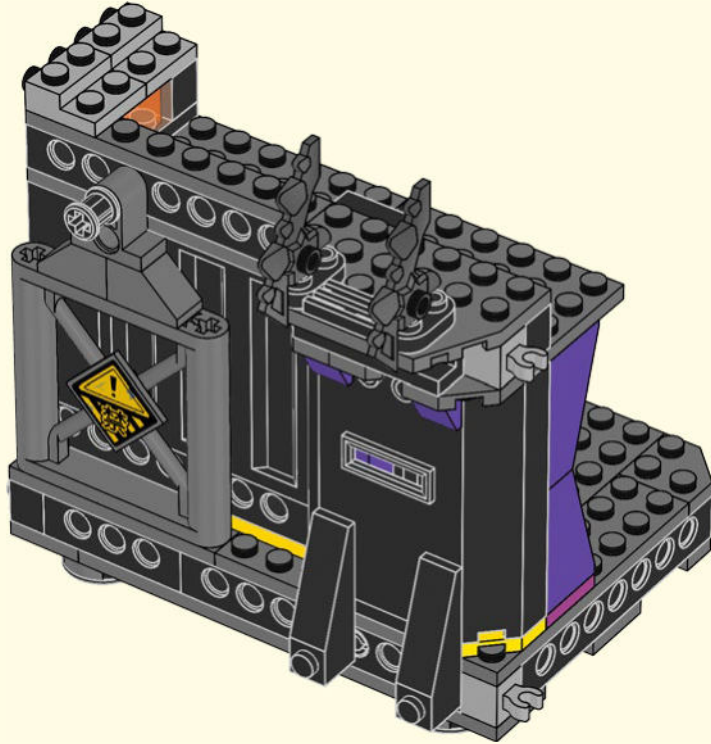

2x

245

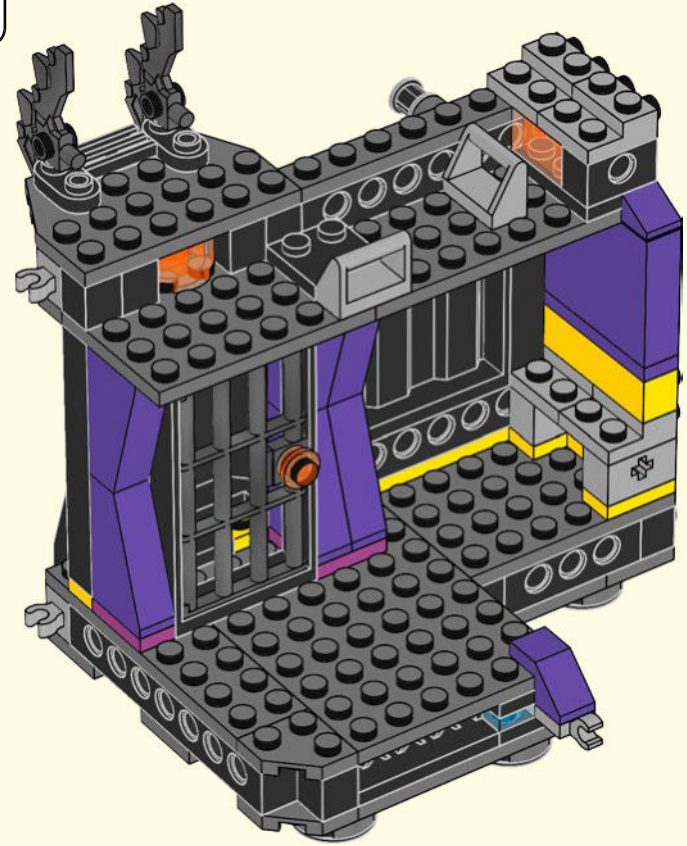
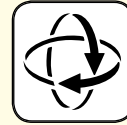

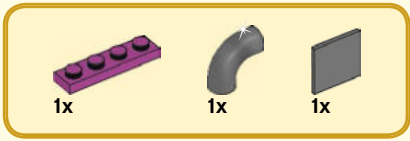

246

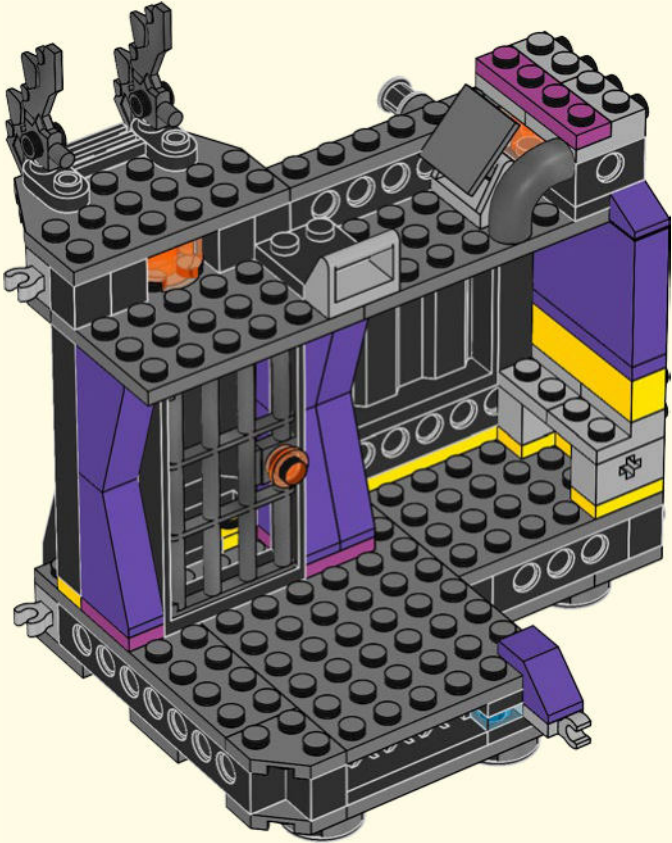



2x

247

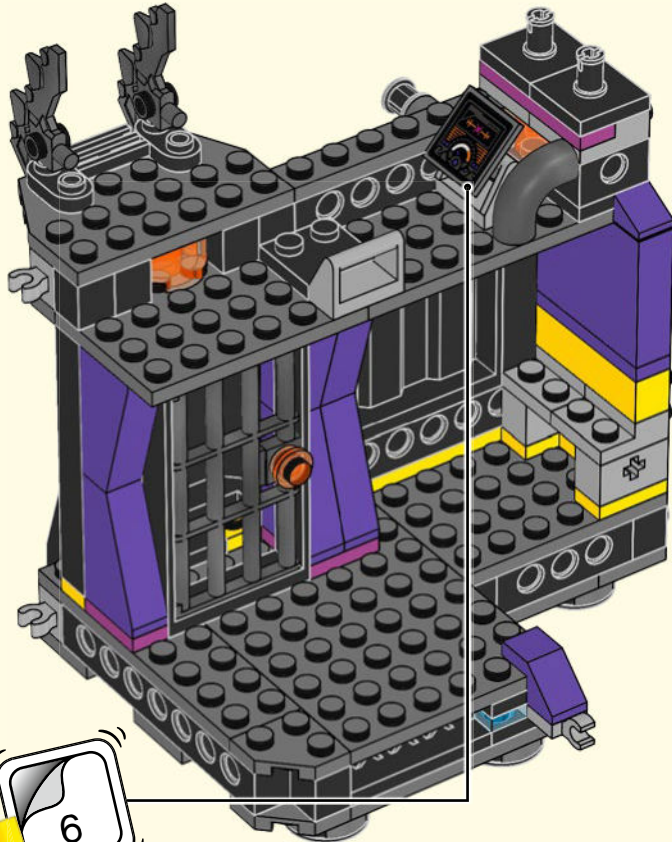

1x



1x

248

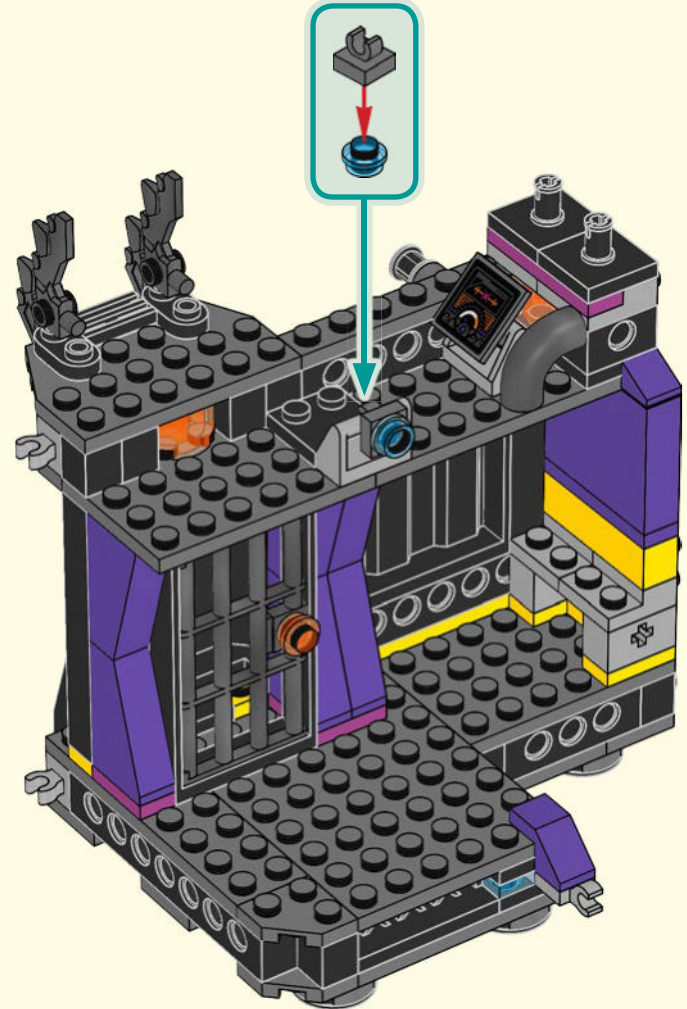

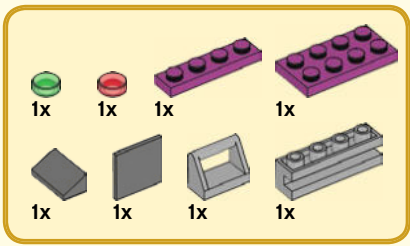

# 249

1

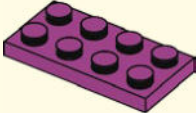

2

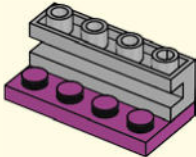

3

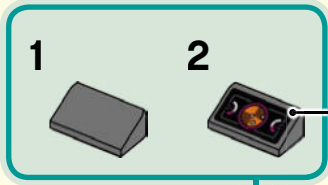
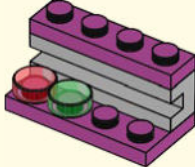

4

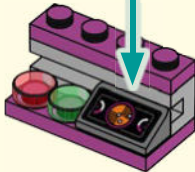

5



6



7



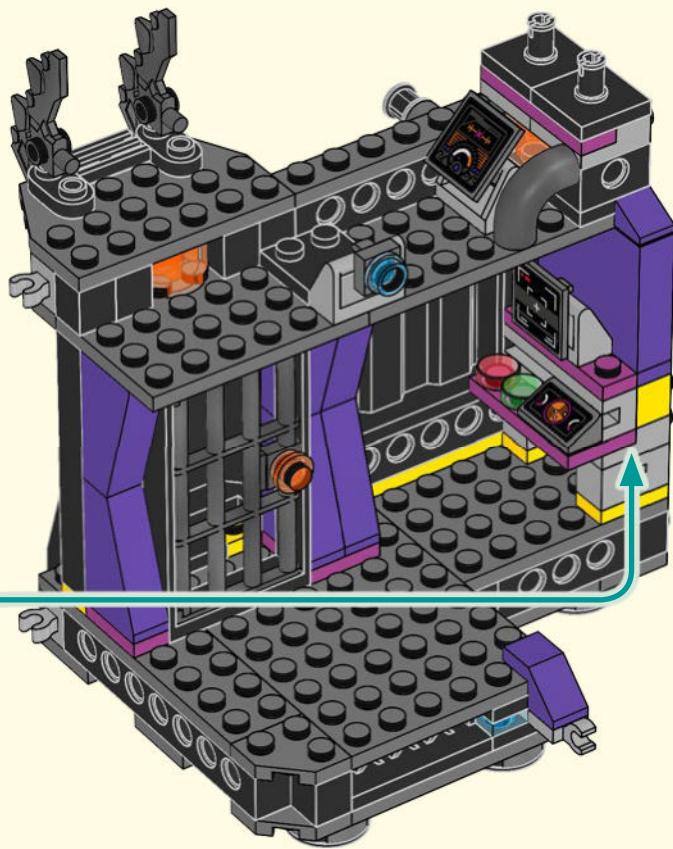

250

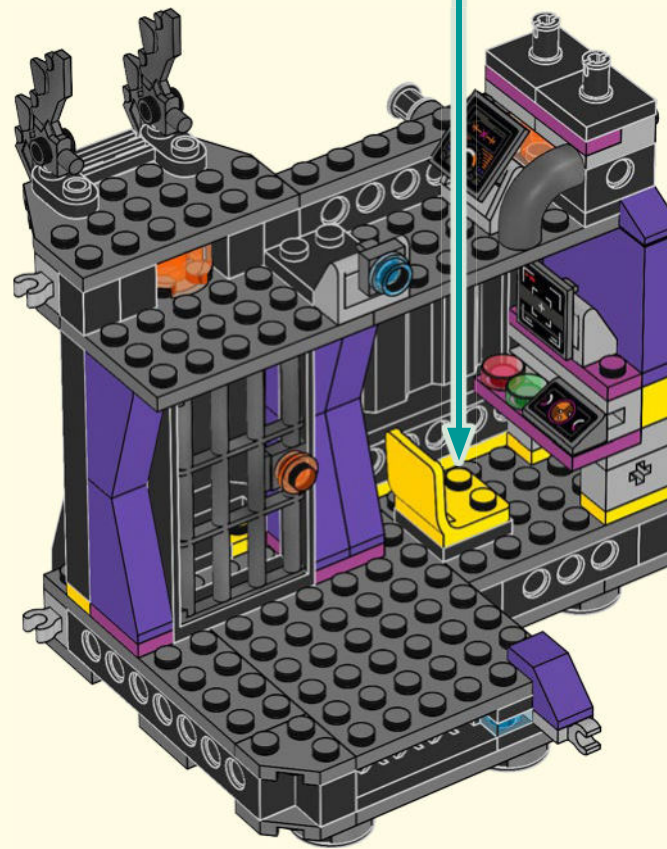
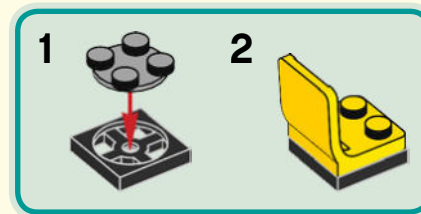



251

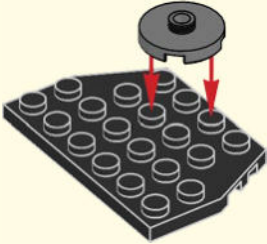

252



253

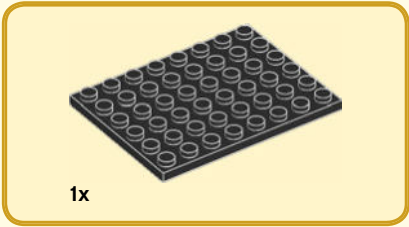
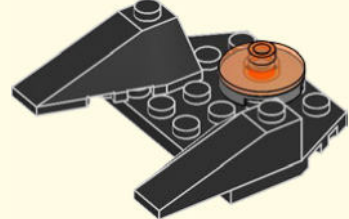

254

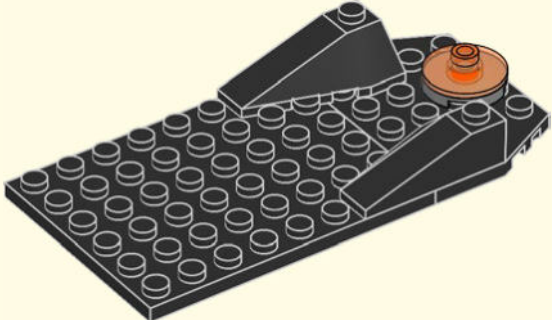



255

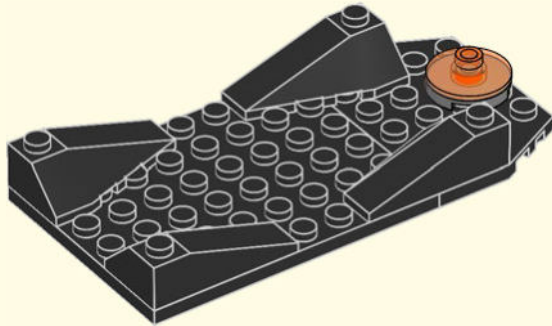

256

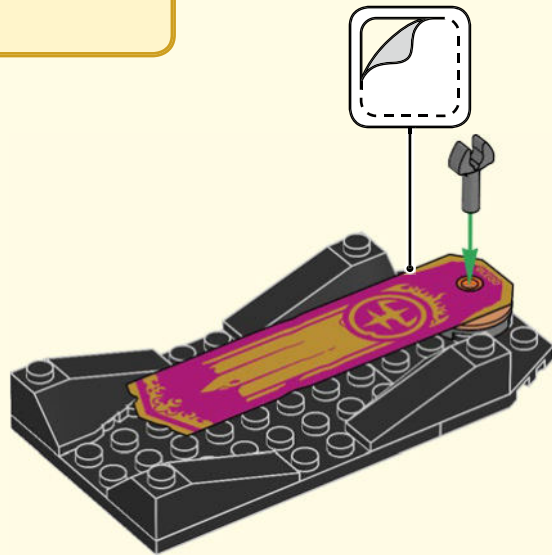

257

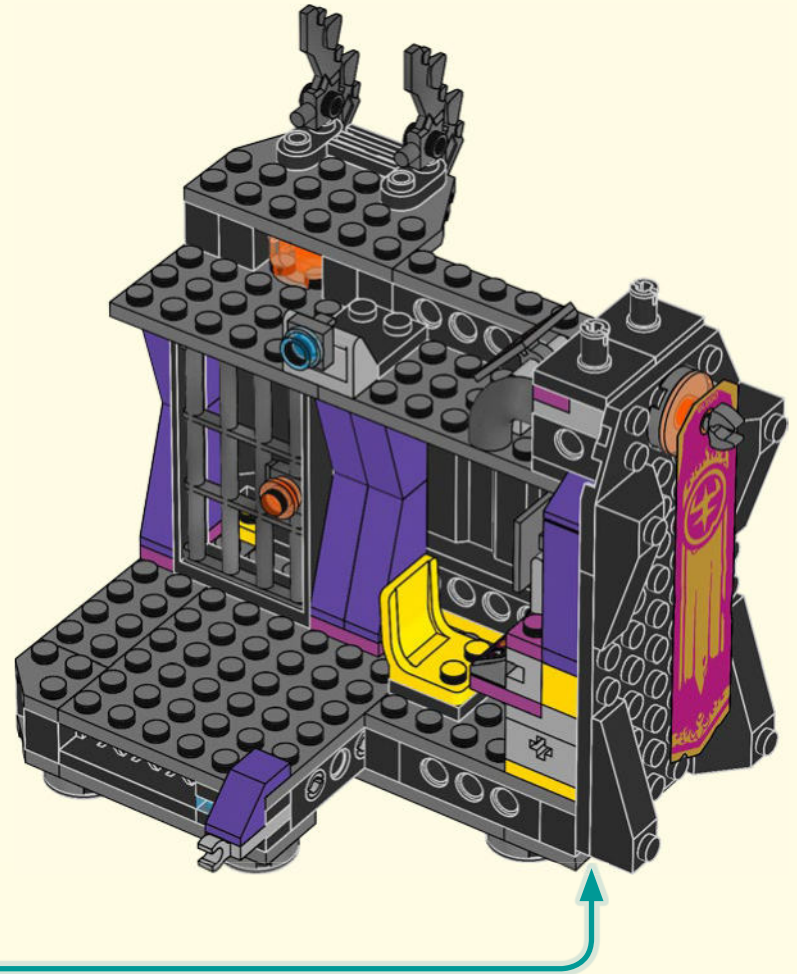



1x



2x

258

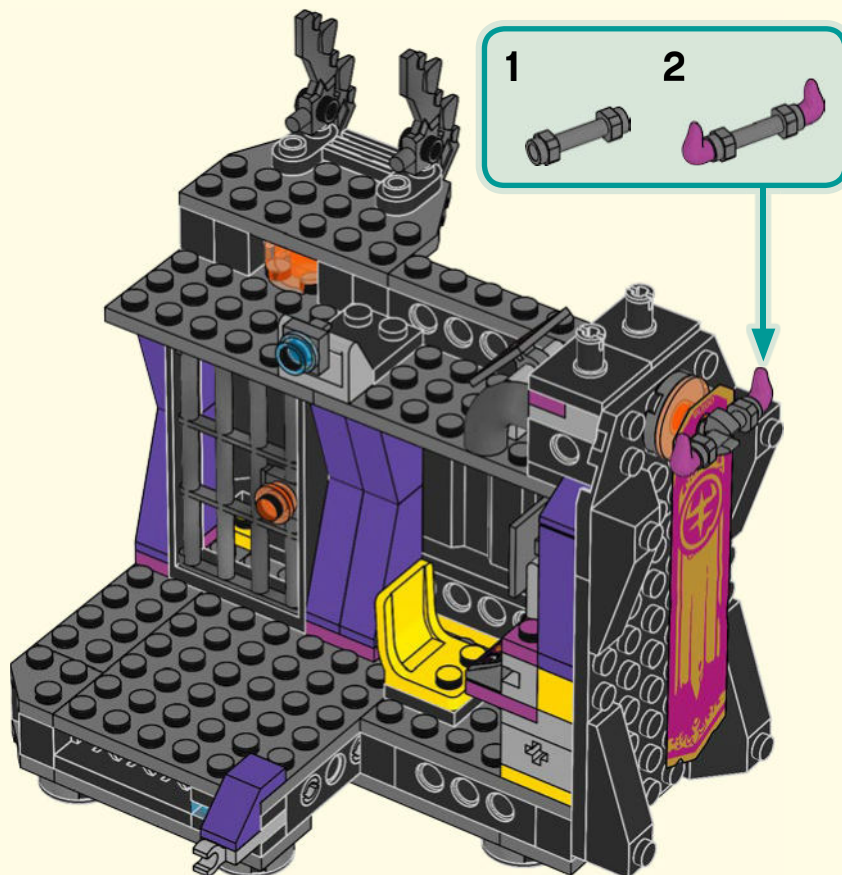





1x

259

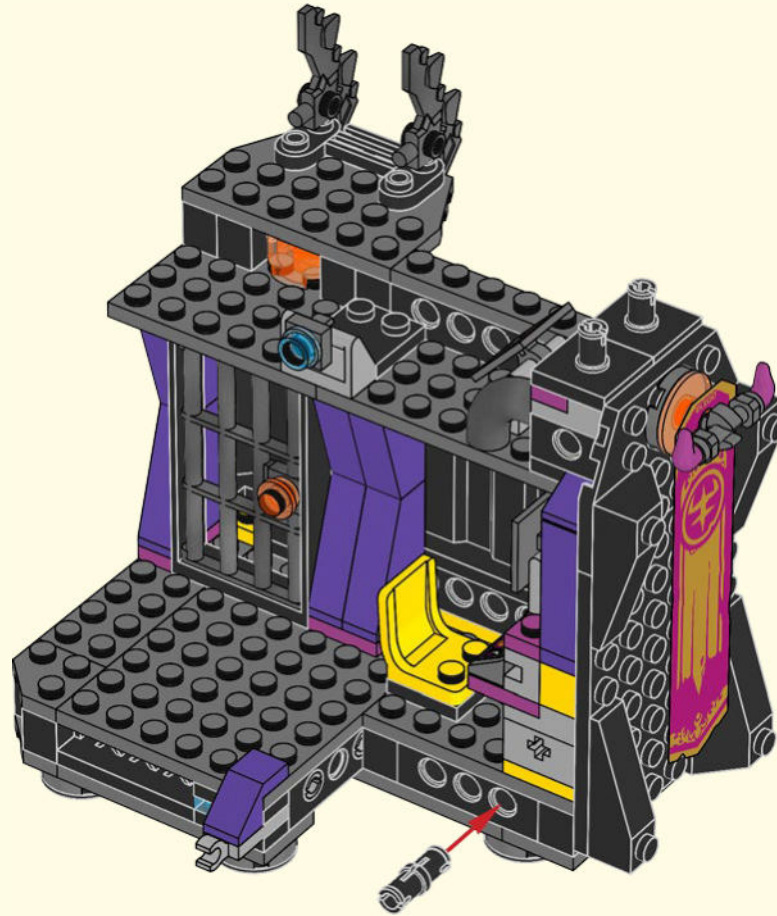



1x

260

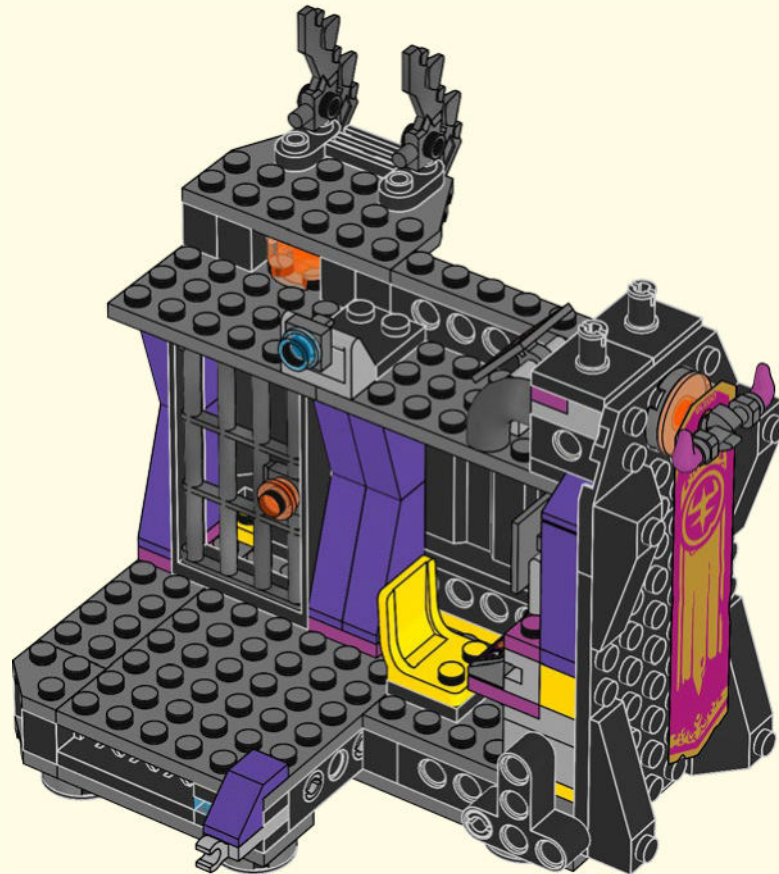

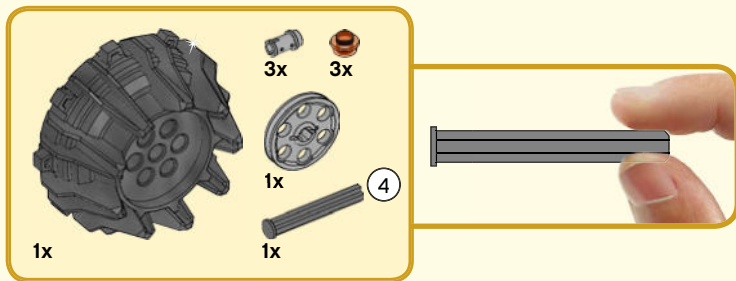

261

1

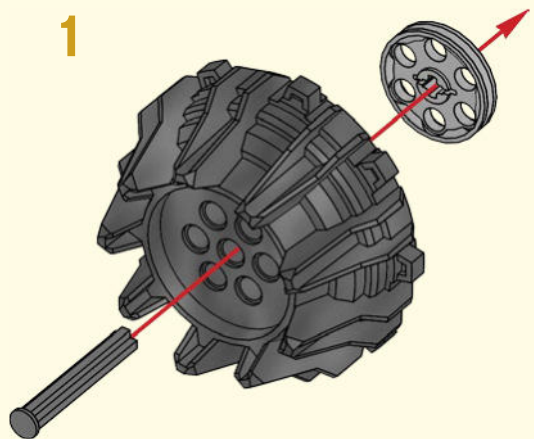

2

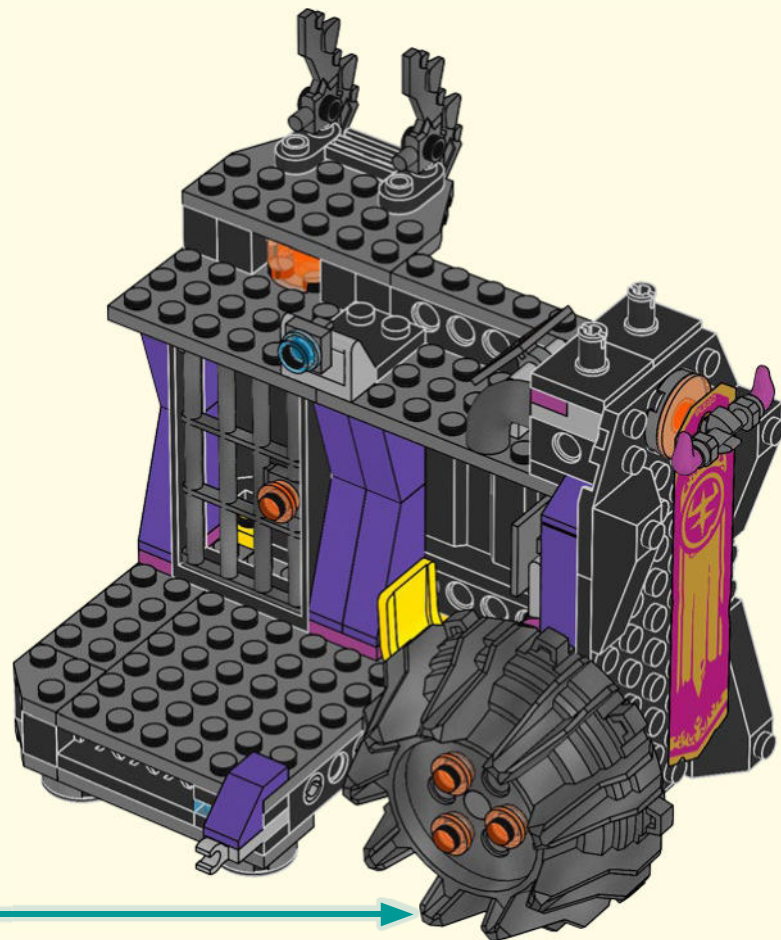
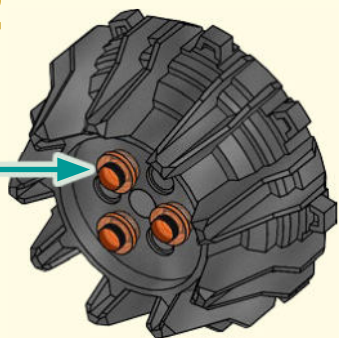
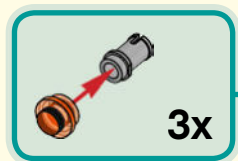



1x

262

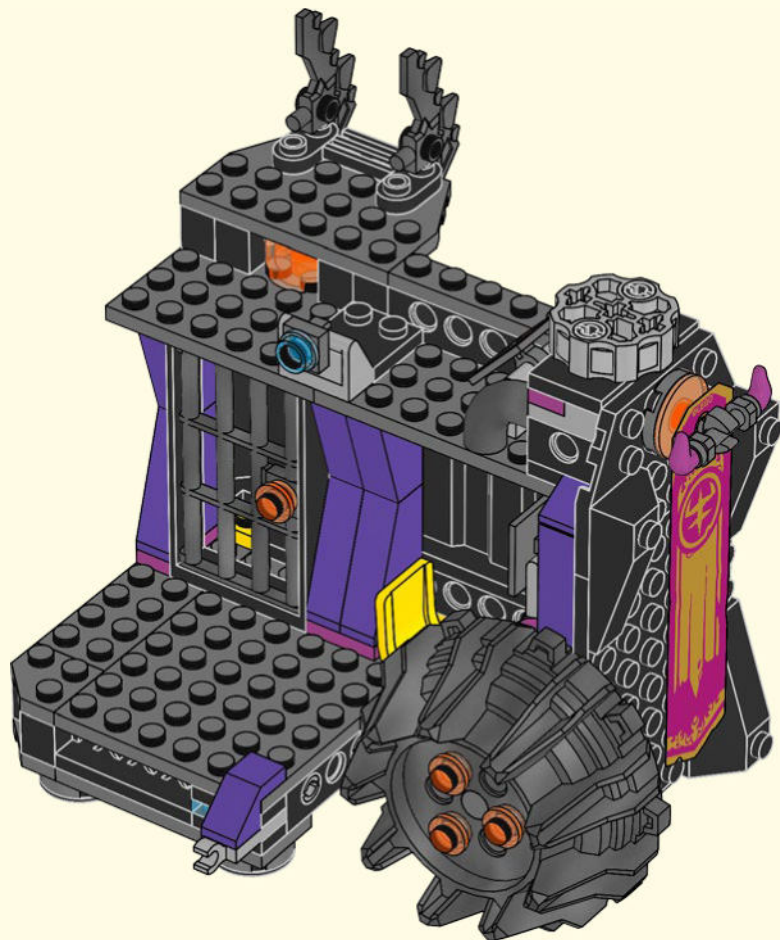



2x

263

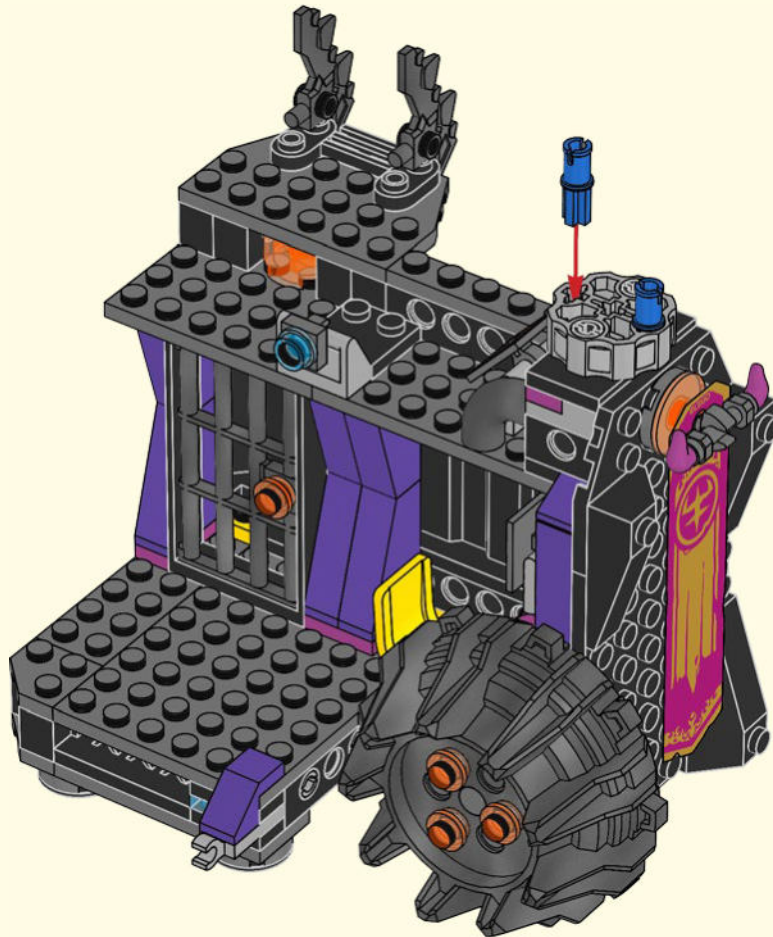

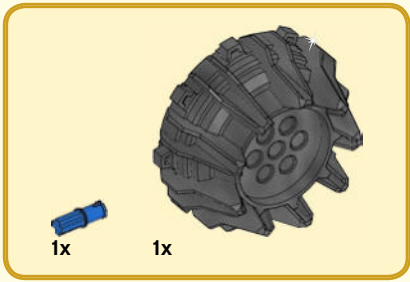

264

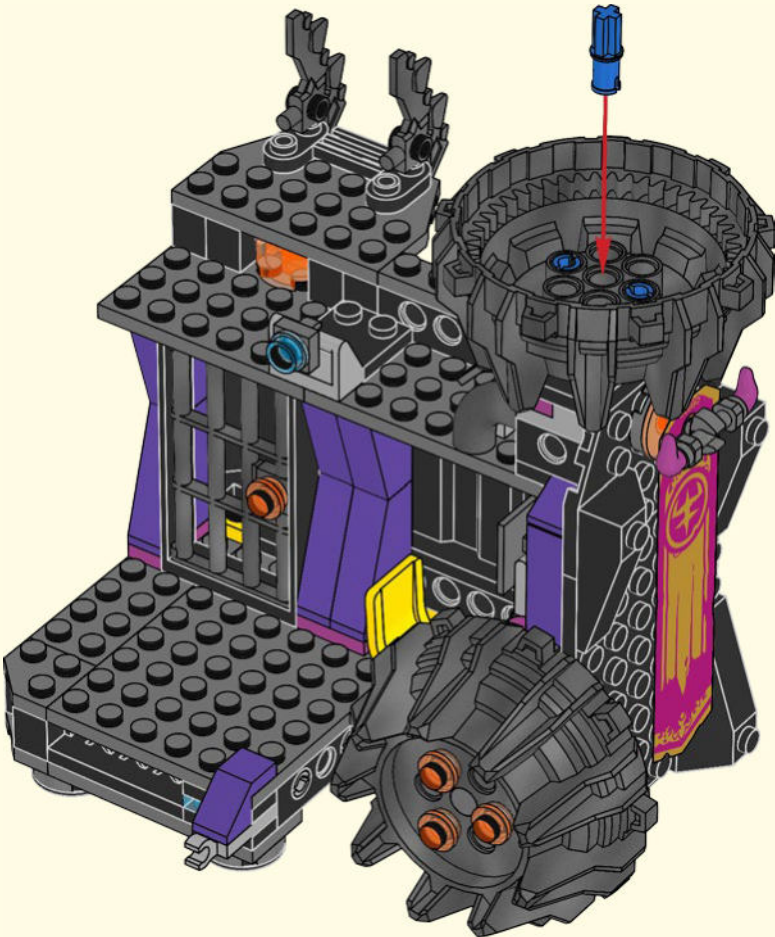



1x

265

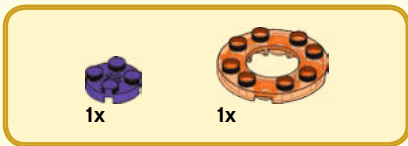

1x

1x

266



1x

267



2x

268



1x

2x

269

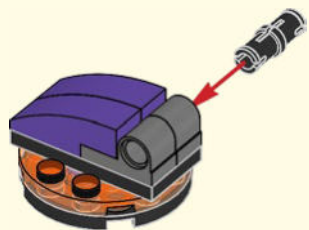

1x

270



271

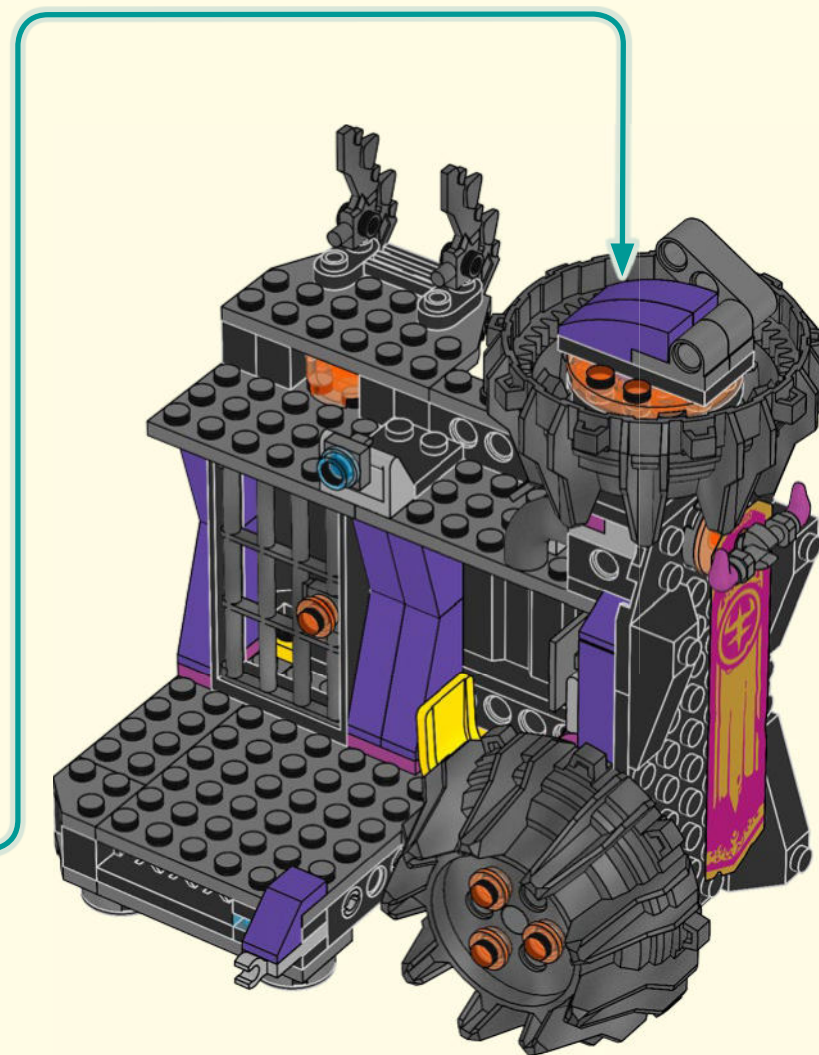



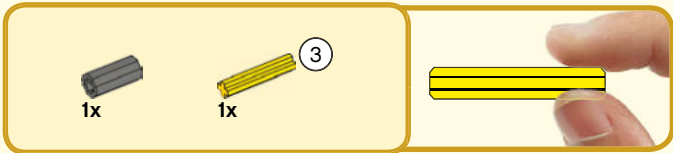

272

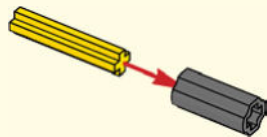

273

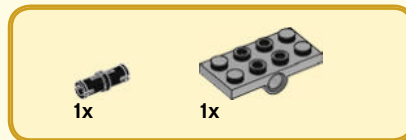
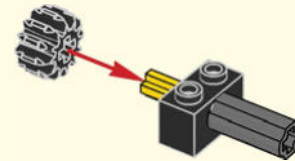

274

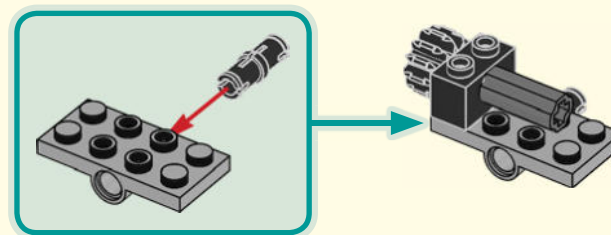

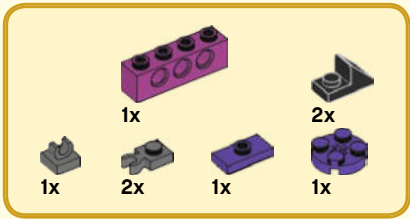

# 275

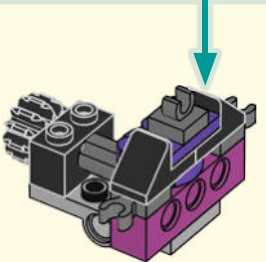
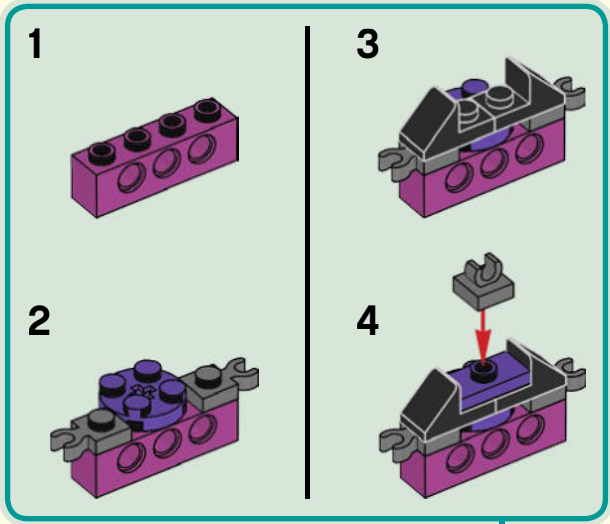

# 276

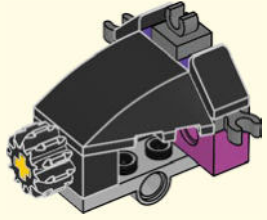

# 277

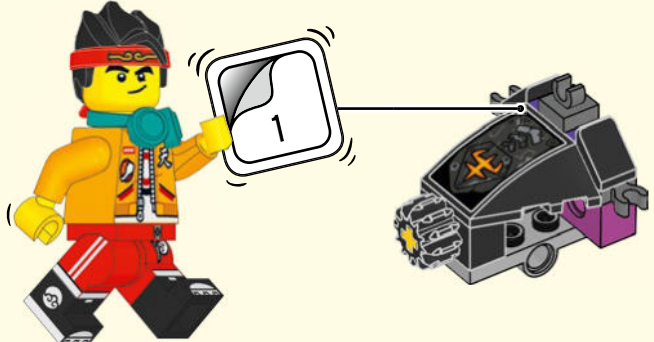



278

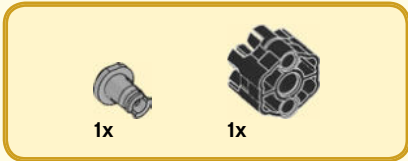
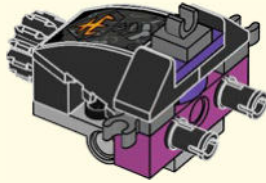

279

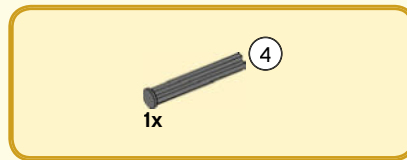
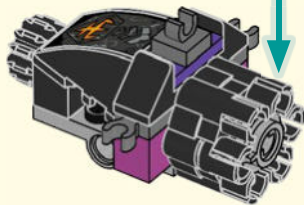
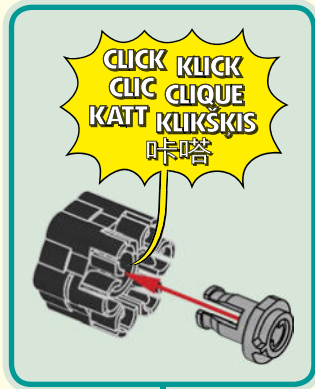

280

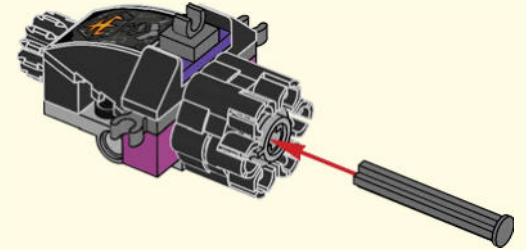
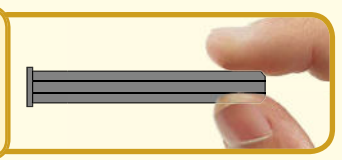

281

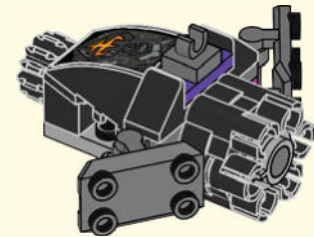

282

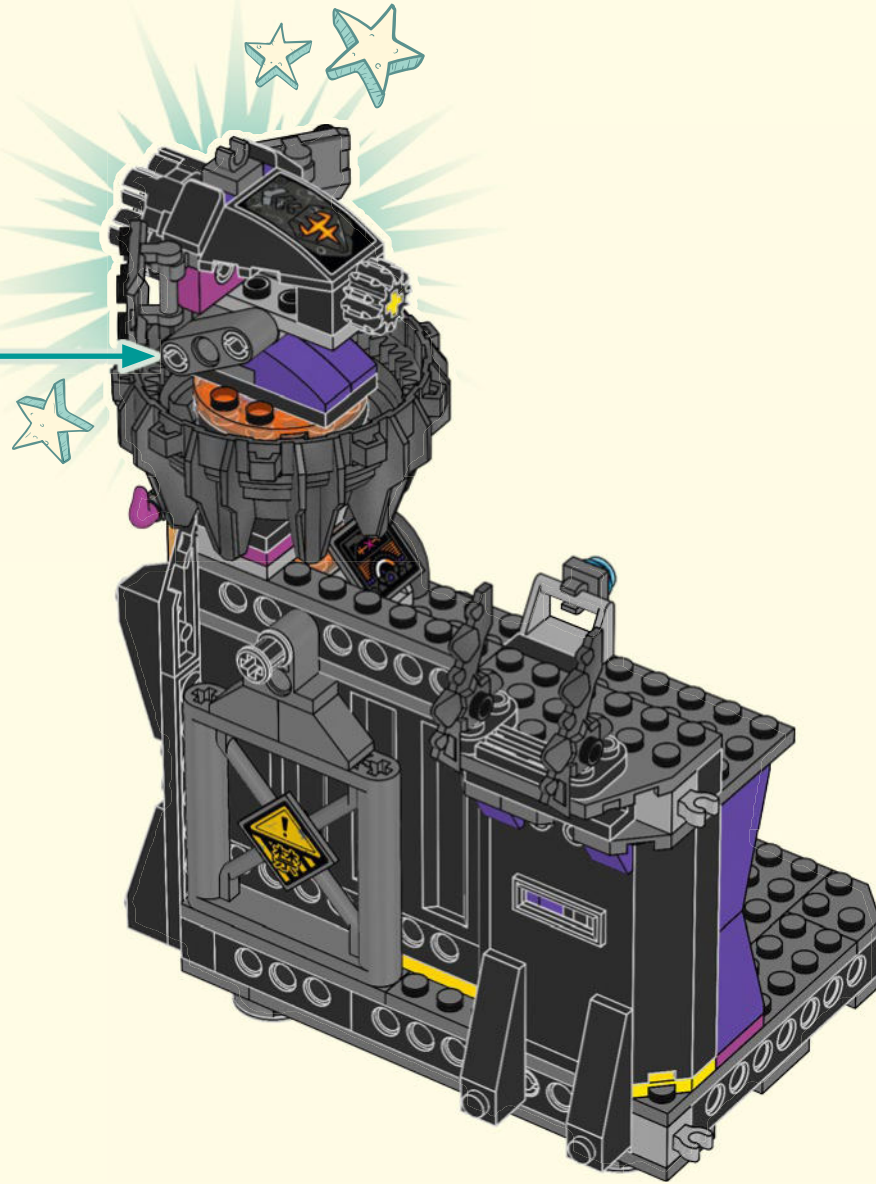

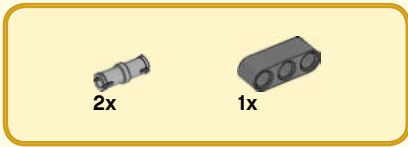

283

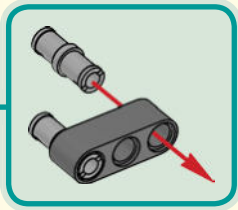
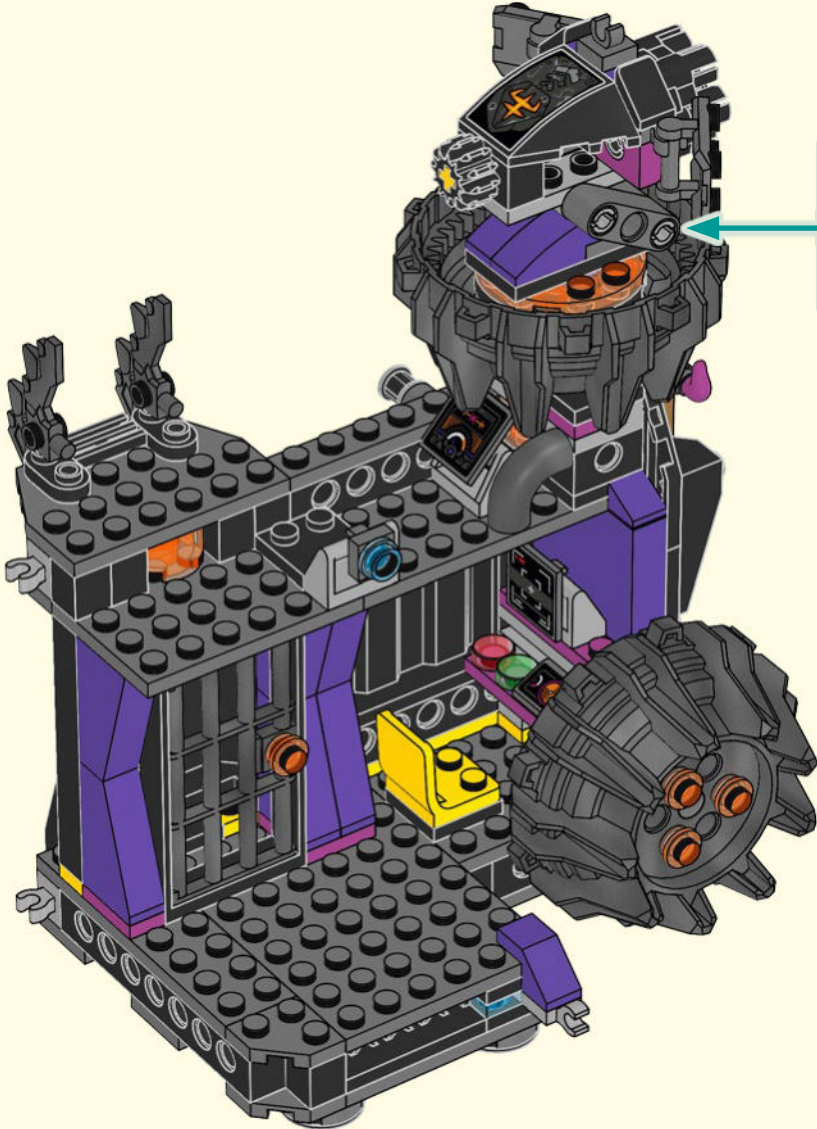



1x

284

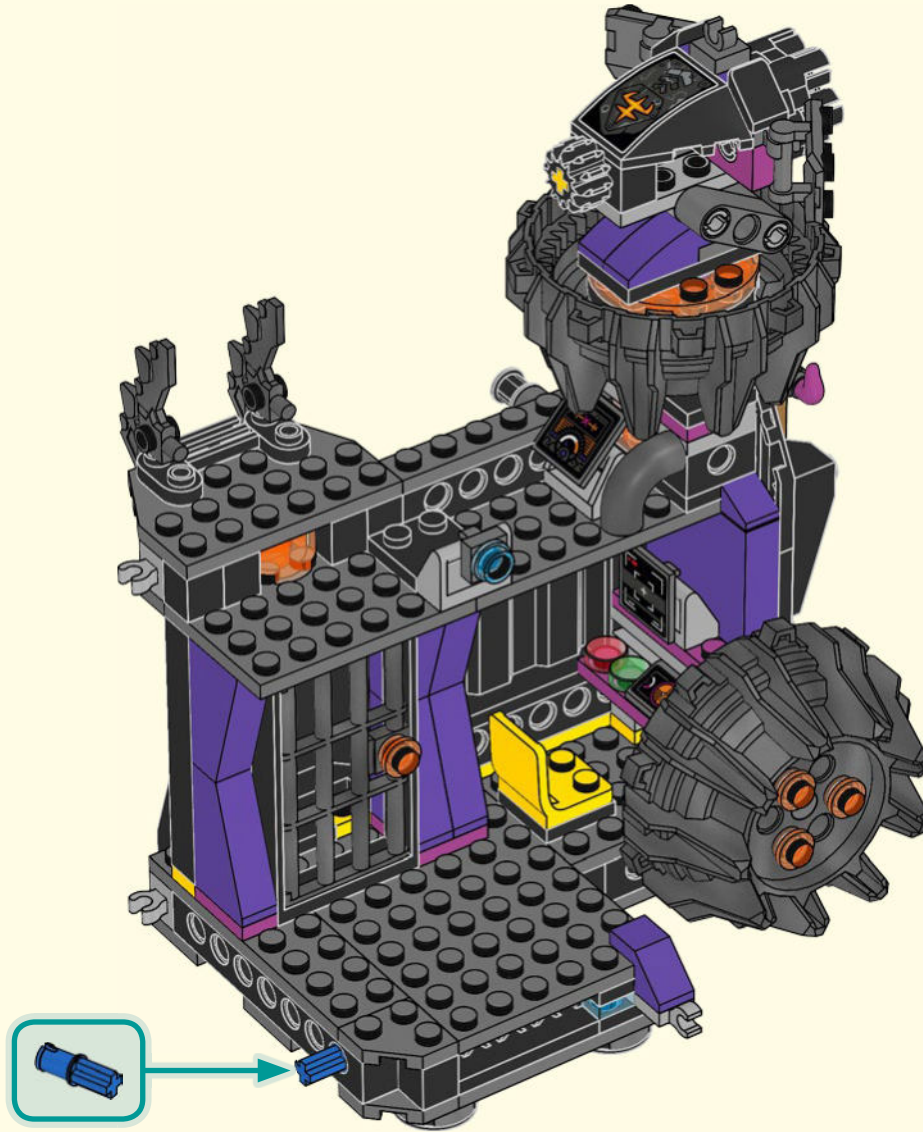

285

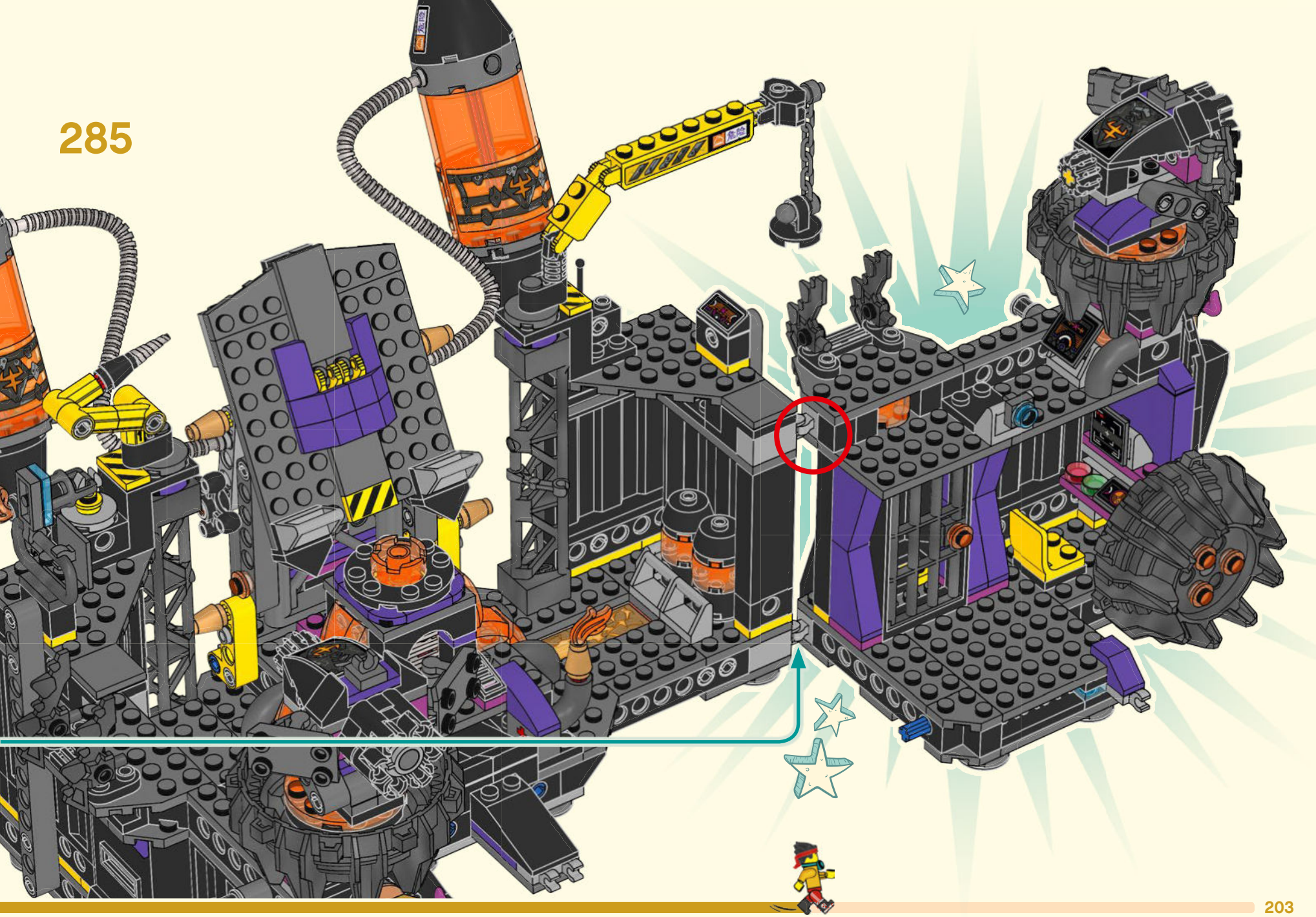

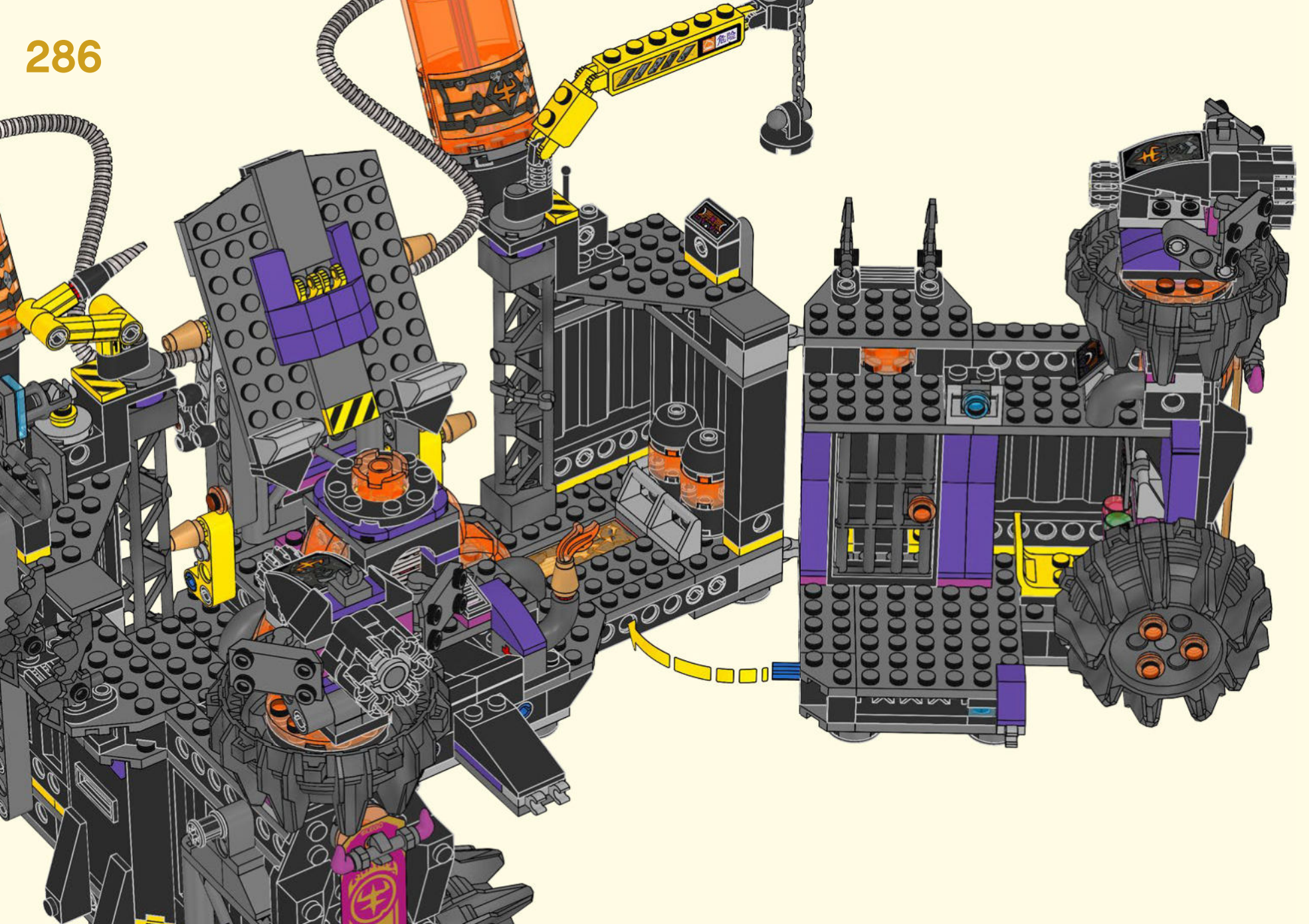



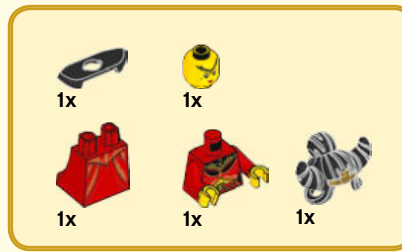

1

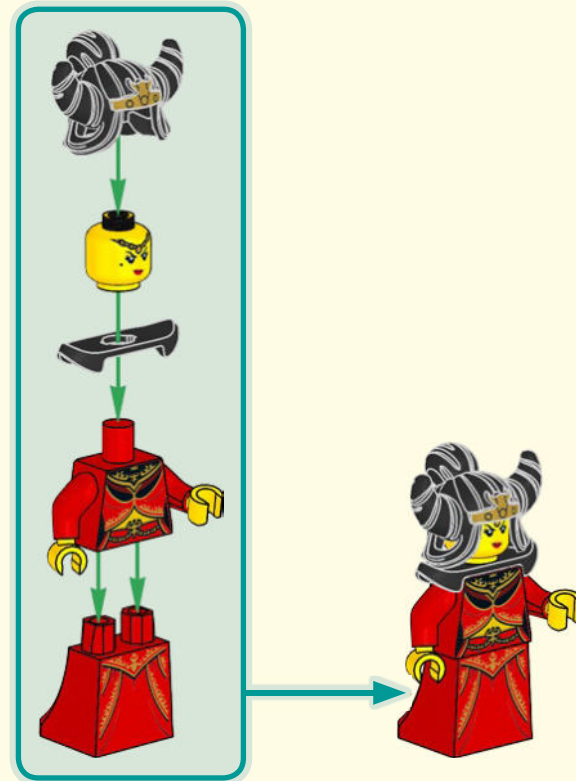

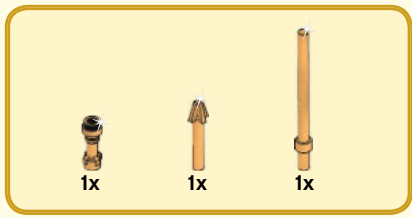

2

1



2

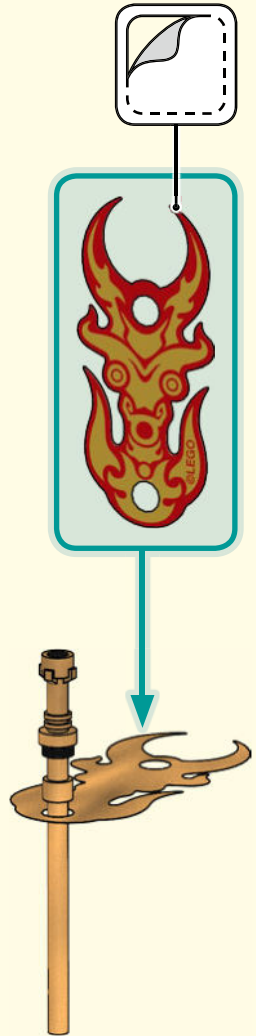

3

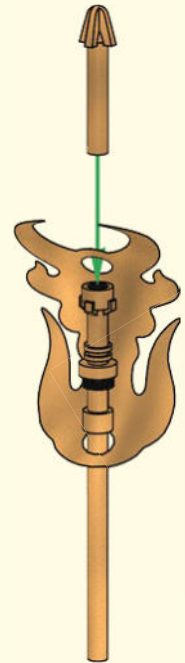



1x

1



2x

2

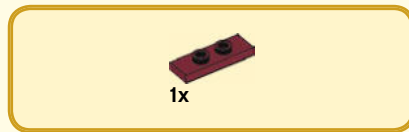
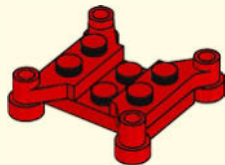

1x

3

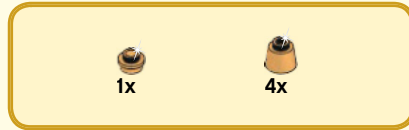
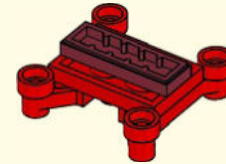
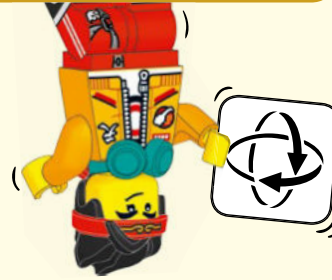

1x

4x

4

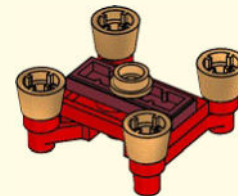



2x

5

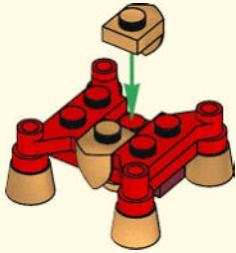

1x



1x

6

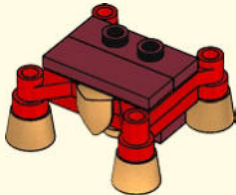

4x

7



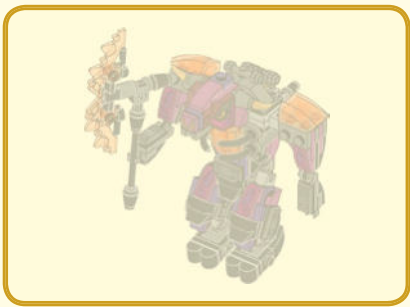

1



2



3



4





2x

5

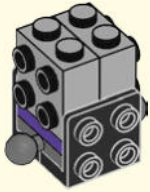

1x

6

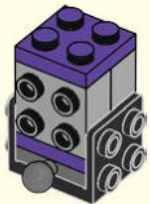

1x



1x

7

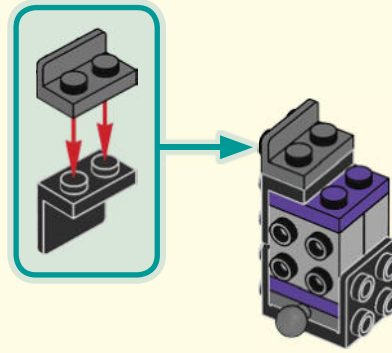

1x



1x

8

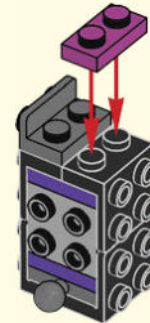

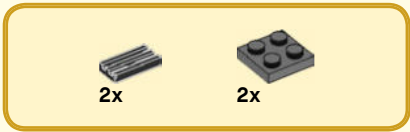

9

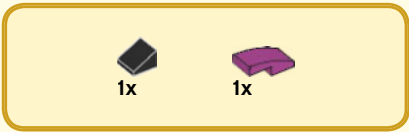
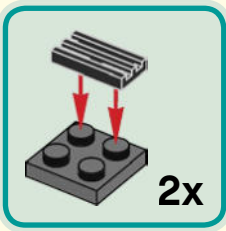

10

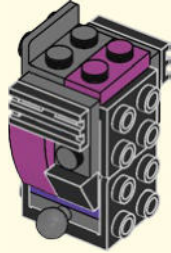

11



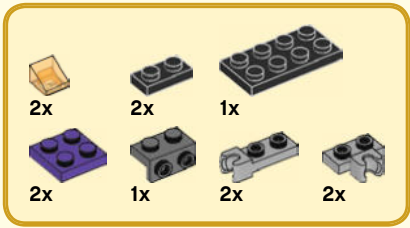

# 12

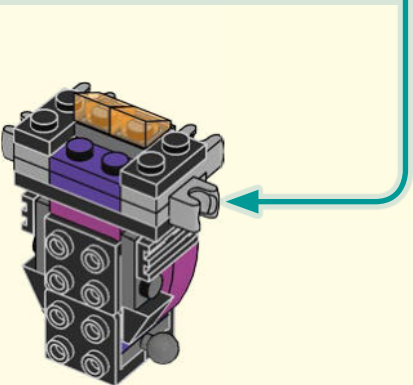
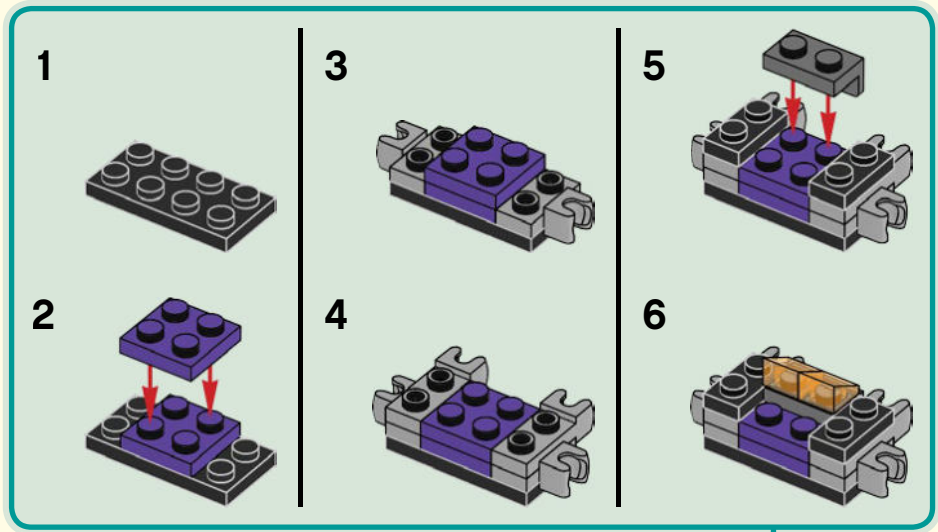

# 13

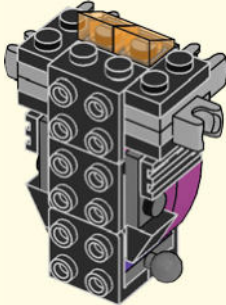

# 14

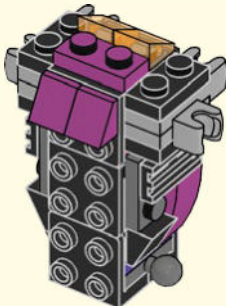





1x

15

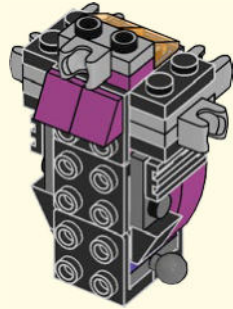

2x

16

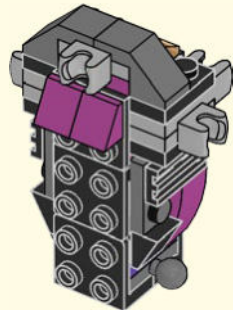

2x

17

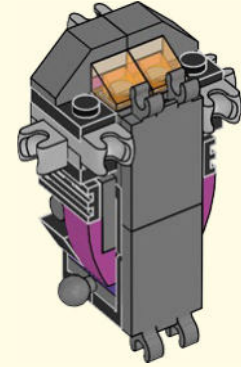
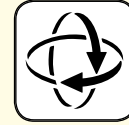

4x

18

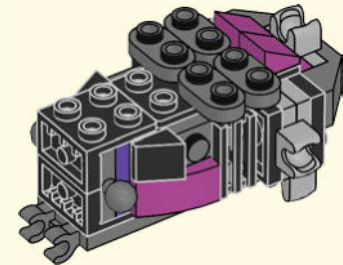
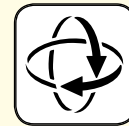



1x



1x

19

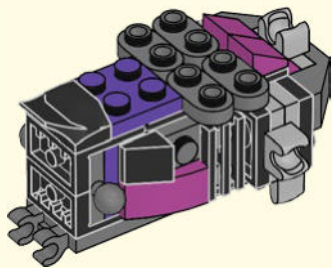

1x



1x

20

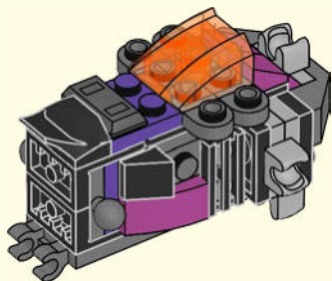

4x

21

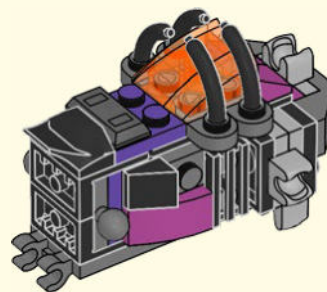



22

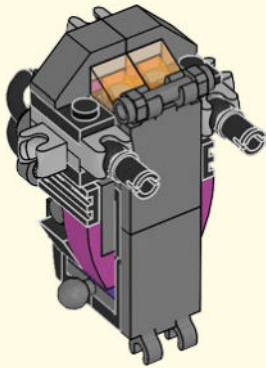

23

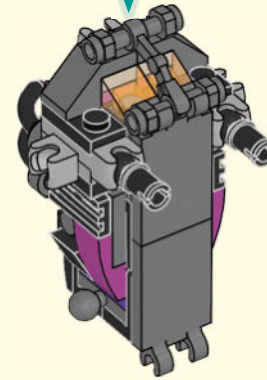
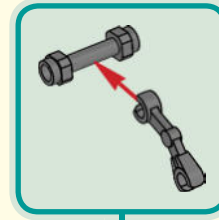



24



25

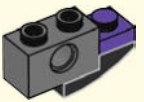



1x

26

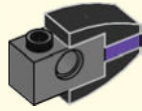

1x



1x

27

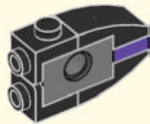

1x

28

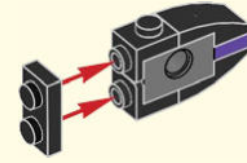

2x



1x

29

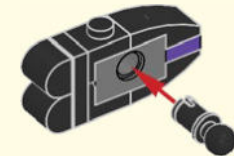



1x

30



1x

31



1x

32

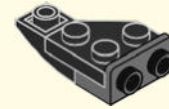

1x



1x

33

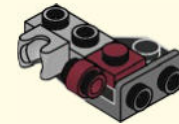



1x

34

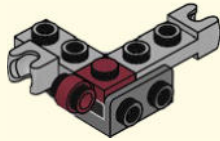

1x

35

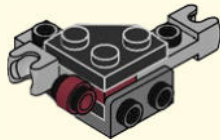

1x

36



1x



1x



1x

37

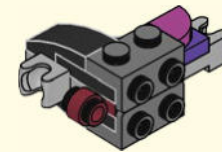



1x

38

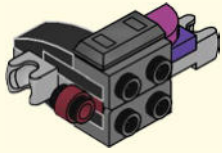

1x



1x

39

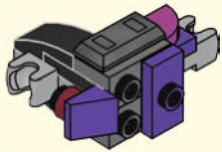

1x



1x

40



41

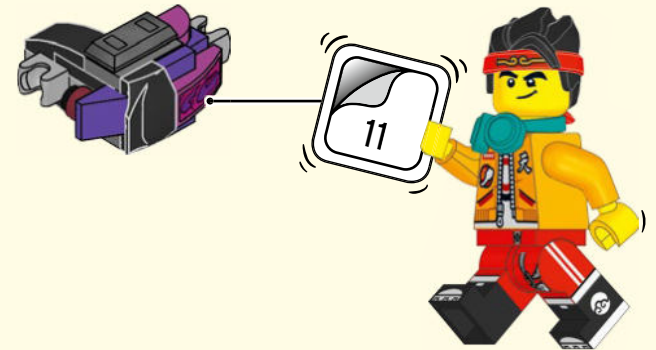



42



43





44



45

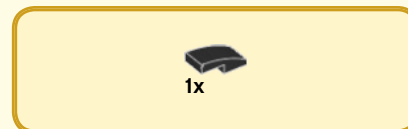
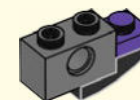

46





1x



1x

47



1x

48

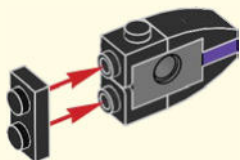

2x

49

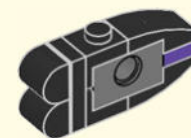

1x

50

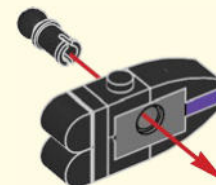



1x

51



1x

52



1x

53



1x



1x

54





1x

55

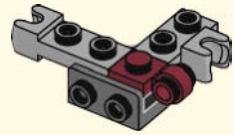

1x

56

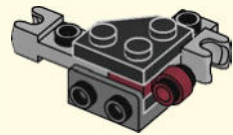

1x

57

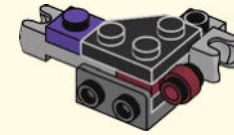

1x



1x



1x

58

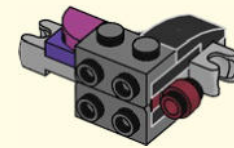



1x

59

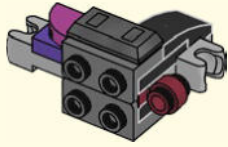

1x



1x

60



1x



1x

61

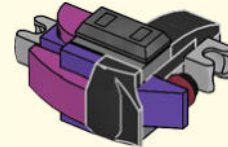

62

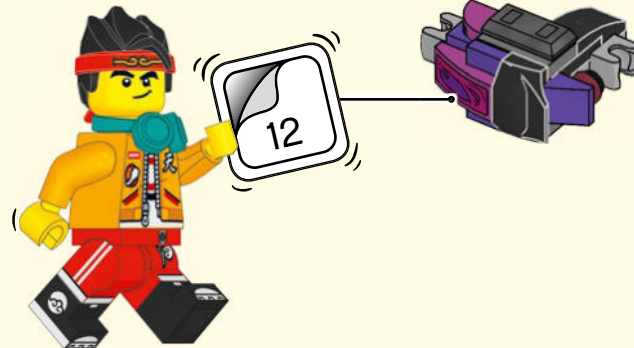

63



64





1x

65



1x

66



1x

67







68



69



70

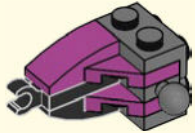

71



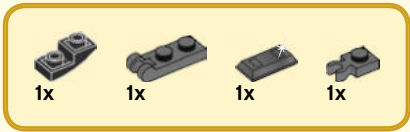

72

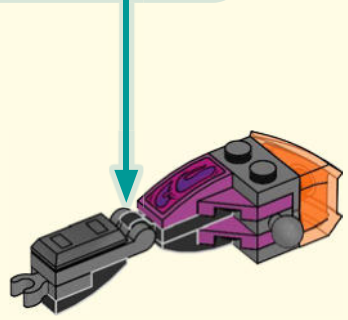
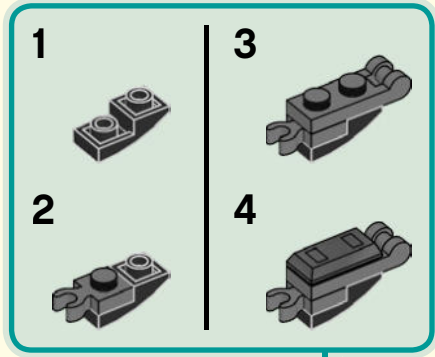

73

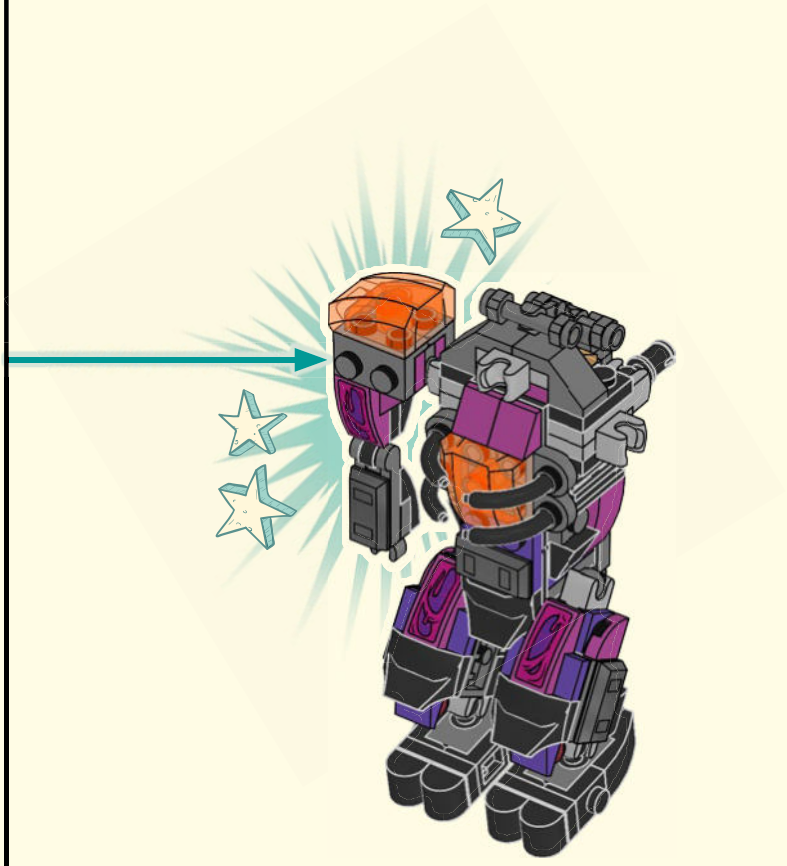

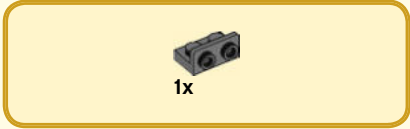

1x

74



1x

75



1x

76





77

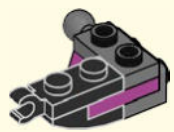

78

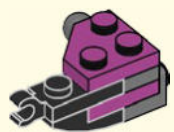

79

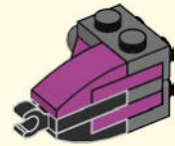

80

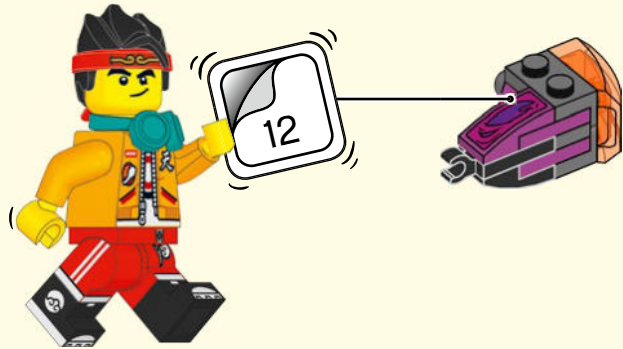

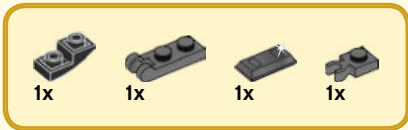

81

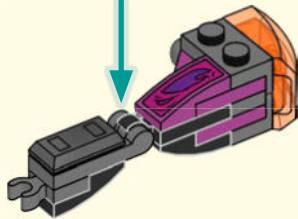
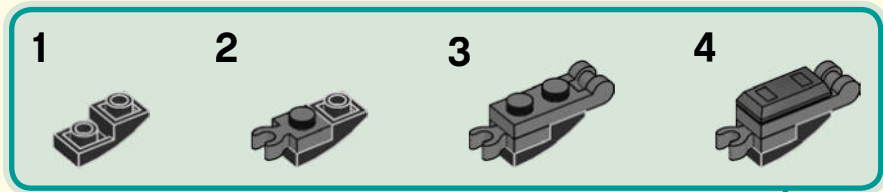

82





83



84



85

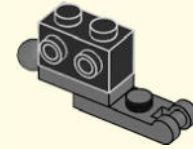

86

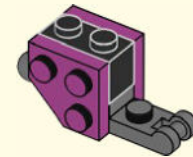



1x

87



1x

88



1x

89

1



2

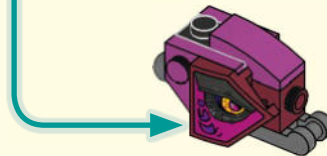

1x

90

1



2

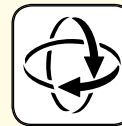

2x

1x

91

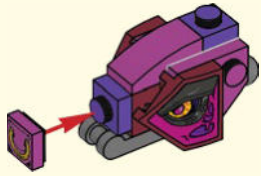

2x

2x

92

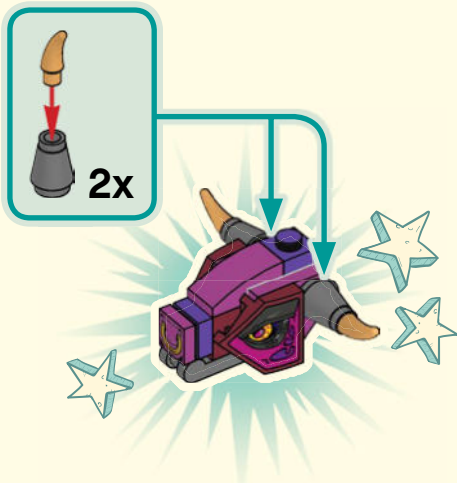

93

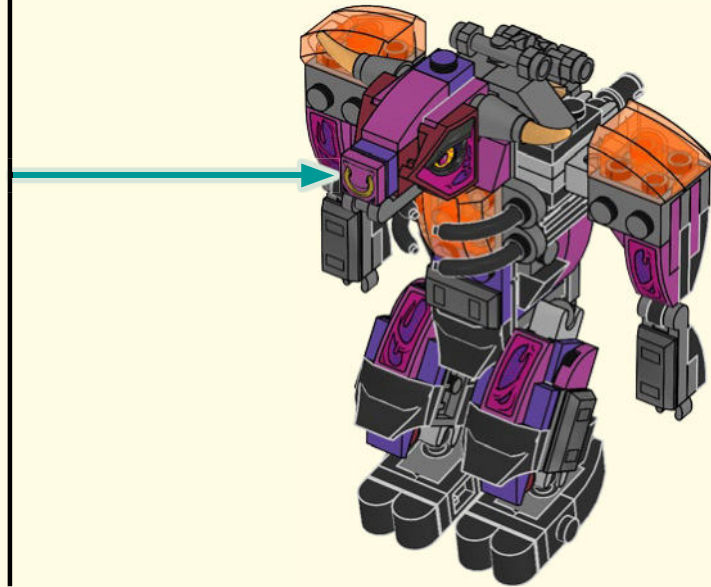



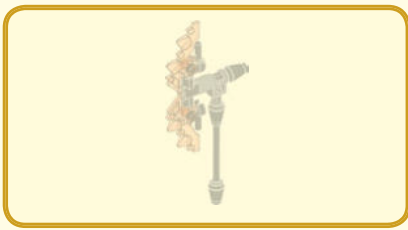

94

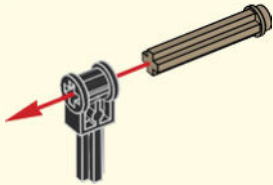

95



96

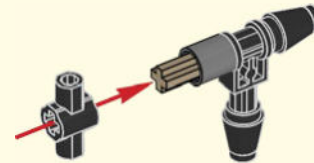

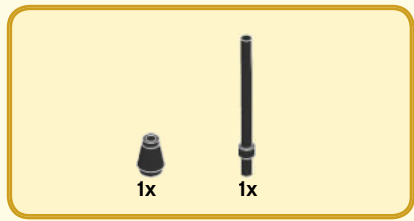

97



98

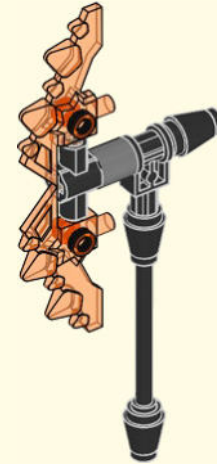



2x

99

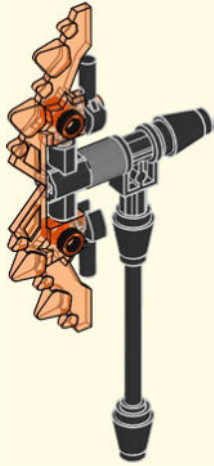

100

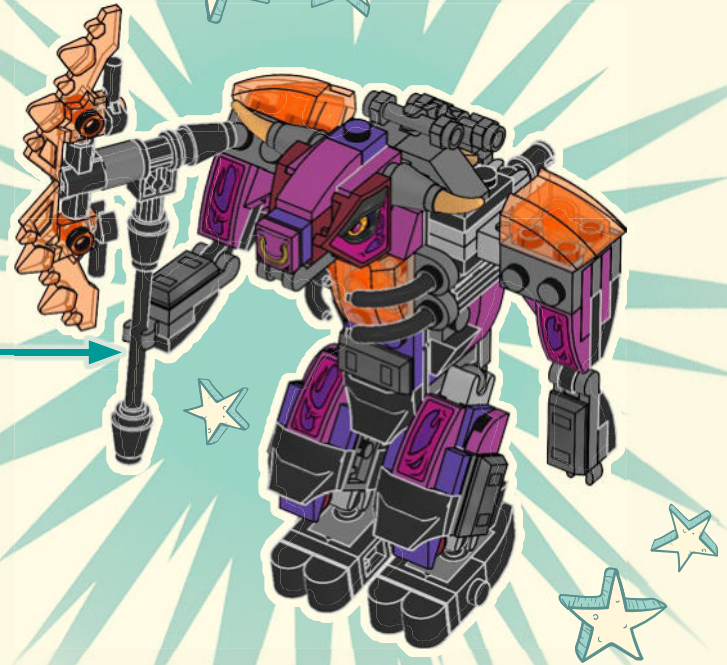

24x



287

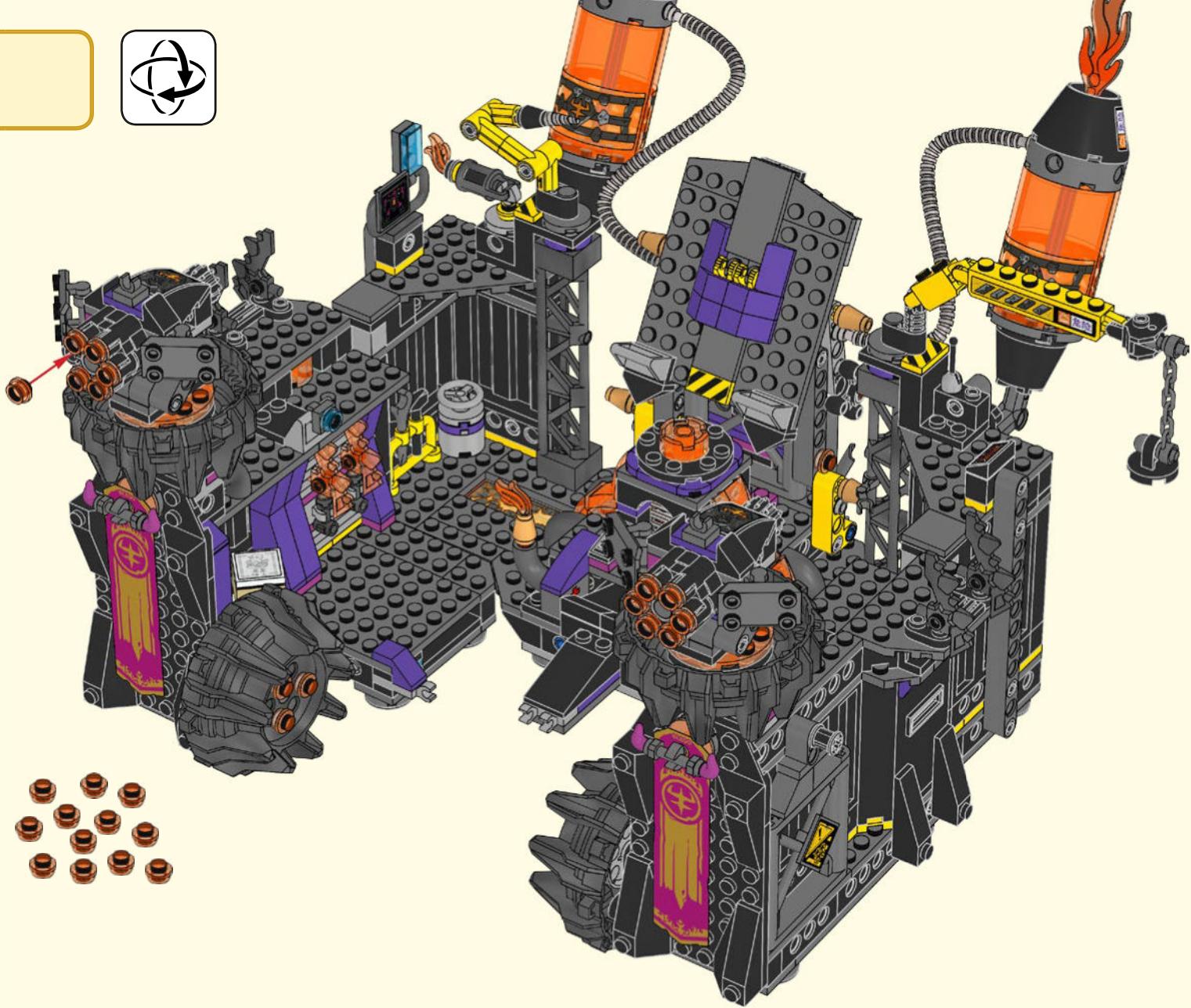

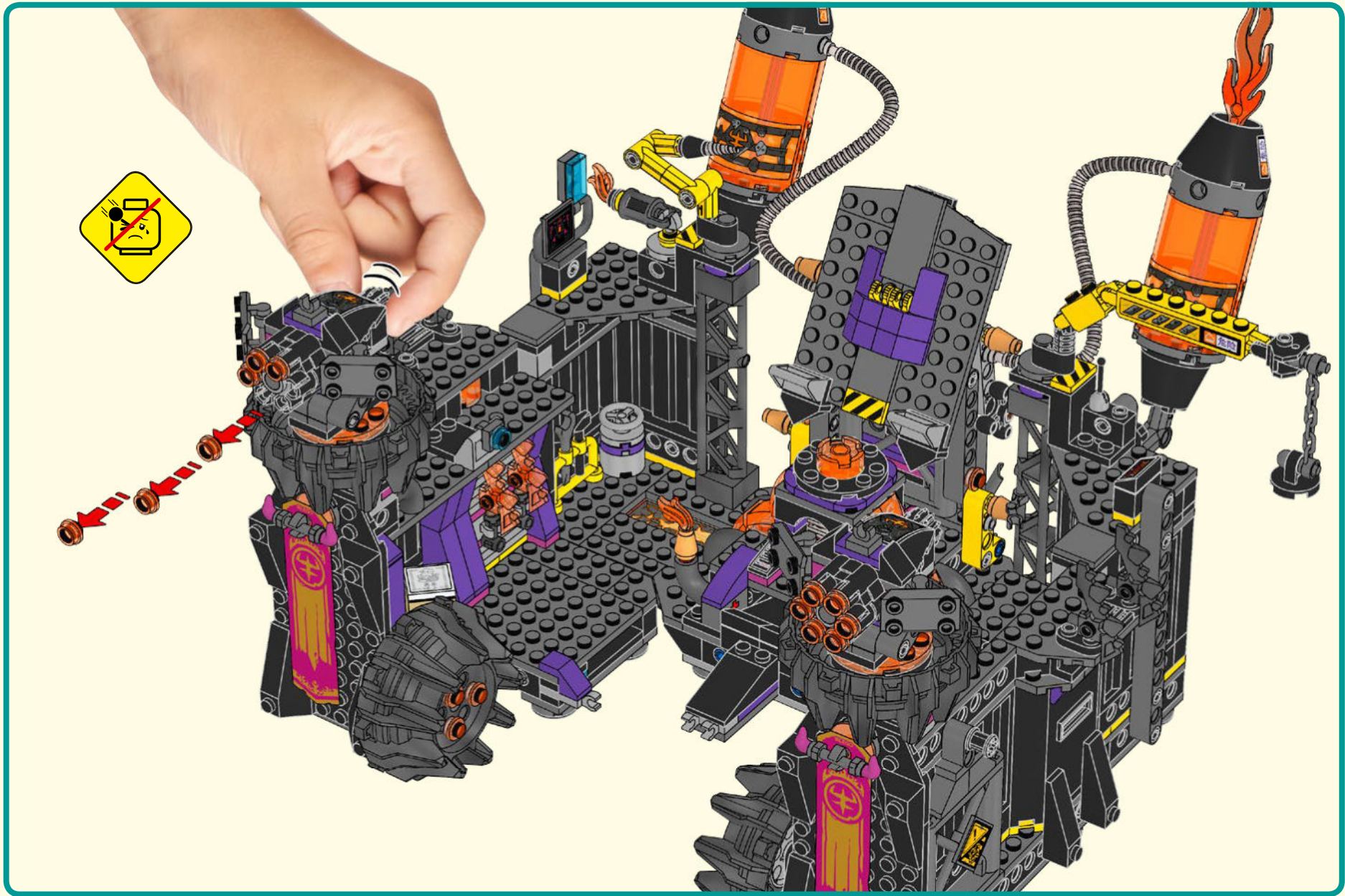

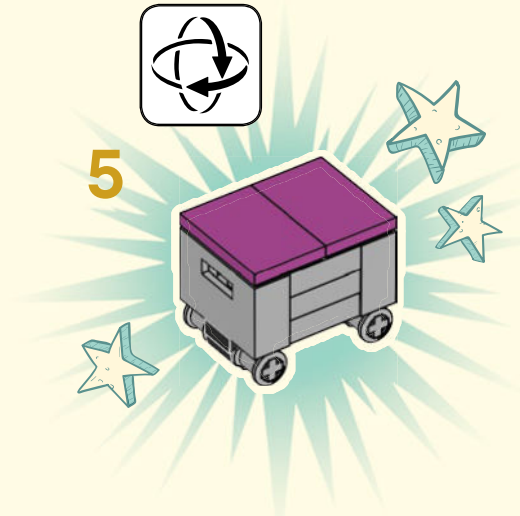
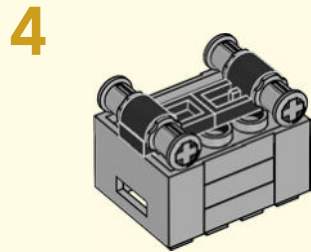
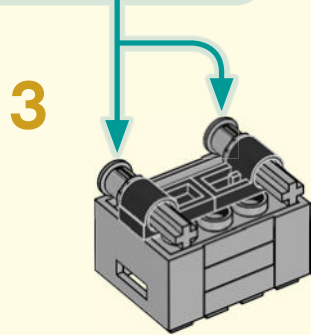
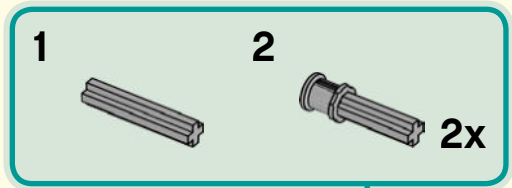
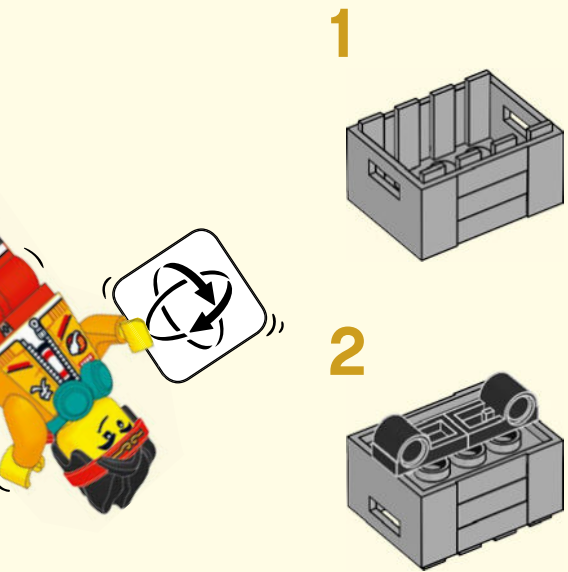
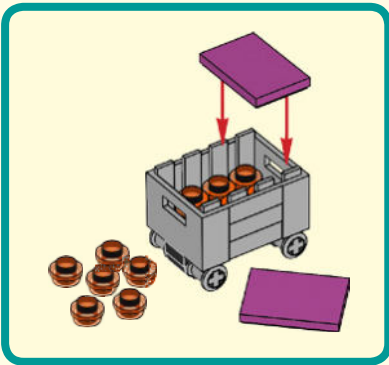
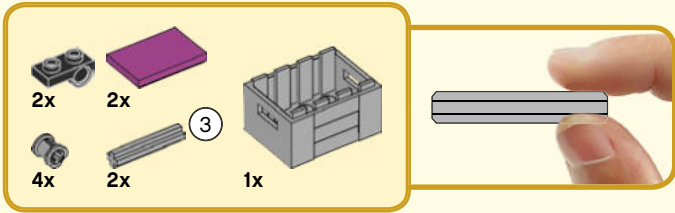

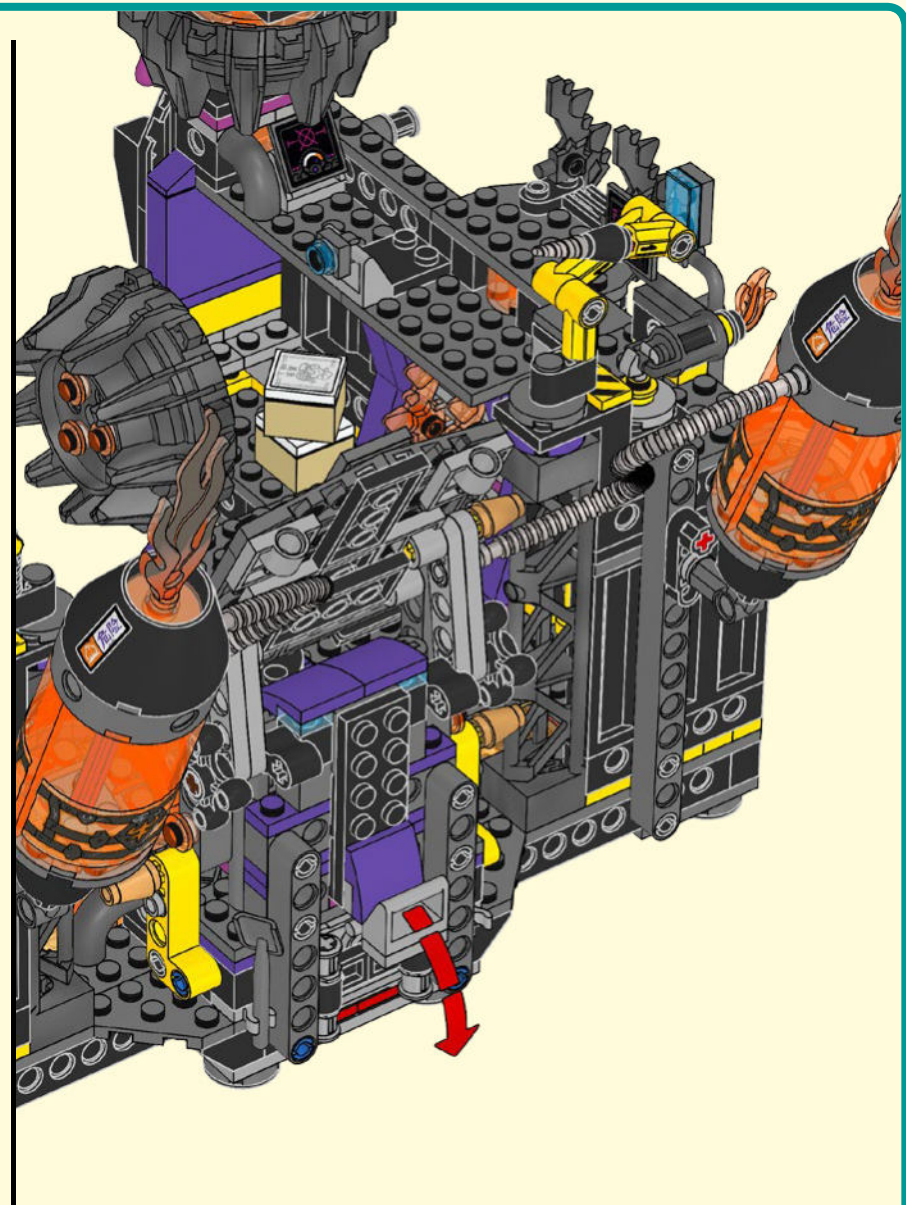
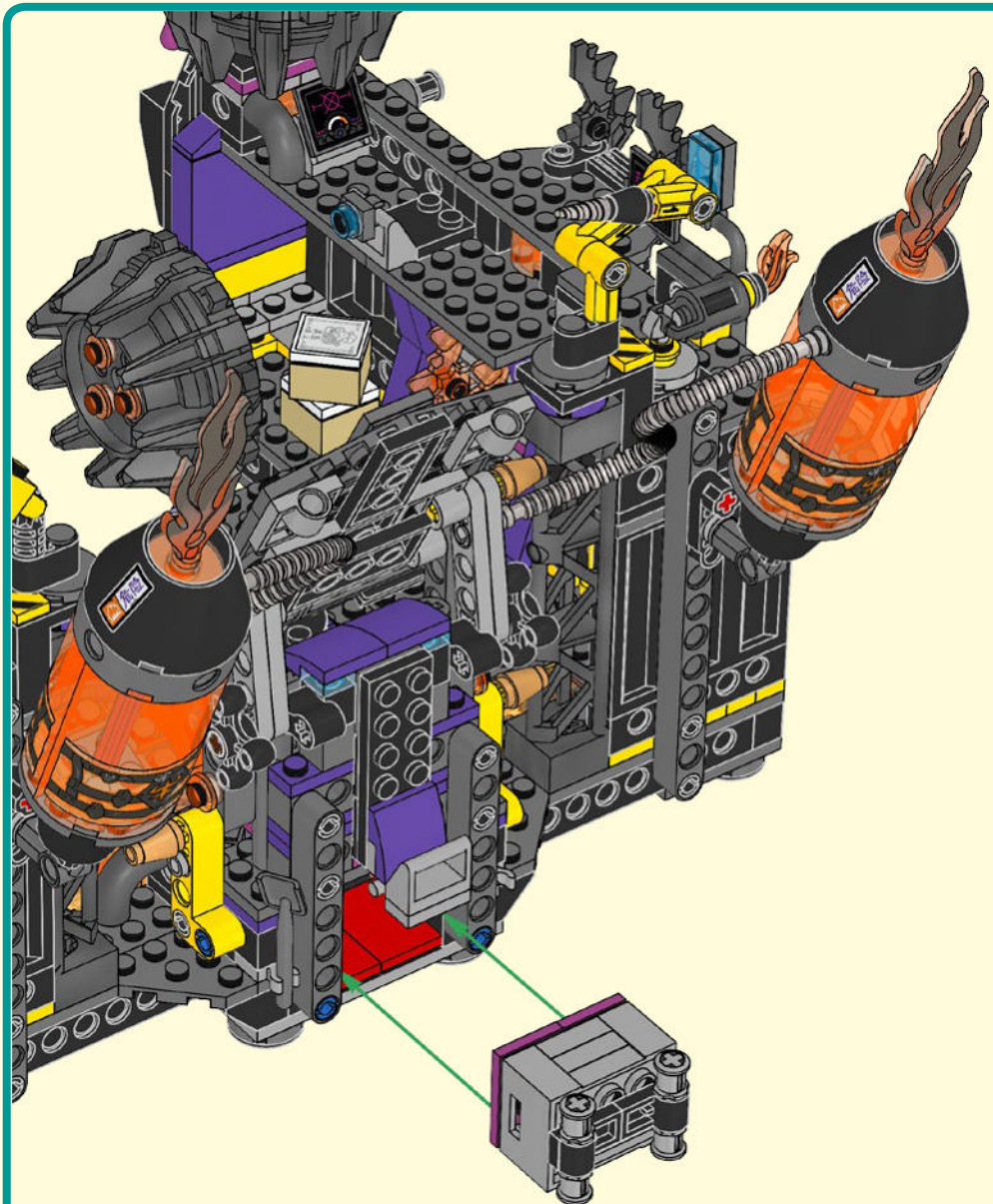

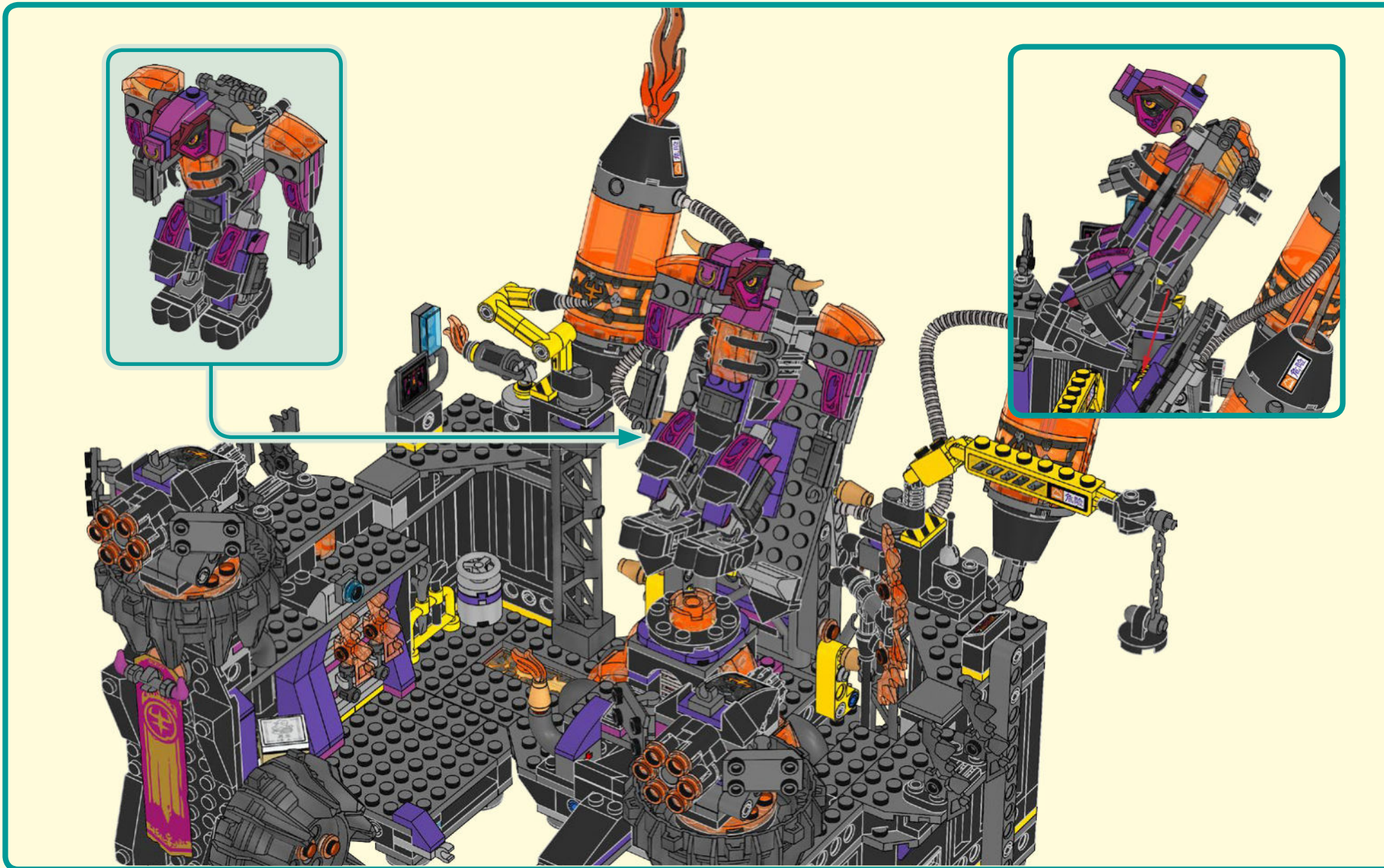



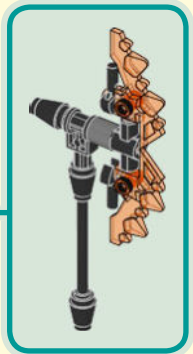
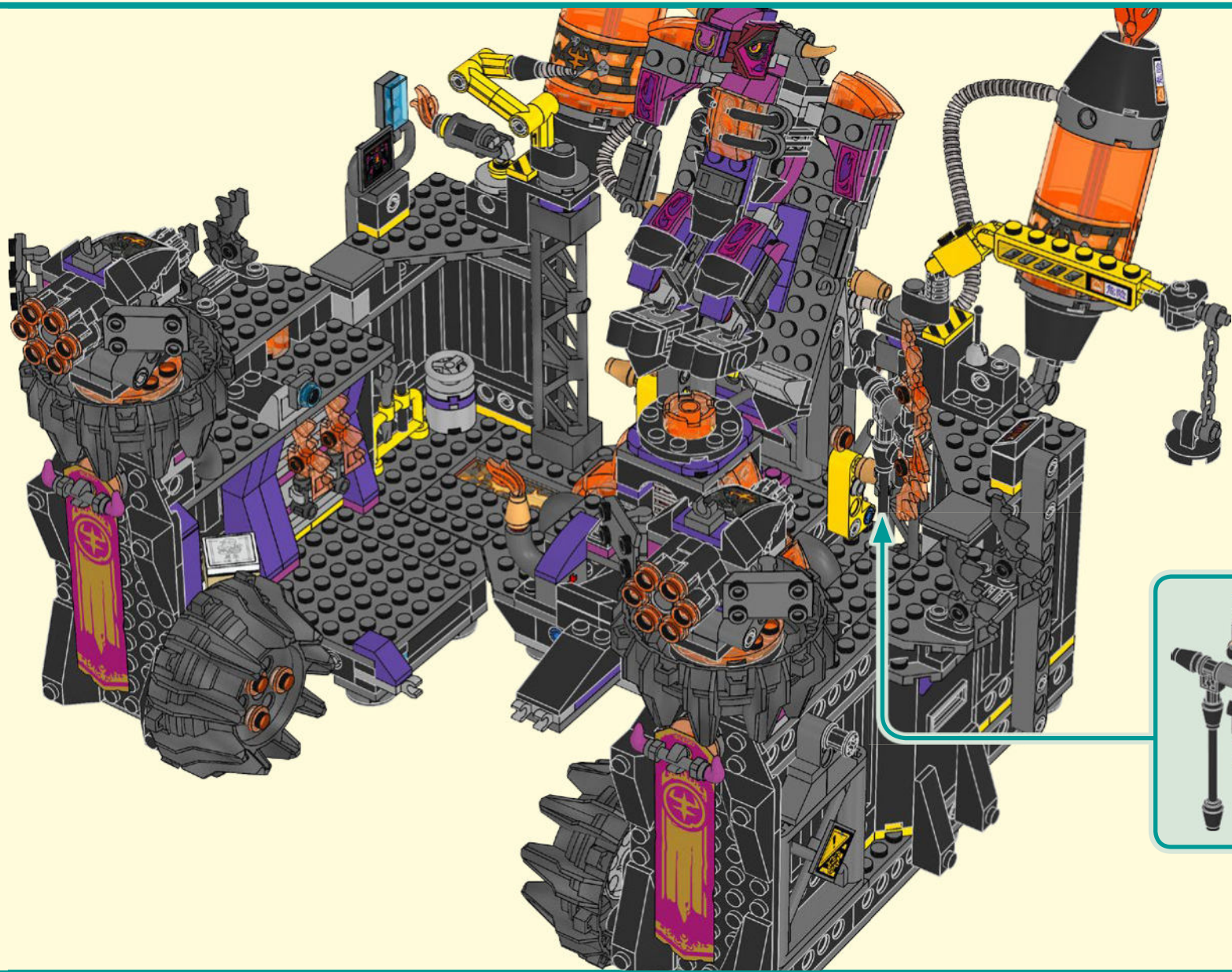

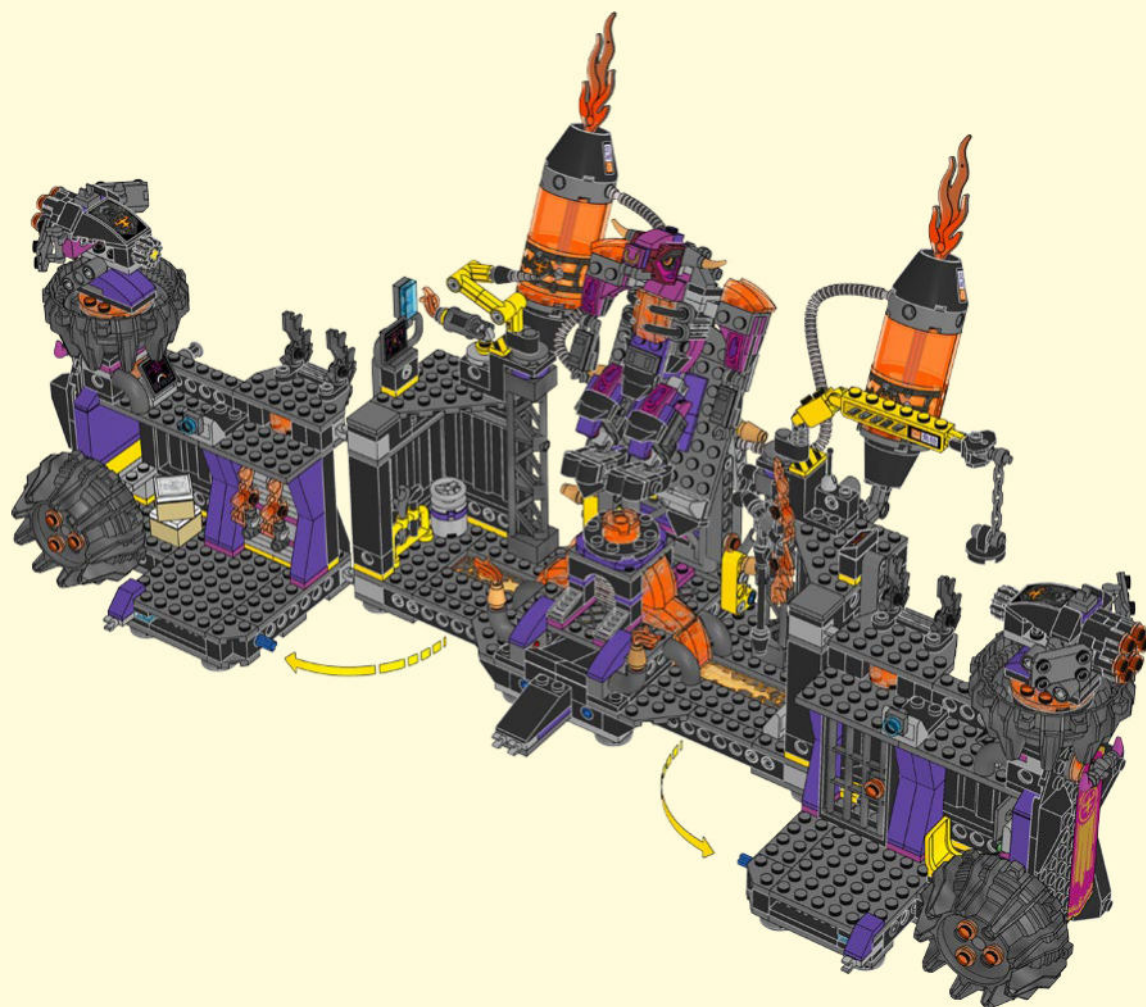

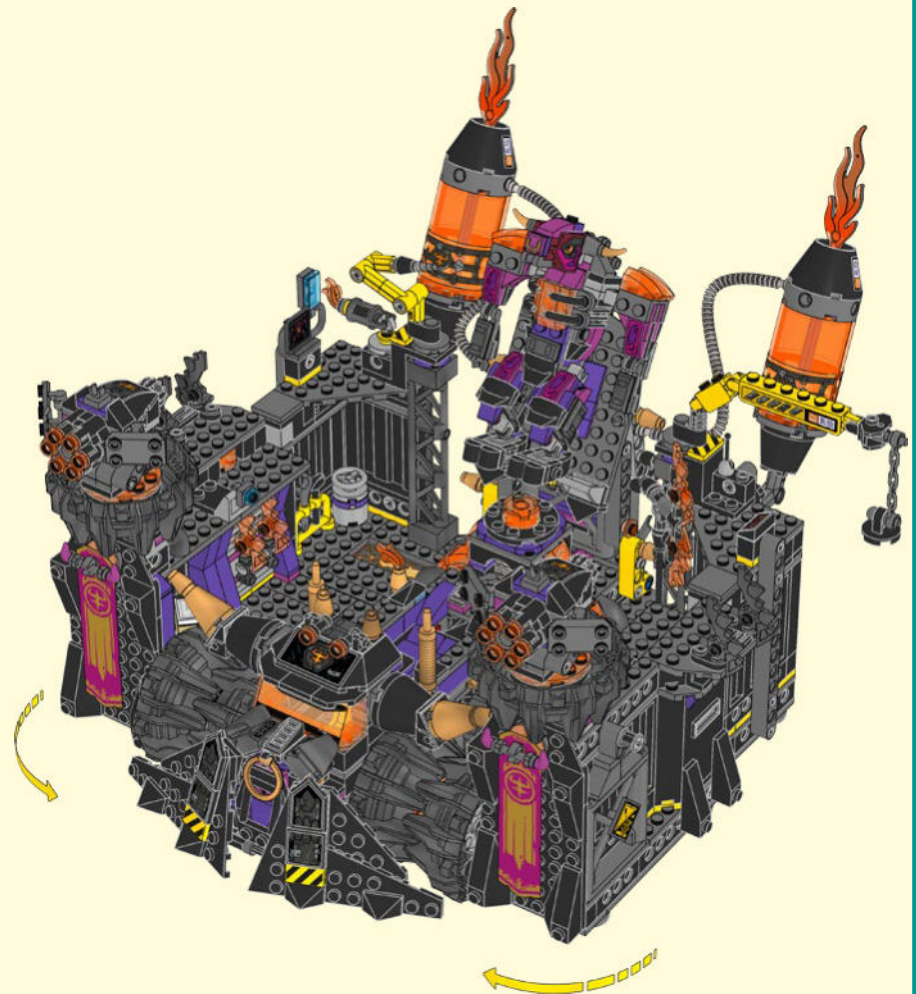
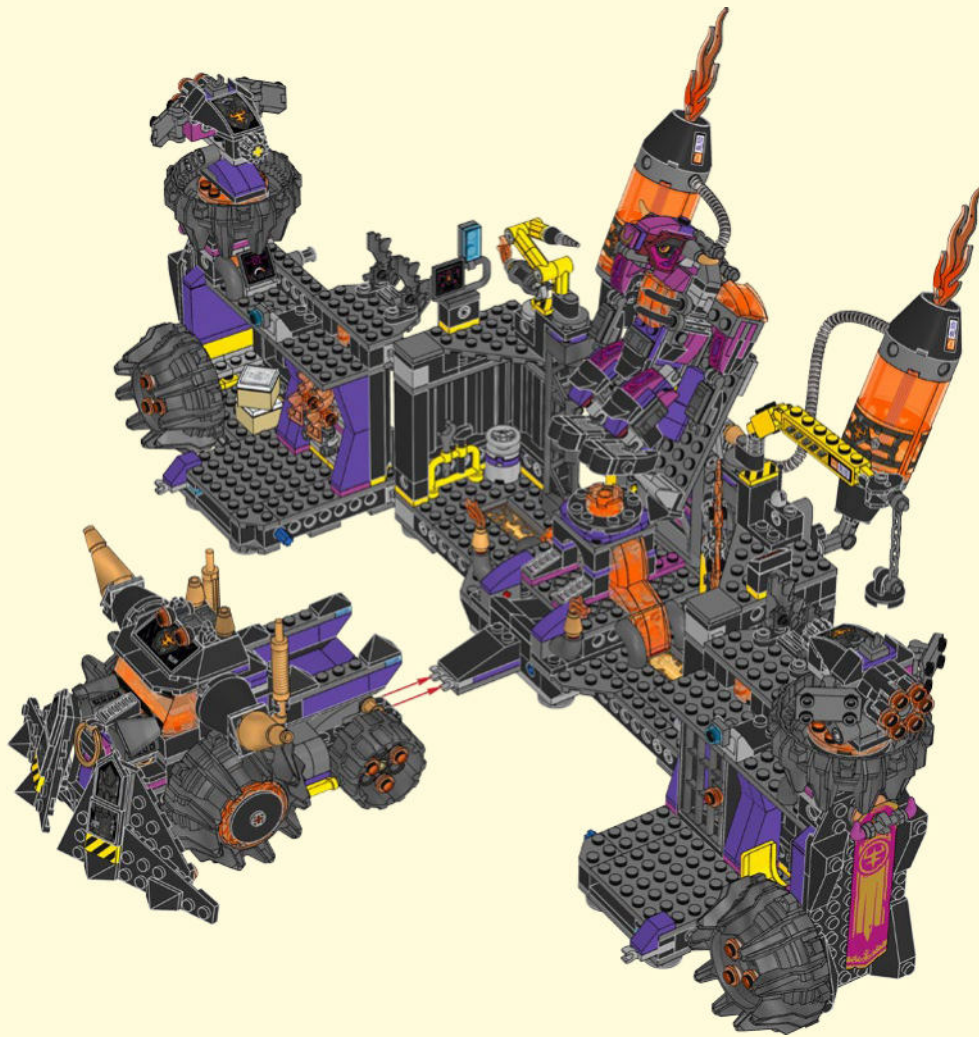

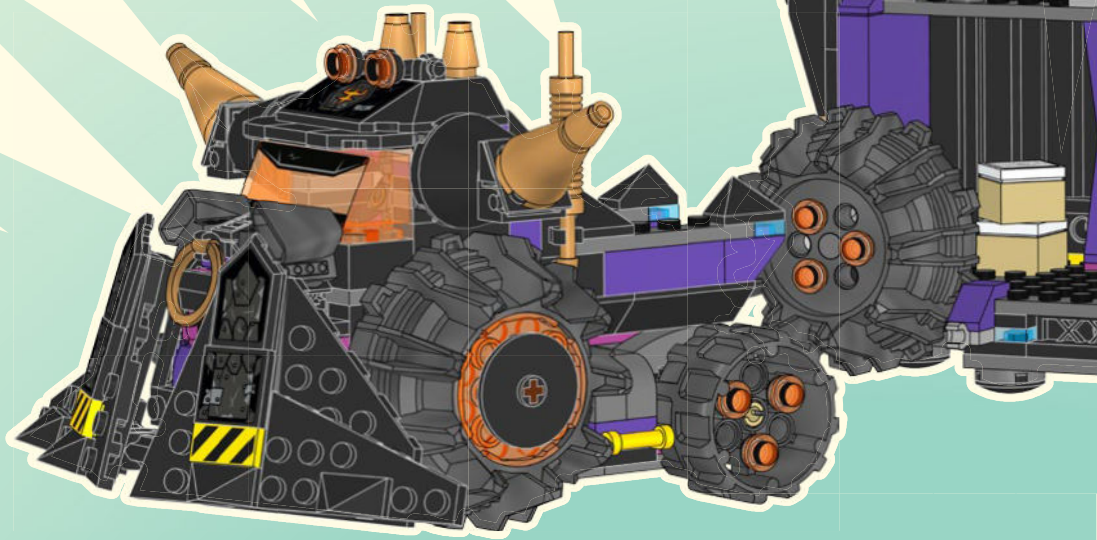
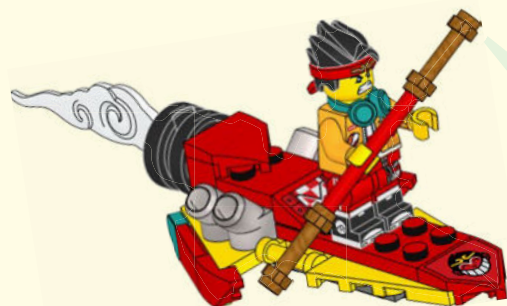



## EN

**Important information about batteries**

Never use different types of batteries together, or a combination of old and new batteries. Always remove the batteries if the product is not to be used for a long time or if the batteries have run down. Never use damaged batteries. Only use alkaline type batteries. Insert the batteries so that the poles are correctly positioned. Never attempt to recharge non-rechargeable batteries. Never short-circuit the battery holder.

## DE

**Wichtige Informationen zu Batterien**

Benutzen Sie niemals unterschiedliche Arten von Batterien oder alte und neue gleichzeitig. Nehmen Sie stets die Batterien heraus, wenn mit dem Modell längere Zeit nicht gespielt wird oder wenn die Batterien leer sind. Verwenden Sie niemals beschädigte Batterien. Verwenden Sie ausschließlich Alkali-Batterien. Achten Sie beim Einsetzen der Batterien auf die richtige Polung. Versuchen Sie unter keinen Umständen, „normale“ Batterien wieder aufzuladen. Schließen Sie das Batteriefach niemals kurz.

## FR

**Informations importantes concernant les piles**

Ne jamais utiliser un mélange de différents types de piles, ou de piles neuves et de piles anciennes ou déjà utilisées. Toujours retirer les piles si le produit n'est pas utilisé durant une période prolongée ou si les piles sont vides. Ne jamais utiliser de piles endommagées. N'utiliser que des piles alcalines. En insérant les piles, respecter scrupuleusement le sens d'orientation des pôles (+/-). Ne jamais essayer de recharger des piles non rechargeables. Ne jamais court-circuiter le compartiment des piles.

## IT

**Importanti informazioni sulle batterie**

Non usare mai contemporaneamente batterie di tipo diverso o batterie nuove e usate insieme. Rimuovere sempre le batterie qualora il prodotto non venga utilizzato per periodi prolungati, oppure se le batterie sono esauste. Non utilizzare mai batterie danneggiate. Utilizzare solo batterie di tipo alcalino. Inserire le batterie avendo cura che la loro polarità sia corretta. Non tentare mai di ricaricare batterie non ricaricabili. Non cortocircuitare mai il portabatterie.

## NL

**Belangrijke informatie over batterijen**

Gebruik nooit verschillende soorten of een combinatie van oude en nieuwe batterijen tegelijkertijd. Verwijder de batterijen altijd als je het product lange tijd niet wilt gebruiken of als batterijen leeg zijn. Gebruik nooit beschadigde batterijen. Gebruik alleen alkalinebatterijen. Plaats de batterijen met de polen in de juiste richting. Probeer nooit niet-oplaadbare batterijen opnieuw op te laden. Laat de batterijhouder nooit kortsluiten.

## ES

**Información importante acerca de las pilas**

No use pilas de diferentes tipos ni pilas nuevas y antiguas para alimentar el producto. Extraiga las pilas del producto si este va a permanecer sin uso durante un período prolongado de tiempo o aquellas se han agotado. No use pilas dañadas. Use solo pilas alcalinas. Inserte las pilas de modo que los polos queden situados en las posiciones correctas. No trate de cargar pilas no recargables. No cortocircuite el compartimento de las pilas.

## DA

**Vigtige oplysninger om batterier**

Brug aldrig forskellige batterityper sammen eller en kombination af gamle og nye batterier. Fjern altid batterierne, hvis produktet ikke skal bruges i lang tid, eller hvis batterierne er flade. Brug aldrig beskadigede batterier. Brug kun alkaliske batterier. Sæt batterierne i, så polerne vender den rigtige vej. Forsøg aldrig at oplade ikke-genopladelige batterier. Kortslut aldrig batteriholderen.

## IS

**Mikilvægar upplýsingar um rafhlöður**

Aldrei skal nota mismunandi gerðir rafhlaðna samtímis, né nýjar og eldri rafhlöður samtímis. Ef ekki á að nota tækði í lengri tíma eða ef rafhlöðurnar eru orðnar tármar skal fjarlægja rafhlöðurnar. Aldrei skal nota rafhlöður sem hafa skemmt. Tómgöngu má nota alkaline-rafhlöður. Setja skal rafhlöðurnar í þannig að plús- og mínusskaut þeirra snúi rétt. Aldrei skal reyna að endurhlaða rafhlöður sem ekki eru endurhlaðanlegar. Aldrei ætti að valda skammhlaupi í rafhlöðuhöföfnu.

## FI

**Tärkeää tietoa paristoista**

Älä koskaan käytä erityyppisiä paristoja yhdessä. Älä myöskään käytä samassa laitteessa sekä vanhoja että uusia paristoja. Poista paristot tuotteesta aina, kun se on pitemmän aikaa käyttämättä, tai kun paristot ovat tyhjentyneet. Älä koskaan käytä viallisia paristoja. Käytä vain alkaliparistoja. Aseta paristot siten, että navat osoittavat oikeaan suuntaan. Älä koskaan aiheuta oikosulkuja pariston kosketinten välillä.

## SV

**Viktig information om batterier**

Använd aldrig olika sorters batterier samtidigt, och inte heller en kombination av gamla och nya batterier. Ta alltid ur batterierna om produkten inte ska användas under en längre tid eller om batterierna är slut. Använd aldrig skadade batterier. Använd endast alkaliska batterier. Sätt i batterierna så att polerna hamnar i rätt läge. Försök aldrig ladda icke-laddningsbara batterier. Kortslut aldrig batteriutrymmets kontaktytor.

## NO

**Viktig informasjon om batterier**

Bruk aldri ulike typer batterier sammen og heller aldri gamle og nye batterier sammen. Ta alltid ut batteriene hvis produktet ikke skal brukes på lang tid, eller hvis batteriene er brukt opp. Bruk aldri skadde batterier. Bruk bare alkaliske batterier. Sett inn batteriene med polene vendt riktig vei. Forsøk aldri å lade opp ikke-oppladbare batterier. Kortslut aldri batteriholderen.

## PT

**Informação importante sobre as pilhas**

Nunca use diferentes tipos de pilhas em simultâneo, ou uma combinação de pilhas usadas e novas. Retire sempre as pilhas se o produto não for usado durante muito tempo ou se as pilhas já não tiverem carga. Nunca use pilhas danificadas. Use apenas pilhas alcalinas. Insira as pilhas de forma a que os polos fiquem corretamente posicionados. Nunca tente recarregar pilhas não recarregáveis. Nunca deixe o compartimento das pilhas entrar em curto-circuito.

## EL

**Σημαντικές πληροφορίες για τις μπαταρίες**

Μην χρησιμοποιείτε ποτέ διαφορετικούς τύπους μπαταριών μαζί και μην συνδυάζετε παλιές και καινούριες μπαταρίες. Αφαιρείτε πάντα τις μπαταρίες αν δεν σκοπεύετε να χρησιμοποιήσετε το προϊόν για αρκετό καιρό ή αν οι μπαταρίες έχουν αδειάσει. Ποτέ μην χρησιμοποιείτε μπαταρίες που έχουν φθορές. Χρησιμοποιείτε μόνο αλκαλικές μπαταρίες. Τοποθετήστε τις μπαταρίες με τους πόλους στη σωστή θέση. Μην επιχειρήσετε ποτέ να επαναφορτίσετε μη επαναφορτιζόμενες μπαταρίες. Ποτέ μην βραχυκυκλώνετε τη θήκη των μπαταριών.

## JA

**電池取扱いに関する重要事項**

異なるタイプの電池や古い電池を混ぜて使用しないでください。商品を長時間使用しないときや電池が切れたときは、電池を必ず取り外してください。不具合のある電池は絶対に使用しないでください。アルカリタイプの電池のみを使用してください。電極を確認して電池を正しい向きに入れてください。充電式ではない電池は絶対に充電しないでください。電池ホルダをショートさせないでください。

## ZH

**電池使用注意事项**

请勿同时使用不同类型的电池，或把新旧程度不同的电池混合使用。如果产品将有很长时间不会使用，或者电池已经没电，请注意取出电池。切勿使用已破损的电池。仅可使用碱性电池。装入电池时请注意正负极。请勿尝试给非充电电池充电。切勿对电池仓进行短路连接。

## KO

**배터리 사용 시 주의사항**

다른 종류의 배터리를 함께 사용하거나, 새 전지와 오래된 전지를 혼용하지 마세요. 배터리가 방전되었거나 장기간 제품을 작동하지 않을 때에는 반드시 배터리를 분리하세요. 파손된 배터리는 사용하지 마세요. 알칼라인 타입의 배터리를 사용하세요. 양극과 음극의 위치를 잘 맞춰서 넣으세요. 일반 배터리는 충전해서 사용할 수 없습니다. 배터리 홀더의 접촉부에 배터리를 정확히 끼워서 사용하세요.

## RU

**Необходимая информация об элементах питания**

Ни в коем случае не используйте одновременно элементы питания различных типов, а также элементы питания с разным сроком годности. В обязательном порядке вынимайте элементы питания из терминалов в случае, если вы не пользуетесь прибором в течение долгого времени, либо в случае, если в элементах питания закончился заряд. Ни в коем случае не используйте поврежденные элементы питания. Используйте только элементы питания щелочного типа. Установите элементы питания, соблюдая указанную полярность. Ни в коем случае не пытайтесь подзарядить перезаряжаемые элементы питания. Ни в коем случае не пытайтесь замкнуть полюса в устройстве для элементов питания.

## PL

**Ważne informacje dotyczące baterii**

Nigdy nie należy stosować razem różnych rodzajów baterii ani stosować równocześnie starych i nowych baterii. Jeżeli produkt nie jest używany przez dłuższy czas lub jeżeli baterie się wyczerpały, należy wyjąć baterie. Nigdy nie należy stosować uszkodzonych baterii. Należy używać wyłącznie baterii alkalicznych. Przy wkładaniu baterii należy zwrócić uwagę na właściwe położenie biegunów. Nigdy nie należy próbować ładowania baterii jednorazowych. Nigdy nie należy doprowadzać do zwarcia w gnieździe baterii.

## CZ

**Důležitá informace o bateriích**

Nikdy nepoužívejte najednou různé typy baterií nebo kombinaci starých a nových baterií. Nebude-li se výrobek delší dobu používat nebo jsou-li baterie vybité, vždy je vyjměte z výrobku. Nikdy nepoužívejte poškozené baterie. Používejte pouze alkalické baterie. Baterie instalujte se správnou orientací pólů. Nikdy se nesnažte nabíjet baterie, které nejsou nabíjitelné. Nikdy nezkratujte kontakty v prostoru pro baterie.

## SK

**Dôležitá informácia o batériách**

Nikdy nepoužívajte naraz odlišné typy batérií ani nekombinujte staré batérie s novými. Batérie vždy vyberte, ak sa výrobok nebude dlhšie používať, alebo ak sa batérie vybité. Nikdy nepoužívajte poškodené batérie. Používajte iba alkalické batérie. Batérie vkladajte so správnou orientáciou pólou. Nikdy sa nesnažte nabíjať batérie, ktoré nie sú nabíjateľné. Nikdy neskratuje kontakty v priestore pre batérie.

## HU

**Fontos tudnivalók az elemekről**

Soha ne használjon különböző típusú elemeket, illetve ne használjon vegyesen új és használt elemeket. Mindig távolítsa el az elemeket, ha a készülékét előre láthatóan hosszabb ideig nem fogják használni, vagy ha az elemek lemerültek. Soha ne használjon megrongálódott elemeket. Csak alkáli elemeket használjon! Az elemeket helyesen helyezze be, a polarításuknak megfelelően. Soha ne próbálja meg feltölteni a nem tölthető elemeket. Soha ne hozzon létre rövidzárlatot az elemtartó kivezetésin.

## UA

### Необхідна інформація про батареї

Ніколи не використовуйте одночасно батареї різних типів або батареї з різним терміном придатності. Обов'язково вилучайте батареї з приладу, якщо довго не користуетесь ним, або якщо в батареях уже скінчився заряд. Ніколи не використовуйте пошкоджені батареї. Використовуйте лише лужні батареї. Вставляйте батареї, враховуючи задану полярність. У будь-якому випадку не намагайтеся підзарядити батареї, що не підлягають підзарядці. У будь-якому випадку не намагайтеся зробити коротке замикання в приладі для батарей.

## HR

### Važne obavijesti o bateriji

Nikada nemoj koristiti različite vrste baterija zajedno, isto tako ni kombinaciju starih i novih baterija. Uvijek izvadi baterije ako dugo nećeš koristiti proizvod ili ako su one potrošene. Nikada nemoj koristiti oštećene baterije. Upotrebljavajte samo alkalne baterije. Umetni baterije pažeci da dobro okreneš polove. Nikada ne pokušavaj puniti baterije koje nisu predviđene za punjenje. Nikada ne izazivaj kratki spoj u držaču baterija.

## SR

### Vажне информације о батеријама

Никада не користите различите типове батерија заједно нити комбинацију старих и нових батерија. Увек извадите батерије уколико производ нећете дуже време користити или уколико су батерије празне. Никада не користите оштећене батерије. Користите само алкалне батерије. Ставите батерије тако да су полови правилно позиционирани. Никада не покушавајте да пуните батерије које не могу да се пуне. Никада не изазивајте кратак spoj у кућишту за батерије.

## MK

### Важни информации за батериите

Никогаш не користете различни типови батерији заедно или комбинација од стари и нови батерији. Секогаш отстранувајте ги батериите доколку не го користите производот подолго време или доколку се потрошиле. Никогаш не користете оштетени батерији. Користете само алкални батерији. Вметнете ги батериите така што точно ќе ги наместите половите. Никогаш не обидувајте се да ги полните батериите за еднократна употреба. Никогаш не предизвикувајте краток spoj на држачот за батерији.

## SL

### Pomembne informacije o baterijah

Nikoli ne uporabljajte skupaj različnih baterij ali kombinacije starih in novih baterij. Vedno odstranite baterije, če izdelka dlje časa ne boste uporabljali ali če so iztrošene. Nikoli ne uporabljajte poškodovanih baterij. Uporabljajte le alkalne baterije. Baterije vstavite tako, da so njihovi polji pravilno obrnjeni. Nikoli ne poskušajte polniti baterij, ki niso akumulatorske. Pazite, da ležišč za baterije ne boste spravili v kratek stik.

## RO

### Informații importante despre baterii

Nu folosiți niciodată împreună tipuri diferite de baterii, sau o combinație de baterii vechi și noi. Îndepărtați întotdeauna bateriile dacă produsul nu este folosit timp îndelungat sau dacă bateriile s-au epuizat. Nu folosiți niciodată baterii deteriorate. Utilizați numai baterii de tip alcalin. Introduceți bateriile astfel ca poliți să fie poziționați corect. Nu încercați niciodată să reîncărcați baterii nereîncărcabile. Nu scurcircuitați niciodată suportul bateriei.

## BG

### Важна информация за батериите

Никога не използвайте едновременно различни типове батерији или комбинация от стари и нови батерији. Винаги изваждайте батериите, ако изделите няма да се използва продължително време или ако батериите са се изтозили. Никога не използвайте повредени батерији. Използвайте само алкални батерији. Поставете батериите така, че полюсите да са разположени правилно. Никога не опитвайте да зареждате батерији, които не са акумулаторни. Никога не свързвайте на късо контактите на отделението за батериите.

## LV

### Svarīga informācija par baterijām

Nekad vienlaikus nelietojiet dažādu tipu, kā arī vecas un jaunas baterijas. Vienmēr izņemiet baterijas, ja tās ir izlādējušas vai ja produkts ilgāku laiku netiek lietots. Nekad nelietojiet bojātas baterijas. Izmantojiet tikai sārma tipa baterijas. Ievietojot baterijas, ievērojiet pareizu polaritāti. Nekad nemēģiniet uzlādēt baterijas, kas nav uzlādējamas. Nepieļaujiet īssavienojumu bateriju nodalījumā.

## ET

### Oluline teave patareide kohta

Ära kunagi kasuta koos erinevat tüüpi patareisid, samuti vanu ja uusi patareisid. Kui märguasia ei kasutata pika aja jooksul, võta patarei sellest välja. Ära kunagi kasuta kahjustatud patareisid. Kasuta ainult leelis-patareisid. Pane patareid märguasia sisse nii, et pluss- ja miinusklemmi asend oleks õige. Ära kunagi proovi akulaadijaga laadida tavalisi patareisid. Patareipesa klemmide vahel ei tohi tekkida lühis.

## LT

### Svarbi informacija apie elementus

Vienu metu nenaudokite skirtingų elementų, taip pat su naujais elementais nenaudokite senų. Jei nenaudosite gaminio ilgesnį laiką arba jei elementai išseko, visuomet išimkite juos iš gaminio. Niekada nenaudokite pažeistų elementų. Naudokite tik šarminius elementus. Elementus dėkite atsižvelgdami į jų poliškumą. Niekada nebandykite įkrauti vienkartinį elementų. Saugokitės, kad elementų įdėkle nesukeltumėte trumpojo jungimo.

## TR

### Piller hakkında önemli bilgiler

Hiçbir zaman farklı tipte pilleri ya da eski pillerle yeni pilleri bir arada kullanmayın. Ürün uzun süre kullanılmayacaksa ya da piller bitmişse, pilleri ürünü içinden çıkarın. Hiçbir zaman zedelenmiş piller kullanmayın. Sadece alkalın piller kullanın. Pilleri kutuları doğru konumda olacak şekilde yerleştirin. Hiçbir zaman, şarj edilebilir olmayan pilleri şarj etmeye çalışmayın. Hiçbir zaman pil kutusunda kısa devre yaptırmayın.

## AR

### معلومات مهمة عن البطاريات

يحظر استخدام أنواع مختلفة من البطاريات معاً أو مزيج من البطاريات القديمة والجديدة. احرص دائماً على نزع البطاريات في حال عدم استخدام المنتج لفترة طويلة أو إذا نفذت طاقة البطاريات. تجنب استخدام البطاريات التالفة. لا تستخدم إلا البطاريات القلوية فقط. قم بتكريب البطاريات بحيث تكون الأقطاب في موضعها الصحيح. يحظر إعادة شحن البطاريات غير القابلة لإعادة الشحن. تجنب إحداث دائرة قصر في حامل البطارية.

## ID

### Informasi penting tentang baterai

Jangan gunakan baterai yang jenisnya berlainan, atau mencampur baterai lama dan baterai baru. Lepas baterai jika produk tidak akan digunakan untuk waktu lama atau jika baterai sudah lemah. Jangan gunakan baterai yang rusak. Gunakan hanya baterai alkali. Masukkan baterai dengan posisi kutub yang tepat. Jangan pernah coba mengisi ulang baterai biasa. Jangan pernah membuat arus pendek pada dudukan baterai.

## MS

### Maklumat penting tentang bateri

Jangan guna jenis bateri yang berbeza bersama-sama, atau gabungan bateri baharu dan lama. Tanggalkan bateri jika produk tidak akan digunakan untuk tempoh masa yang lama atau jika bateri telah kehabisan kuasa. Jangan guna bateri yang rosak. Guna bateri jenis alkali sahaja. Selitkan bateri supaya paksi berada pada kedudukan yang betul. Jangan cuba untuk mengecap semula bateri yang tidak boleh dicaskan semula. Jangan pintas litar pemegang bateri.

EN Please retain the leaflet as it contains important information  
DE Die Broschüre bitte aufbewahren, sie enthält wichtige Informationen  
FR Veuillez conserver le dépliant car il contient des informations importantes  
IT Conserva l'opuscolo in quanto contiene informazioni importanti  
NL Bewaar a.u.b. de folder: die bevat belangrijke informatie  
ES Conserve el folleto; contiene información importante  
DA Gem hæftet, da det indeholder vigtige oplysninger  
IS Geymið þækinginn þar sem hann inniheldur mikilvægar upplýsingar  
FI Säilytä esite, koska se sisältää tärkeää tietoa  
SV Spara broschyren eftersom den innehåller viktig information  
NO Heftef inneholder viktig informasjon og skal beholdes  
PT Por favor guarde o folheto, pois contém informação importante  
EL Κρατήστε το φυλλάδιο γιατί περιέχει σημαντικές πληροφορίες  
JA 説明書には重要な情報が含まれていますので保管しておいてください  
ZH 本说明书包含重要信息，请务必妥善保存  
KO 중요한 정보가 담겨있으므로 리플릿을 보관해두세요  
RU Пожалуйста, сохраните упаковку, поскольку она содержит важную информацию  
PL Prosimy zachować ulotkę, ponieważ zawiera ona ważne informacje  
CZ Ponechte si prosím leták, neboť obsahuje důležité informace  
SK Ponechajte si prosím leták, pretože obsahuje dôležité informácie  
HU Kérjük, őrizze meg a szórólapot, mert fontos tudnivalókat tartalmaz  
UA Будь ласка, зберігайте упаковку, оскільки вона містить важливу інформацію  
HR Spremite letak jer sadrži važne obavijesti  
SR Молимо да сачувате унутство јер се у њему налазе важне информације  
MK Чувајте ја брошурата бидејќи содржи важни информации  
SL Prosimo, da brošurico shranite, saj so v njej pomembne informacije  
RO Vă rugăm să păstrați broșura întrucât contine informații importante  
BG Запазете листовката, тъй като вътре има ценна информация  
LV Lūdzu, saglabājiet bukletu, jo uz tā ir norādīta svarīga informācija  
ET Hoidke infoleht alles, sest sellele on märgitud oluline teave  
LT Išsaugokite informacinį lapelį, nes ant jos pateikiama svarbi informacija  
TR Önemli bilgiler içerdiğinden dolayı lütfen broşürü saklayın  
AR الرجاء الاحتفاظ بهذه النشرة لاحتوائها على معلومات هامة  
ID Harap simpan lembaran ini karena berisi informasi penting  
MS Sila simpan lembar maklumat kerana ia mengandungi maklumat penting

LEGO System A/S  
Aastvej 1  
DK-7190 Billund



EN

Protect the environment by not disposing of this product with your household waste.  
Check with your local authority for recycling advice and facilities.

DE

Schützen Sie die Umwelt und entsorgen Sie dieses Produkt nicht mit Ihrem Hausmüll.  
Informationen zu Recycling-Möglichkeiten erhalten Sie bei den örtlichen Behörden.

FR

Protégez l'environnement : ne jetez pas ce produit avec vos autres déchets ménagers.  
Contactez les autorités locales pour obtenir des informations sur le recyclage et connaître les points de collecte.

IT

Proteggj l'ambiente! Non smaltire questo prodotto con i rifiuti domestici.  
Per consulenza sul riciclaggio dei rifiuti e le strutture di riciclaggio, rivolgersi alle proprie autorità locali.

NL

Bescherm het milieu: gooi dit product niet samen met het andere huisvuil weg.  
Raadpleeg de plaatselijke instanties voor locaties van milieustations en advies over hergebruik.

ES

Proteja el medio ambiente no deshaciéndose de este producto junto con sus residuos domésticos.  
Solicite asesoramiento e información sobre instalaciones de reciclaje a las autoridades locales.

DA

Beskyt miljøet! Smid ikke dette produkt ud sammen med husholdningsaffaldet.  
Få vejledning om genbrug og genbrugsstationer hos din kommune.

IS

Stuðlið að umhverfisvernd með því að farga þessari vöru ekki með heimilissorpi.  
Leitið upplýsinga um endurvinnslu- og förgunarstaði hjá yfirvöldum á hverjum stað.

FI

Tämä tuote on hävitettävä ympäristöstävällisesti ja erillään muusta talousjätteestä.  
Tietoja kierrätyksestä ja keräyspisteiden sijainnista saat paikkakuntasi teknisestä virastosta.

SV

Skydda miljön genom att inte kasta denna produkt bland ditt hushållsavfall.  
Kontakta din kommun för frågor om återvinning och miljöstationer.

NO

Beskytt miljøet. Ikke kast dette produktet i husholdningsavfallet.  
Kontakt kommunen for veiledning om gjenbruk og miljøstasjoner.

PT

Proteja o ambiente não eliminando este produto com o seu lixo doméstico.  
Consulte as autoridades locais para informação sobre reciclagem e sistemas de recolha.

EL

Προστατέψτε το περιβάλλον. Μην πετάτε αυτό το προϊόν μαζί με τα συνηθισμένα οικιακά απορρίμματα.  
Επικοινωνήστε με τις τοπικές αρχές σχετικά με συμβουλές και εγκαταστάσεις ανακύκλωσης.

JA

環境保護のため、本製品は家庭ごみとは別に処分してください。  
リサイクルに関する指示や施設については、お住まいの地方自治体にお問い合わせください。

ZH

注意保护环境，请勿将本产品与生活垃圾一起丢弃处理。  
请咨询当地相关部门，了解与回收相关的设施与建议。

KO

환경 보호를 위해 이 제품을 생활폐기물과 함께 버리지 마십시오.  
재활용 방법 및 시설에 관한 사항은 현지 관계 당국에 문의하십시오.

RU

Позаботьтесь об окружающей среде: не утилизируйте этот продукт вместе с бытовым мусором.  
Узнайте в органах местного самоуправления правила вторичной переработки и утилизации таких отходов.

PL

Aby chronić środowisko naturalne, nie należy wyrzucać tego produktu wraz z odpadkami z gospodarstwa domowego.  
W celu uzyskania wskazówek dotyczących recyklingu oraz adresów zakładów należy skontaktować się z lokalnym urzędem.

CZ

Nevyhazujte tento produkt do domácího odpadu, chraňte životní prostředí.  
Zjistěte si prosím u místních úřadů možnosti recyklace a dostupná zařízení.

SK

Nevyhadzujte tento produkt do domáceho odpadu, chráňte životné prostredie.  
Zistite si na miestnych úradoch možnosti recyklácie a dostupné zariadenia.

HU

Környezetét óvja, ha ettől a terméktől nem a háztartási hulladékkal együtt válik meg.  
Érdeklődjék a lakóhelyéhez közel eső hatóságnál az újrahasznosítás módjáról és lehetőségeiről.

UA

Допоможіть захистити довкілля: не утилізуйте цей виріб разом із побутовим сміттям.  
Вказівки з утилізації та відомості про пункти прийому з'ясуєте в місцевих компетентних органах.

HR

Zaštite okoliš tako da ovaj proizvod ne odložite u otpad zajedno s kućanskim otpadom.  
Od lokalnih vlasti zatražite savjet ili informacije o pogonima za recikliranje.

SR

Zaštite životnu sredinu tako što nećete da odlažete ovaj proizvod sa kućnim otpadom.  
Raspitajte se kod lokalnog nadležnog organa o načinu reciklaže i o sabirnom centru.

MK

Zaštite je okolinata tako što nema da se oslobodite od proizvoda od domaćeg otpada.  
Konzultirajte se sa lokalnim vlastima za da doznate za savete i objekte za recikliranje.

SL

Zaščitite okolje! Okolje varujte tako, da tega izdelka ne zavržete skupaj z gospodinskimi odpadki.  
Pri krajevni upravi preverite, kakšne možnosti in kateri obrati za recikliranje obstajajo v vaši okolici.

RO

Protejați mediul înconjurător și nu vă debarasați de acest produs împreună cu deșeurile menajere  
Consultați autoritățile locale pentru îndrumări și facilități de reciclare.

BG

Zaštite okolinata sreda i ne izhvǎrlyajte tozi produkt zaedno s bitovite si otpadǎtzi.  
Svǎrжете се с местните власти относно съвети и съоръжения за рециклиране.

LV

Lai saudzētu vidi, neizmetiet šo izstrādājumu kopā ar sadzīves atkritumiem.  
Vērsieties vietējās varas iestādēs, lai noskaidrotu, kur un kā tas nododams pārstrādei.

ET

Keskkonda saate kaitsta nii, et ei kõrvalda seda toodet koos olmejäätmetega.  
Nõuandeid toote taaskasutusse võtmise ja ümbertöötlemispunktide kohta saate asjaomaset kohalikult asutuselt.

LT

Saugokite aplinką: nemeskite šio produkto kartu su buitinėmis atliekomis.  
Atsižvelkite į savo vietos valdžios rekomendacijas dėl pakartotinio panaudojimo ir sąlygas.

TR

Bu ürünü, evsel atıklarla birlikte atmayarak çevreyi koruyun.  
Gerİ dönüŖüm tavsiyeleri ve tesisler hakkında bilgi için yerel yönetimle iletişim kurun.

AR

احم البيئة بعدم التخلص من هذا المنتج مع الخلفات المنزلية.  
استشر السلطة المحلية لديك للحصول على نصح بخصوص إعادة تدوير الخلفات ومرافقها.

ID

Jagalah lingkungan dengan tidak membuang produk ini bersama sampah rumah tangga Anda.  
Periksa peraturan pemerintah setempat tentang saran dan fasilitas daur ulang.

MS

Lindungi alam sekitar dengan tidak melupuskan produk ini bersama sisa isi rumah anda.  
Rujuk pihak berkuasa tempatan anda tentang nasihat dan kemudahan kitar semula.





EN

WARNING: This product contains a Button or Coin Cell Battery.

A swallowed Button or Coin Cell battery can cause internal chemical burns in as little as two hours and lead to death. Dispose of used batteries immediately. Keep new and used batteries away from children. If you think batteries might have been swallowed or placed inside any part of the body, seek immediate medical attention.

DE

ACHTUNG: Dieses Produkt enthält eine Knopfzellenbatterie.

Eine verschluckte Knopfzellenbatterie kann innere chemische Verbrennungen verursachen und in weniger als zwei Stunden zum Tod führen. Entsorge umgehend gebrauchte Batterien. Halte neue und gebrauchte Batterien von Kindern fern. Wenn du glaubst, dass Batterien verschluckt wurden oder sich in einem Körperteil befinden, hole umgehend medizinische Hilfe.

FR

AVERTISSEMENT : Ce produit contient une pile bouton.

L'ingestion d'une pile bouton peut provoquer des brûlures chimiques internes en seulement deux heures et provoquer la mort. Jeter immédiatement les piles usagées. Conserver les piles neuves et usagées hors de portée des enfants. Si vous suspectez l'ingestion d'une pile ou sa présence où que ce soit à l'intérieur du corps, consultez immédiatement un médecin.

IT

ATTENZIONE: questo prodotto contiene una batteria a bottone.

Se inghiottita, una batteria a bottone può causare ustioni chimiche interne in sole due ore, con possibile morte. Smltare immediatamente le batterie usate. Tenere le batterie nuove e usate lontano dai bambini. Se si pensa che una batteria sia stata inghiottita o inserita in una parte del corpo, rivolgersi immediatamente a un medico.

NL

WAARSCHUWING: dit product bevat een knoopcelbatterij.

Als een knoopcelbatterij wordt ingeslikt, kan deze binnen twee uur chemische brandwonden veroorzaken in het lichaam. Het inslikken van een dergelijke batterij kan zelfs leiden tot overlijden. Gooi gebruikte batterijen onmiddellijk weg. Bewaar nieuwe en gebruikte batterijen buiten bereik van kinderen. Als je denkt dat een kind batterijen heeft ingeslikt of ze in een lichaamsopening heeft gestopt, raadpleeg je direct een arts.

ES

ADVERTENCIA: Este producto contiene una pila de botón.

Ingerir una pila de botón puede dar lugar a quemaduras químicas internas en tan sólo dos horas y provocar la muerte. Las pilas usadas deben desecharse inmediatamente. Mantenga las pilas nuevas y usadas fuera del alcance de los niños. Si sospecha de la ingestión o la introducción de pilas en cualquier parte del cuerpo, busque atención médica inmediatamente.

DA

ADVARSEL: Dette produkt indeholder et knap- eller møntcellebatteri.

Hvis et knap- eller møntcellebatteri sluges, kan det forårsage indvendige ætsninger på blot to timer og medføre døden. Bortskaf brugte batterier omgående. Hold både nye og brugte batterier uden for børns rækkevidde. Hvis du har mistanke om, at batterierne kan være blevet slugt eller kommet ind i nogen del af kroppen, skal du omgående søge lægehjælp.

IS

VIÐVÖRUN: Þessi vara inniheldur hnapparafhlöðu eða flata rafhlöðu.

Ef hnapparafhlaða eða flöt rafhlaða er gleypst getur hún valdið innvortis efnabruna á innan við tveimur klukkustundum og leitt til dauða. Fargaðu notuðum rafhlöðum tafarlaust. Geymdu nýjar og notaðar rafhlöður þar sem börn ná ekki til. Ef þú telur að rafhlöður hafi verið gleyptar eða á annan hátt komist inn í einhvern hluta líkamans skaltu tafarlaust leita læknaaðstoðar.

FI

VAROITUS: Tämä tuote sisältää pienen tai isokokaisen nappipariston.

Nielytynä pieni tai isokokoinen nappiparisto voi aiheuttaa sisäisiä kemiallisia palovammoja jo kahden tunnin kuluessa ja johtaa kuolemaan. Käytetyt paristot on toimitettava heti keräyspisteeseen. Pidä uudet ja käytetyt paristot poissa lasten ulottuvilta. Jos epäilet jonkun nielelleen pariston tai laitteensa pariston leukoosa, vie hänet välittömästi lääkäriin.

SV

WARNING: Denna produkt innehåller ett knapp- eller myntcells batteri.

Förtäring av ett knapp- eller myntcells batteri kan orsaka inre kemiska brännskador på så kort tid som två timmar och leda till döden. Kassera förbrukade batterier omedelbart. Förvara nya och använda batterier utom räckhåll för barn. Om du tror att batterierna kan ha svalts eller placerats inuti någon del av kroppen, sök omedelbart läkarvård.

NO

ADVARSEL: Dette produktet inneholder et knapp- eller myntcellebatteri.

Ved svelging kan knapp- eller myntcellebatterier gi kjemisk brannskade innvendig på bare to timer og føre til død. Brukte batterier skal avhendes øyeblikkelig. Nye og brukte batterier skal oppbevares utilgjengelig for barn. Hvis du tror at batterier har blitt svelget eller puttet inn andre steder i kroppen, må du kontakte lege øyeblikkelig.

PT

AVISO: Este produto contém uma pilha tipo botão ou moeda.

Uma pilha tipo botão ou moeda que tenha sido engolidá pode provocar queimaduras químicas internas em menos de duas horas e levar à morte. Elimine as pilhas usadas imediatamente. Mantenha as pilhas novas e usadas fora do alcance das crianças. Se pensa que as pilhas podem ter sido engolidas ou colocadas no interior de alguma parte do corpo, procure de imediato assistência médica.

EL

ΠΡΟΕΙΔΟΠΟΙΗΣΗ: Αυτό το προϊόν περιέχει μία Στρογγυλή Μπαταρία Μεγέθους Κομπιού ή Κέρματος.

Η κατάποση μιας Στρογγυλής Μπαταρίας Μεγέθους Κομπιού ή Κέρματος μπορεί να προκαλέσει εσωτερικά χημικά εγκαυματα σε μόλις δύο ώρες και να οδηγήσει σε θάνατο. Πετάξτε αμέσως τις χρησιμοποιημένες μπαταρίες. Κρατήστε τις καινούργιες και τις χρησιμοποιημένες μπαταρίες μακριά από τα παιδιά. Εάν νομίζετε ότι κάποια μπαταρία έχει καταποθεί ή τοποθετηθεί εντός οποιουδήποτε μέρους του σώματος, ζητήστε αμέσως ιατρική βοήθεια.

JA

警告：本製品には、ボタン型またはコイン型の電池が使用されています。ボタン型またはコイン型電池は誤飲すると2時間以内に体内で科学火傷を起こし、死に至る恐れがあります。使用済みの電池は直ちに廃棄してください。新しい電池および使用済み電池は、どちらもお子様の手の届かないところに保管してください。電池を誤飲した恐れがある、または電池が身体のだこかにいった恐れがある場合は、直ちに医師の診察を受けてください。

ZH

警告：本品内含一颗纽扣电池。

吞咽的纽扣电池仅在两小时内就会引起体内化学灼伤并导致死亡！请立即处理使用过的电池。请将新、旧电池放置到儿童接触不到的地方。如果电池被不慎吞下，或被置入身体的任何一个部位，请立即就医！

KO

경고: 이 제품에는 버튼 또는 코인 셀 배터리가 포함되어 있습니다. 코인 셀 배터리를 삼킬 경우, 빠르면 2시간 이내에 체내에서 화학적 화상이 일어나고 심하면 사망에 이를 수 있습니다. 다 쓴 배터리는 즉시 폐기하십시오. 배터리를 어린이의 손에 닿지 않는 곳에 보관하십시오. 배터리를 삼켰거나 신체 어느 부위에든 들어간 것으로 판단될 경우, 즉각 의사의 도움을 구하십시오.

RU

ПРЕДОСТЕРЕЖЕНИЕ. Эта игрушка работает от батарейки таблеточного или кнопочного типа.

Проглатывание батарейки таблеточного или кнопочного типа может (в течение двух часов) вызвать химические ожоги внутренних органов и привести к летальному исходу. Своевременно утилизируйте использованные батарейки. Храните новые и использованные батарейки в местах, недоступных для детей. Если у вас есть основания полагать, что ребенок проглотил батарейку или она попала внутрь какой-либо части его тела, немедленно обратитесь за медицинской помощью.

PL

OSTRZEŻENIE: w tym produkcie znajduje się płaska okrągła bateria.

Połknięcie takiej baterii może spowodować chemiczne oparzenia wewnętrzne już po dwóch godzinach, a także doprowadzić do śmierci. Gdy bateria się zużyje, należy ją natychmiast zutylizować. Nowe i używane baterie należy przechowywać z dala od dzieci. W przypadku stwierdzenia, że baterie mogły zostać połknięte lub inaczej trafić do organizmu, należy natychmiast poszukać pomocy lekarskiej.

CZ

VAROVÁNÍ: Tento výrobek obsahuje knoflíkovou nebo mincovou baterii.

Spolknutí knoflíkové nebo mincové baterie může během pouhých 2 hodin způsobit vnitřní poleptání sliznice a v některých případech mít za následek smrt. Použité baterie ihned vyjměte a zlikvidujte. Nové i použité baterie uchovávejte mimo dosah dětí. V případě spolknutí či uvíznutí baterie v některé části těla okamžitě vyhledejte lékařskou pomoc.

SK

UPOZORNENIE: Tento produkt obsahuje gombíkovú alebo mincovú batériu.

Prehltnutie gombíkovej alebo mincovej batérie môže spôsobiť vnútorné chemické poranenie už do dvoch hodín a viesť k úmrtiu. Použité batérie ihneď vyhodte. Nové aj použité batérie uchovávajte mimo dosahu detí. Ak si myslíte, že mohlo dôjsť k prehltnutiu batérie alebo sa batéria mohla dostať do vnútra ktorejkoľvek časti tela, okamžite vyhľadajte lekársku pomoc.

HU

FIGYELMEZTETÉS: Ez a termék gomeblemet illetve lapos gomeblemet tartalmaz!

A lenyelt gomeblem vagy lapos gomeblem akár két óra alatt is belső vegyi sérüléseket okozhat, ami halálhoz vezethet. Az elhasznált elemeket azonnal dobja ki! Az új és a használt elemeket ne adja gyermekek kezébe! Ha úgy gondolja, hogy valaki lenyelt egy elemet, vagy bekerült valakinek valamely testrészébe, akkor azonnal kérjen orvosi segítséget!

UA

ОБЕРЕЖНО. Продукт містить мініатюрну батарейку типу «таблетка».

Якщо проковтнути мініатюрну батарейку, вона може спричинити внутрішні хімічні опіки протягом двох годин і призвести до смерті. Негайно утилізуйте використані батарейки. Зберігайте нові та використані батарейки недоступними для дітей. Якщо вам здається, що дитина проковтнула батарейку чи вона опинилася в будь-якій частині тіла дитини, негайно зверніться до лікаря.



HR  
**UPOZORENJE:** Ovaj proizvod sadrži gumbastu bateriju ili bateriju oblika kovanice. Ako se gumbasta baterija ili baterija oblika kovanice proguta, za samo dva sata može uzrokovati unutarnje kemijske opekline i izazvati smrt. Iskoristene baterije odmah odložite u otpad. Čuvajte nove i stare baterije dalje od djece. Ako mislite da je baterija progutana ili je dospjela u bilo koji dijel tijela, odmah zatražite liječničku pomoć.

SR  
**UPOZORENJE:** Овај производ садржи дугмасту батерију. Прогутана дугмаста батерија може да доведе до интерних хемијских опекотина већ за два сата и доводи до смрти. Одмах одложите искоришћене батерије у отпад. Чувајте нове и искоришћене батерије ван домаћаја дече. Ако мислите да је дошло до гутања батерија или стављања у било који део тела, одмах потражите помоћ лекара.

МК  
**ПРЕДУПРЕДУВАЊЕ:** Овој производ садржи батерија тип копче или тип монета. Проглотувањето на батерија тип копче или тип монета може да предизвика внатрешно хемиско горење во рок од два часа и да доведе до смрт. Исфрлете ги веднаш искористените батерији. Држете ги новите и користените батерији подалеку од деца. Ако мислите дека е можно батериите да се проглотани или поставени во кој било дел на телото, веднаш побарајте медицинска помош.

SL  
**OPOZORILO:** Ta izdelek vsebuje gumbasto baterijo. Če oseba požre gumbasto baterijo, lahko to povzroči kemične opekline notranjih organov že v dveh urah po zaužitju. Tovrstne poškodbe lahko vodijo v smrt. Iztrošene baterije takoj zavrzite. Pazite, da nove ali iztrošene baterije ne bodo v dosegu otrok. Če menite, da je oseba zaužila baterijo ali si jo vstavila v kateri koli del telesa, takoj poiščite zdravniško pomoč.

RO  
**AVERTIZARE:** Acest produs conține o baterie de tip pastilă. Înghițirea unei baterii de tip pastilă poate cauza arsuri chimice interne în doar două ore, ducând la deces. Debarasați-vă imediat de bateriile uzate. Nu lăsați bateriile noi și uzate la îndemâna copiilor. Dacă credeți că bateriile ar fi putut fi înghițite sau ar fi putut ajunge în interiorul oricărei părți a corpului, solicitați imediat asistență medicală.

BG  
**ПРЕДУПРЕЖДЕНИЕ:** Този продукт съдържа батерия тип „копче“ или „монета“. При поглъщане батериите тип „копче“ или „монета“ могат да предизвикат вътрешни химически изгаряния в рамките на по-малко от два часа и да доведат до смърт. Незабавно изхвърляйте използваните батерии. Дръжте новите и стари батерии далеч от деца. Ако смятате, че е възможно батериите да са били поглънати или да са попаднали където и да е вътре в тялото, потърсете незабавно медицинска помощ.

LV  
**BRĪDINĀJUMS.** Šim produktam ir pogas jeb monētas tipa akumulators. Ja pogas jeb monētas tipa akumulators tiek norīts, tas jau divu stundu laikā var izraisīt iekšējus ķīmiskus apdegumus un izraisīt nāvi. Nekavējoties utilizējiet izlietotos akumulatorus. Jaunus un lietotus akumulatorus glabājiet bērniem nepieejamā vietā. Ja uzskatāt, ka akumulators varētu būt norīts vai ievietots kādā ķermeņa daļā, nekavējoties vērsieties pēc medicīniskās palīdzības.

ET  
**HOIATUS!** See toode sisaldab nõõp- või müntpatareid. Alla neelatud nõõp- või müntpatarei võib tekitada sisemisi keemilisi põletusi kõigest kahe tunniga ning põhjustada surma. Kõrvaldage kasutatud patareid viivitamatult. Hoidke uusi ja kasutatud patareid lastele kättesaamatus kohas. Kui arvate, et keegi on patareid alla neelanud või need on sattunud mõnda kehaosasse, pöörduge kohe arsti poole.

LT  
**JSPĖJIMAS.** Šiame gaminyje yra sagos arba monetos formos baterija. Praryta sagos arba monetos formos baterija gali sukelti vidinius cheminius nudeginimus greičiau nei per dvi valandas ir galiausiai sukelti mirtį. Panaudotas baterijas nedelsiant utilizuokite. Naujas ir panaudotas baterijas laikykite atokiau nuo vaiku. Jei manote, kad vaikas galėjo praryti arba įsprausti bateriją sau j kūną, nedelsdami kreipkitės medicininės pagalbos.

TR  
**UYARI!** Bu ürün bir düğme pil içerir. Yutulmuş pil, iki saat gibi kısa bir sürede iç kimyasal yanıklara neden olabilir ve ölüme yol açabilir. Kullanılmış pilleri derhal atın. Yeni ve kullanılmı pilleri çocuklardan uzak tutun. Pillerin yutulmuş ya da vücudun başka bir yerine sokulmuş olabileceğini düşünüyorsanız derhal doktora başvurun.

AR  
**تحذير:** يحتوي هذا المنتج على بطارية خلايا قرضية أو بطارية خلايا على شكل عملة. قد يؤدي ابتلاع بطارية خلايا قرضية أو بطارية خلايا على شكل عملة إلى حدوث حروق كيميائية داخلية خلال فترة قصيرة لا تتجاوز ساعتين وقد يؤدي إلى الوفاة. يرجى التخلص من البطاريات المستعملة على الفور مع الاحتفاظ بالبطاريات الجديدة والمستعملة بعيداً عن متناول الأطفال. إذا كنت تعتقد أن البطاريات تم ابتلاعها أو إدخالها إلى أي جزء من أجزاء الجسم، فاطلب المساعدة الطبية على الفور.

ID  
**PERINGATAN:** Produk ini berisi Baterai Sel Kancing. Baterai Sel Kancing yang tertelan dapat mengakibatkan luka bakar kimiawi dalam tubuh minimal setelah dua jam dan dapat mengakibatkan kematian. Segera buang baterai yang sudah tidak digunakan. Jauhkan baterai baru maupun bekas dari jangkauan anak-anak. Jika Anda curiga baterai telah tertelan atau masuk ke dalam tubuh, segeralah minta bantuan dokter.

MS  
**AMARAN:** Produk ini mengandungi Bateri Sel Butang atau Syiling. Tertelan bateri Sel Butang atau Syiling boleh mengakibatkan lecuran kimia dalam dalam tempoh sekurang-kurangnya dua jam dan menyebabkan kematian. Buang bateri terpakai dengan serta-merta. Jauhkan bateri baharu dan terpakai daripada kanak-kanak. Jika anda mendapati bateri mungkin telah ditelan atau termasuk ke dalam mana-mana bahagian badan, dapatkan rawatan perubatan dengan segera.

1:1  
 2x LR 41 1.5V

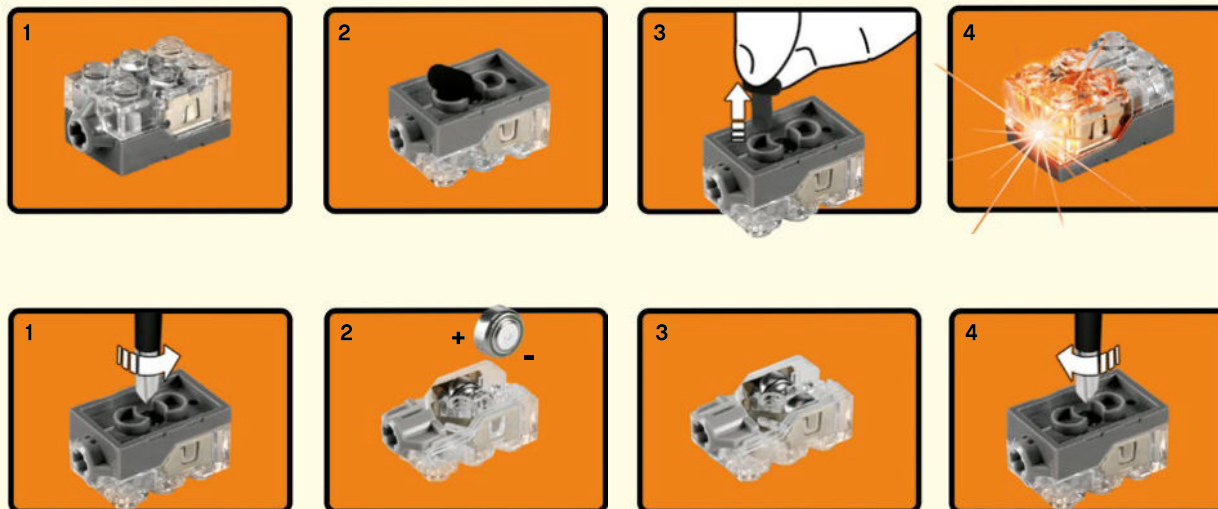



# MONKIE KID 悟空小侠™



80015



80009



80008



80014



80007



80013



80012



80016



80011



80010

1x 6301803	1x 383321	2x 362221	2x 6168644	2x 6092583	1x 6283869	1x 6170421	10x 6051508		
1x 6168642	1x 6296344	2x 6302650	6x 6271167	2x 302324	1x 6303411	1x 4221775	2x 4653822		
1x 6316325	1x 6177507	1x 6301910	1x 6296328	4x 366524	1x 623224	2x 306226	2x 6195273		
1x 6296332	1x 4651524	1x 6301910	1x 6271772	1x 9553	1x 623224	5x 4529236	2x 459926		
1x 6296332	6x 4142865	1x 6296954	1x 6296304	5x 6129504	1x 408324	1x 6168646	4x 6273589		
			1x 6296303	4x 6195184	1x 626283	3x 6278152	2x 4504382		
1x 6296331	1x 6296347	1x 6296954	1x 6296303	4x 4501232	1x 626283	4x 6210270	8x 654126		
			1x 6296314	1x 306824	2x 371024	1x 6303189	16x 300526		
1x 306801	2x 6305047	2x 6189130		4x 6329889	2x 4164073	2x 4533771	2x 6234695		
				2x 302424	6x 6130007	5x 4548180	4x 6156414		
1x 6126046	4x 370021	4x 6189130	4x 6329889	1x 4161331	6x 242024	21x 4278359	2x 4177431		
		2x 300221		1x 4160868	2x 6267046	1x 4253815	4x 4184169		
2x 4114306	2x 306921	1x 6130002		2x 614324	2x 407924	8x 6069000	10x 6138173		
				1x 4519010	1x 6305325	1x 6296345	21x 370026		
2x 6321305	1x 6296308	11x 4206482	1x 4161331	2x 614324	1x 6305325	2x 6266320	8x 6147050		
1x 306221	3x 6219819	2x 6057802	1x 4161331	1x 4519010	1x 6305325				
1x 459921	2x 6209519	2x 6057802	1x 4160868	2x 614324	1x 6305325				
			2x 614324	1x 4519010	1x 6305325				
8x 407021	1x 303421	1x 9341	2x 614324	2x 614324	1x 6305325				
1x 6177505	2x 6147702	6x 4514553	2x 614324	2x 614324	1x 6305325				

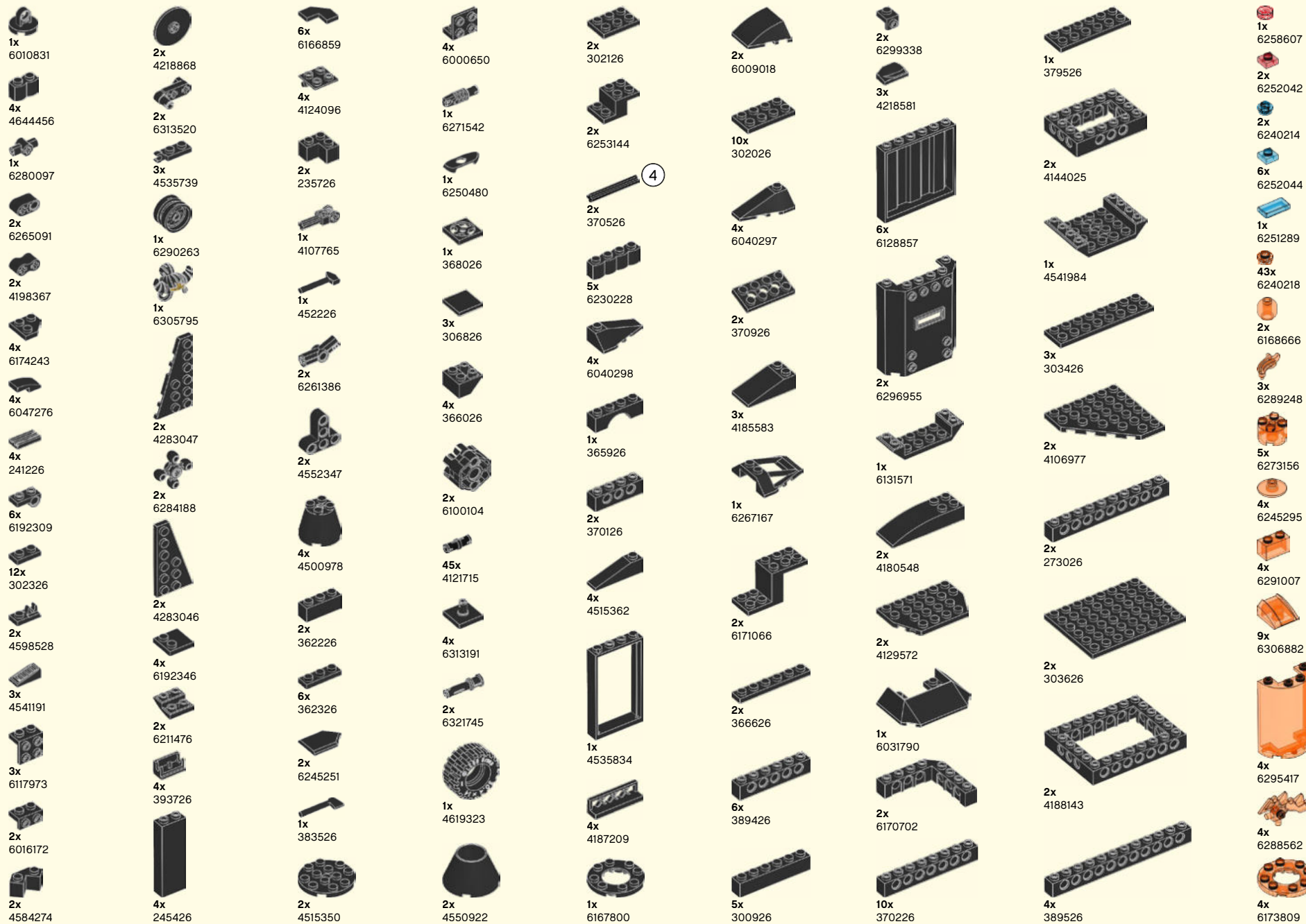

4x 6296894	1x 6126082	4x 6282158	2x 6271165	8x 6328192	4x 6296951	4x 6115080	2x 6308045
4x 4533772	1x 4490127	4x 6328063	1x 6278156	1x 6309187	2x 4529240	2x 4516546	5x 6000606
1x 6092956	8x 6045988	2x 6321743	4x 6275844	2x 6177349	1x 6231765	6x 6019987	2x 6271356
1x 4540203	4x 6043639	1x 6225808	20x 4211483	2x 6199889	2x 6278155	2x 4211111	1x 4581225
1x 4211526	2x 4211815	1x 6225808	2x 4211399	7x 6070763	1x 6100030	2x 6039479	3x 6123814
4x 4211807	2x 4211815	3x 4211613	4x 4211476	8x 6249742	4x 6071226	10x 6164073	6x 4211094
2x 6320297	2x 6267048	2x 6176242	2x 6248890	12x 6103415	2x 6158469	2x 6168776	5x 4211055
4x 6206249	9x 4654577	2x 6176242	2x 4211541	2x 6292373	6x 6315300	4x 4210762	1x 4211060
4x 6123809	2x 6183782	1x 6108560	13x 4211357	5x 6037652	4x 6221607	2x 6178919	3x 4521187
1x 4556157	2x 6097090	2x 6186129	1x 6212007	2x 6282101	6x 6296892	4x 4210797	4x 6258991
4x 6198932	4x 4640536	2x 6211969	2x 6282000	8x 6037658	1x 4210782	4x 4211135	4x 4210751
1x 4211632	5x 6043656	2x 6211408	2x 6312350	2x 6109929	1x 4210788	2x 4210763	2x 4246896
2x 6319336	1x 6313114	2x 4211522	2x 6208727	2x 6135494	2x 6055313	2x 6319332	1x 6306622
	4x 4211398		1x 4583299	4x 6159763	1x 4567887	5x 6214341	1x 6324639
					19x 4211042	1x 6117972	4x 4211043

6x 6083620  
 1x 4211103  
 6x 4211001  
 2x 4528323  
 2x 4211097  
 2x 6331689  
 1x 4211006  
 4x 4210897  
 1x 4560184  
 1x 6311445  
 3x 4542618  
 4x 4211056

1x 6186825  
 10x 4211002  
 4x 4495931  
 2x 4521572  
 4x 4210998  
 2x 4211115  
 9x 4210997  
 2x 4211134  
 1x 4209726  
 2x 6262023

7

8x 4211061  
 1x 4595708  
 4x 4211067  
 1x 4299022  
 4x 4522937  
 2x 4211114  
 2x 6304966  
 1x 6037634  
 6x 6208834

13

2x 6158415  
 1x 6234116  
 8x 6156875  
 1x 6168708  
 2x 6197015  
 2x 6296349  
 7x 6208447  
 2x 6236391  
 2x 6263553  
 1x 6302555  
 4x 6248873  
 2x 6122170

5x 6199891  
 14x 4567509  
 7x 6030534  
 4x 4566607  
 1x 6296316  
 6x 6166863  
 2x 6250643  
 8x 6092604  
 6x 6107204  
 2x 4655690  
 13x 4655695  
 6x 6022072  
 2x 6109814  
 8x 6047422  
 3x 6182217

6x 6231376  
 1x 6109766  
 6x 6103449  
 2x 6185995  
 9x 6167464  
 2x 6289698  
 2x 6167472  
 1x 6030277  
 4x 4655691  
 1x 6214214  
 1x 4633691  
 3x 4619636  
 2x 4632100  
 2x 6044636

1x 6170470  
 1x 6162580  
 1x 6003147  
 10x 4529247  
 3x 6190252  
 4x 6173139  
 2x 6083975  
 6x 6270109  
 2x 6092672  
 1x 6286094  
 2x 6285441  
 2x 6289765

1x 6274742  
 1x 6303630  
 1x 6301802  
 2x 6294553  
 4x 4121739  
 2x 6061676  
 2x 4153827  
 1x 6240515  
 1x 6302682

2x 6293280  
 1x 6296942  
 2x 6301397  
 1x 6031821  
 2x 6245265  
 4x 6252040  
 2x 6251286  
 1x 6315014

3.2



**Customer Service**  
 Kundenservice  
 Service Consommateurs  
 Servicio Al Consumidor

[LEGO.com/service](http://LEGO.com/service) or dial



: 00800 5346 5555  
 : 1-800-422-5346



# MONKIE KID 悟空小侠™



LEGO and the LEGO logo are trademarks of the/son des marques de commerce du/son marcas registradas de LEGO Group. ©2020 The LEGO Group. 6333426/6333427